

Quick Start Guide & Manual



IP Motorized 5MP Dome IPOD-ELS5IRZA-AI-EP



MOBILE APPS
FREE MOBILE APPS
FOR ANDRIOD AND IOS



FREE TECH SUPPORT
FAST SERVICE SUPPORT

Quick Start Guide



Foreword

General

This manual introduces the functions, installation, and operations of the camera.

Safety Instructions

The following categorized signal words with defined meaning might appear in the manual.

Signal Words	Meaning
 WARNING	Indicates a medium or low potential hazard which, if not avoided, could result in slight or moderate injury.
 CAUTION	Indicates a potential risk which, if not avoided, could result in property damage, data loss, lower performance, or unpredictable result.
 NOTE	Provides additional information as the emphasis and supplement to the text.

Revision History

Version	Revision Content	Release Time
V1.0.0	First release.	May 2019

Privacy Protection Notice

As the device user or data controller, you might collect personal data of other such as face, fingerprints, car plate number, Email address, phone number, GPS and so on. You need to be in compliance with the local privacy protection laws and regulations to protect the legitimate rights and interests of other people by implementing measures include but not limited to: providing clear and visible identification to inform data subject the existence of surveillance area and providing related contact.

About the Manual

- The manual is for reference only. If there is inconsistency between the manual and the actual product, the actual product shall prevail.
- We are not liable for any loss caused by the operations that do not comply with the manual.
- The manual would be updated according to the latest laws and regulations of related regions. For detailed information, see the paper manual, CD-ROM, QR code or our official website. If there is inconsistency between paper manual and the electronic version, the electronic version shall prevail.
- All the designs and software are subject to change without prior written notice. The product updates might cause some differences between the actual product and the manual. Please

contact the customer service for the latest program and supplementary documentation.

- There still might be deviation in technical data, functions and operations description, or errors in print. If there is any doubt or dispute, please refer to our final explanation.
- Upgrade the reader software or try other mainstream reader software if the manual (in PDF format) cannot be opened.
- All trademarks, registered trademarks and the company names in the manual are the properties of their respective owners.
- Please visit our website, contact the supplier or customer service if there is any problem occurred when using the device.
- If there is any uncertainty or controversy, please refer to our final explanation.

Important Safeguards and Warnings

Electrical Safety

- All installation and operation should conform to your local electrical safety codes.
- The power source shall conform to the Safety Extra Low Voltage (SELV) standard, and supply power with rated voltage which conforms to Limited power Source requirement according to IEC60950-1. Please note that the power supply requirement is subject to the device label.
- Make sure the power supply is correct before operating the device.
- A readily accessible disconnect device shall be incorporated in the building installation wiring.
- Prevent the power cable from being trampled or pressed, especially the plug, power socket and the junction extruded from the device.

Environment

- Do not aim the device at strong light to focus, such as lamp light and sun light; otherwise it might cause over brightness or light marks, which are not the device malfunction, and affect the longevity of Complementary Metal-Oxide Semiconductor (CMOS).
- Do not place the device in a damp or dusty environment, extremely hot or cold temperatures, or the locations with strong electromagnetic radiation or unstable lighting.
- Keep the device away from any liquid to avoid damage to the internal components.
- Keep the indoor device away from rain or damp to avoid fire or lightning.
- Keep sound ventilation to avoid heat accumulation.
- Transport, use and store the device within the range of allowed humidity and temperature.
- Heavy stress, violent vibration or water splash are not allowed during transportation, storage and installation.
- Pack the device with standard factory packaging or the equivalent material when transporting the device.
- Install the device in the location where only the professional staff with relevant knowledge of safety guards and warnings can access. The accidental injury might happen to the non-professionals who enter the installation area when the device is operating normally.

Operation and Daily Maintenance

- Do not touch the heat dissipation component of the device to avoid scald.
- Carefully follow the instructions in the manual when performing any disassembly operation about the device; otherwise, it might cause water leakage or poor image quality due to unprofessional disassemble. Please contact after-sale service for desiccant replacement if there is condensed fog found on the lens after unpacking or when the desiccant turns green. (Not all models are included with the desiccant).

- It is recommended to use the device together with lightning arrester to improve lightning protection effect.
- It is recommended to ground the device to enhance reliability.
- Do not touch the image sensor directly (CMOS). Dust and dirt could be removed with air blower, or you can wipe the lens gently with soft cloth that moistened with alcohol.
- Device body can be cleaned with soft dry cloth, which can also be used to remove stubborn stains when moistened with mild detergent. To avoid possible damage on device body coating which could cause performance decrease, do not use volatile solvent such as alcohol, benzene, diluent and so on to clean the device body, nor can strong, abrasive detergent be used.
- Dome cover is an optical component, do not touch or wipe the cover with your hands directly during installation or operation. For removing dust, grease or fingerprints, wipe gently with moisten oil-free cotton with diethyl or moisten soft cloth. You can also air blower to remove dust.



- Please strengthen the protection of network, device data and personal information by adopting measures which include but not limited to using strong password, modifying password regularly, upgrading firmware to the latest version, and isolating computer network. For some device with old firmware versions, the ONVIF password will not be modified automatically along with the modification of the system password, and you need to upgrade the firmware or manually update the ONVIF password.
- Use standard components or accessories provided by manufacturer and make sure the device is installed and maintained by professional engineers.
- The surface of the image sensor should not be exposed to laser beam radiation in an environment where a laser beam device is used.
- Do not provide two or more power supply sources for the device unless otherwise specified. A failure to follow this instruction might cause damage to the device.

Regulatory Information

The regulatory information herein might vary according to the model you purchased. Some information is only applicable for the country or region where the product is sold.

FCC Information



Changes or modifications not expressly approved by the party responsible for compliance could void the user's authority to operate the equipment.

FCC conditions:

This device complies with part 15 of the FCC Rules. Operation is subject to the following two conditions:

- This device may not cause harmful interference.
- This device must accept any interference received, including interference that may cause undesired operation.

FCC compliance:

This equipment has been tested and found to comply with the limits for a digital device, pursuant to part 15 of the FCC Rules. This equipment generate, uses and can radiate radio frequency energy and, if not installed and used in accordance with the instructions, may cause harmful interference to radio communication.

- For class A device, these limits are designed to provide reasonable protection against harmful interference in a commercial environment. Operation of this equipment in a residential area is likely to cause harmful interference in which case the user will be required to correct the interference at his own expense.
- For class B device, these limits are designed to provide reasonable protection against harmful interference in a residential installation. However, there is no guarantee that interference will not occur in a particular installation. If this equipment does cause harmful interference to radio or television reception, which can be determined by turning the equipment off and on, the user is encouraged to try to correct the interference by one or more of the following measures:
 - Reorient or relocate the receiving antenna.
 - Increase the separation between the equipment and receiver.
 - Connect the equipment into an outlet on a circuit different from that to which the receiver is connected.
 - Consult the dealer or an experienced radio/TV technician for help.

Table of Contents

Foreword	I
Important Safeguards and Warnings	III
Regulatory Information	V
1 Cable	1
2 Network Configuration	2
2.1 Initializing Device	2
2.2 Modifying Device IP Address	3
2.3 Logging in Web Interface	4
3 Installation	5
3.1 Packing List.....	5
3.2 Dimension	5
3.3 Installing Device.....	6
3.3.1 Installation Type	6
3.3.2 Detaching the Enclosure	6
3.3.3 Installing SD Card (Optional).....	6
3.3.4 Attaching Device	7
3.3.5 Installing Waterproof Connector (Optional).....	8
3.3.6 Adjusting Lens Angle	9

1 Cable



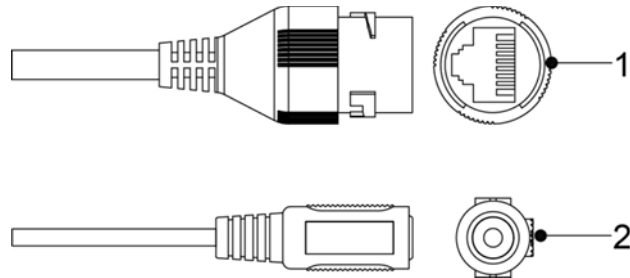

- Cable type might vary with different devices, and the actual product shall prevail.
- Waterproof all the cable joints with insulating tape and waterproof tape to avoid short circuit and water damage. For the detailed operation, see the *FAQ Manual*.

Figure 1-1 Cable list



For more information about cable ports, see Table 1-1.

Table 1-1 Cable information

No.	Port Name	Description
1	Ethernet port	<ul style="list-style-type: none"> • Connects to network with network cable. • Provides power to the device with PoE.  <p>PoE is available on select models.</p>
2	12V DC power input	<p>Inputs 12V DC power. Please be sure to supply power as instructed in the Guide.</p>  <p>Device abnormality or damage could occur if power is not supplied correctly.</p>

2 Network Configuration

Device initialization and IP address setting can be finished with the "ConfigTool" or in web interface. For more information, see the *Web Operation Manual*.



- Device initialization is available on select models, and it is required at first use or after the device being reset.
- Device initialization is available only when the IP addresses of the device (192.168.1.108 by default) and the PC stay in the same network segment.
- Plan useable network segment properly to connect the device to the network.
- The following figures and interfaces are for reference only, and the actual product shall prevail.

2.1 Initializing Device

Step 1 Double-click "ConfigTool.exe" to open the tool.

Step 2 Click .

The **Modify IP** interface is displayed. See Figure 2-1.

Figure 2-1 Modify IP

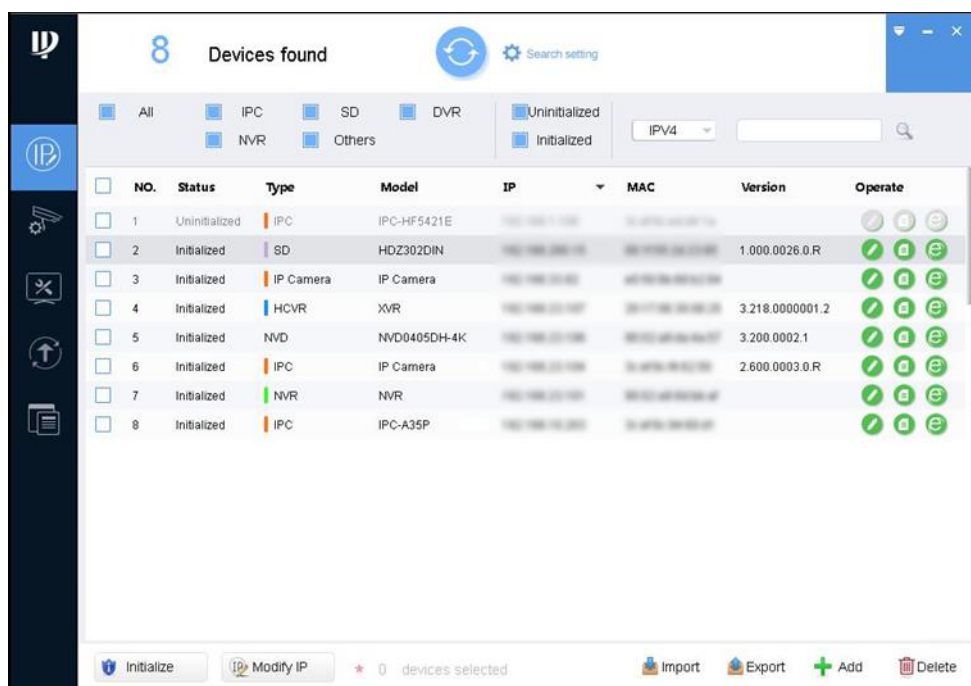

Step 3 Click Search setting.

The **Setting** interface is displayed.

Step 4 Enter the start IP address and end IP address of the network segment in which you want to search devices, and then click **OK**.

All the devices found in the network segment are listed.

Step 5 Select one or several devices with **Status** shows **Uninitialized**, and then click **Initialize**.

The **Device initialization** interface is displayed.

Step 6 Select the devices that need initialization, and then click **Initialize**.

The password setting interface is displayed. See Figure 2-2.

Figure 2-2 Password setting

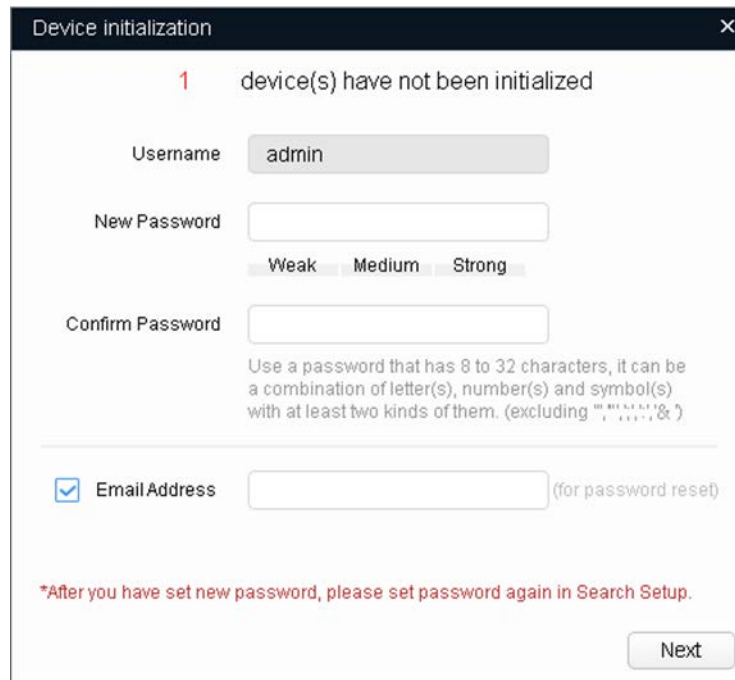

The screenshot shows a window titled "Device initialization" with a close button (X) in the top right corner. At the top, a red "1" icon is followed by the text "device(s) have not been initialized". Below this, there are three input fields: "Username" with the value "admin", "New Password" (empty), and "Confirm Password" (empty). Under the "New Password" field, there are three radio buttons labeled "Weak", "Medium", and "Strong". Below the "Confirm Password" field, there is a note: "Use a password that has 8 to 32 characters, it can be a combination of letter(s), number(s) and symbol(s) with at least two kinds of them. (excluding ', \", ;, & ')". At the bottom left, there is a checked checkbox labeled "EmailAddress" followed by an empty input field and the text "(for password reset)". At the bottom right, there is a "Next" button. At the very bottom, there is a red asterisk followed by the text: "*After you have set new password, please set password again in Search Setup."

Step 7 Set and confirm the password of the devices, then enter a valid email address, and then click **Next**.

The final setting interface is displayed.



Password can be modified or reset in **System Settings**.

Step 8 Select the options according to your needs, and then click **OK**.

The **Initialization** interface is displayed after initialization is completed. Click the success icon (✓) or the failure icon (⚠) for the details.

Step 9 Click **Finish**.

The device status in the **Modify IP** interface (Figure 2-1) turns to **Initialized**.

2.2 Modifying Device IP Address



- You can modify IP address of one or multiple devices in one time. This section is based on modifying IP addresses in batch.
- Modifying IP addresses in batch is available only when the corresponding devices have the same login password.

Step 1 Do "Step 1" to "Step 4" in "2.1 Initializing Device" to search devices in your network segment.



After clicking **Search setting**, enter the username and password, and please make sure they are the same as what you set during initialization, otherwise there will be "wrong password" notice.

Step 2 Select the devices which IP addresses need to be modified, and then click **Modify IP**.

The **Modify IP Address** interface is displayed. See Figure 2-3.

Figure 2-3 Modify IP Address

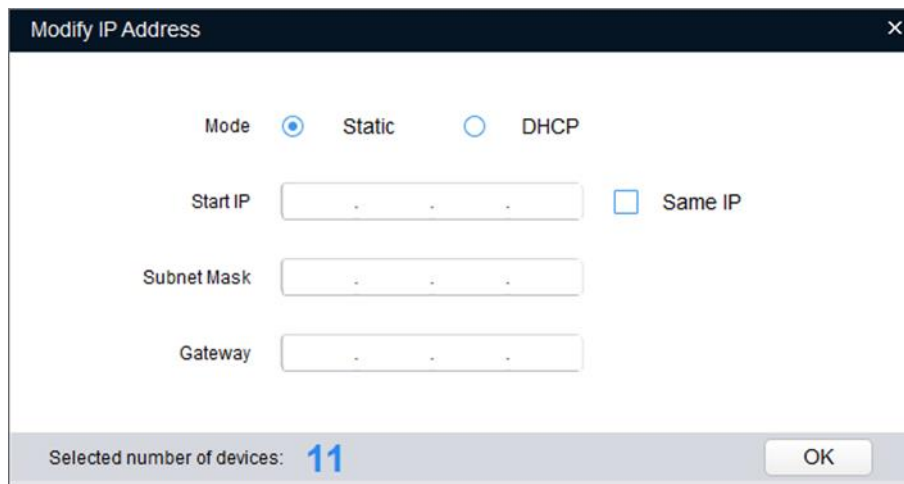

Step 3 Select **Static** mode, and then enter start IP, subnet mask, and gateway.



- IP addresses of multiple devices will be set to the same if you select the **Same IP** checkbox.
- If DHCP server is available in the network, devices will automatically obtain IP addresses from DHCP server when you select **DHCP**.

Step 4 Click **OK**.

2.3 Logging in Web Interface

Step 1 Open IE browser, then enter the IP address of the device in the address bar, and then press Enter.

If the setup wizard is displayed, finish the settings as instructed.

Step 2 Enter the user name and password in the login box, and then click **Login**.

Step 3 For first time login, click **Click Here to Download Plugin**, and then install the plugin as instructed.

The main interface is displayed when the installation is finished. See Figure 2-4.

Figure 2-4 Main interface

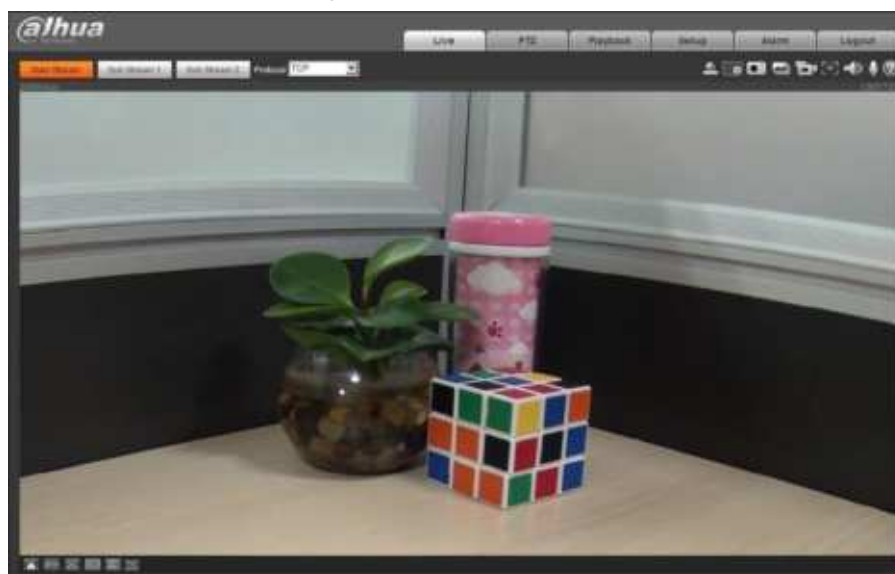

3 Installation

3.1 Packing List



- The tool required for the installation such as electric drill is not provided in the packing.
- The operation manual and related tool are contained in the disk or the QR code, and the actual packing shall prevail.

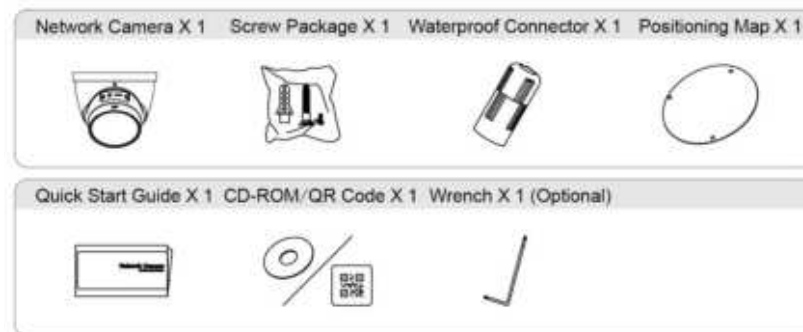

3.2 Dimension



Following figures are for reference only, and the actual product shall prevail.

(Unit: mm [in])

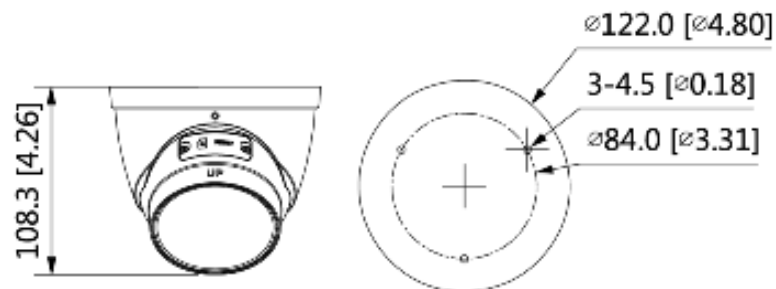

3.3 Installing Device

3.3.1 Installation Type

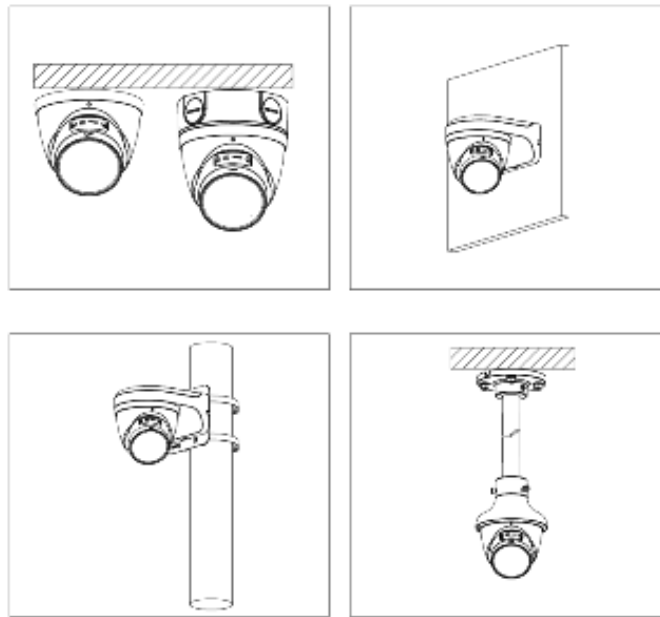

3.3.2 Detaching the Enclosure

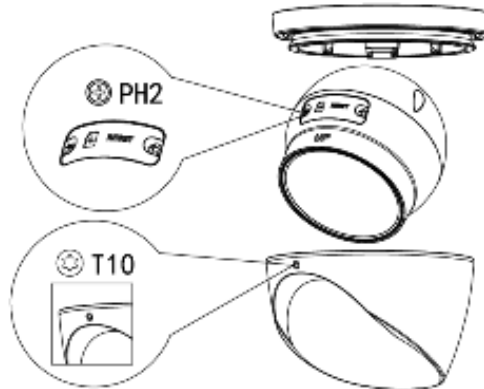

3.3.3 Installing SD Card (Optional)



- Pull the power plug off before installing or removing the SD card.
- Press and hold the RESET button for 10 s to reset the camera.

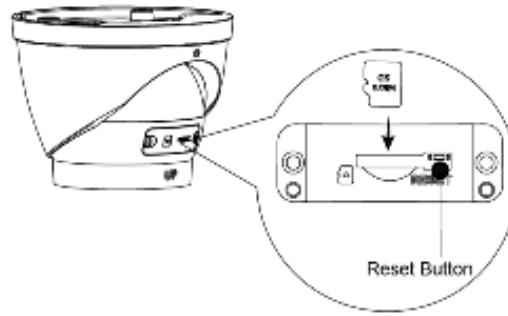

3.3.4 Attaching Device



Make sure the mounting surface is strong enough to hold at least three times of the weight of the device and bracket.

Cable going through the mounting surface

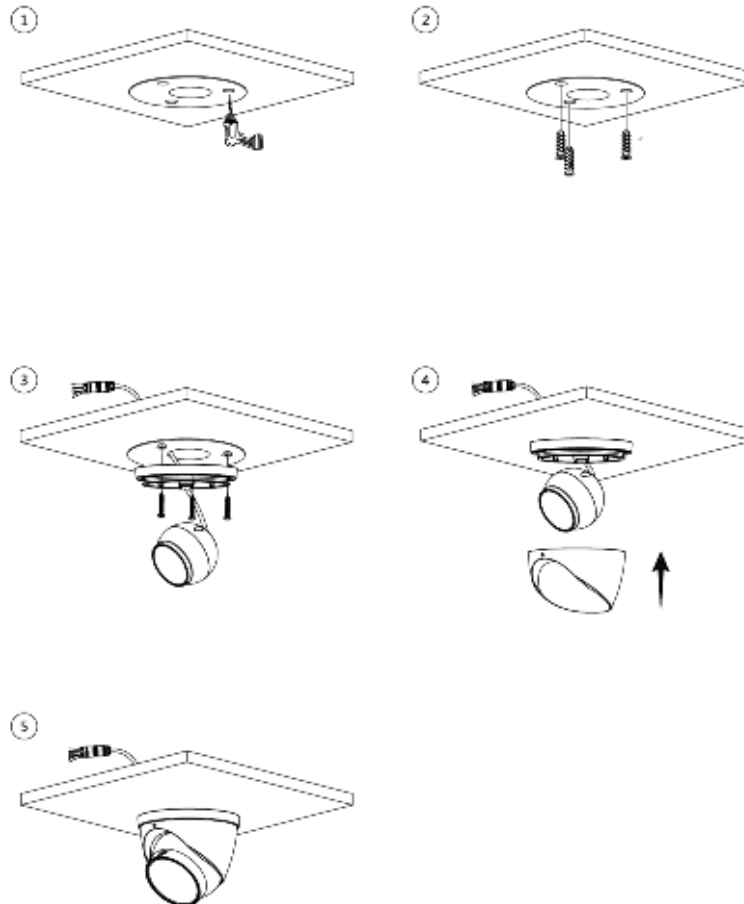

Cable going through the side cable tray

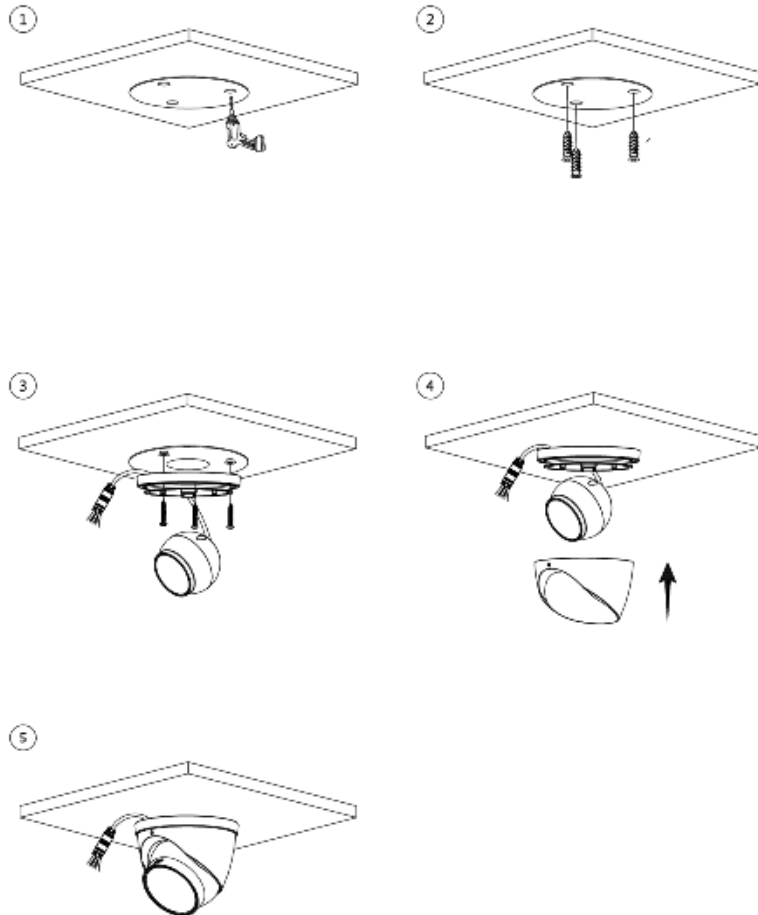

3.3.5 Installing Waterproof Connector (Optional)



This part is needed only when there is waterproof connector come with the device and the device is used outdoor.

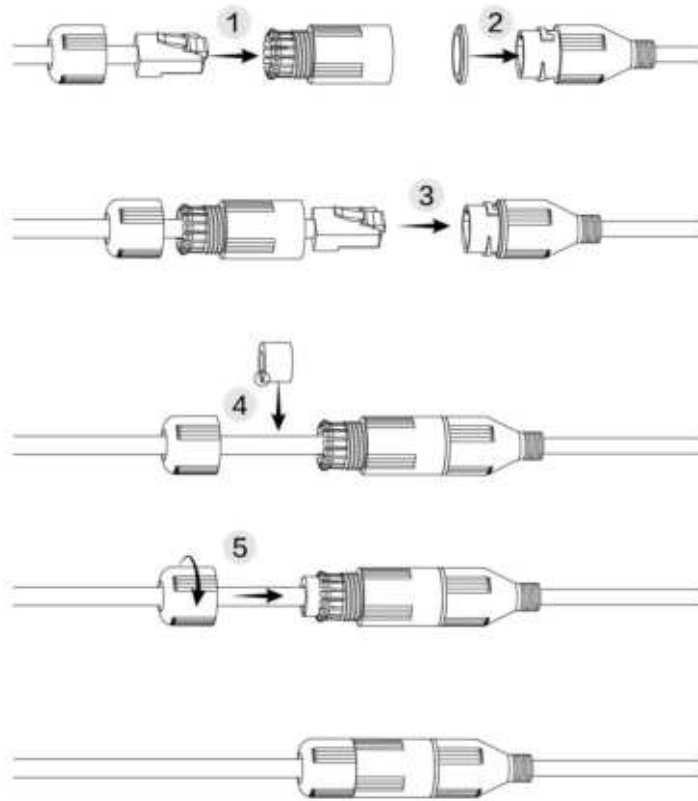

3.3.6 Adjusting Lens Angle

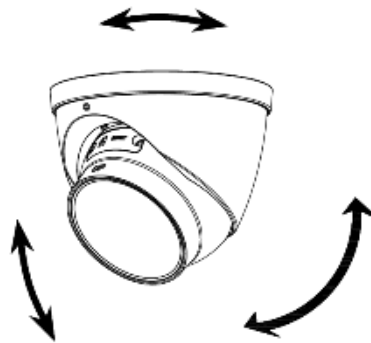

Manual





Foreword

General

This manual introduces the functions, configuration, general operation, and system maintenance of network camera.

Safety Instructions

The following categorized signal words with defined meaning might appear in the manual.

Signal Words	Meaning
 WARNING	Indicates a medium or low potential hazard which, if not avoided, could result in slight or moderate injury.
 CAUTION	Indicates a potential risk which, if not avoided, may result in property damage, data loss, lower performance, or unpredictable result.
 TIPS	Provides methods to help you solve a problem or save you time.
 NOTE	Provides additional information as the emphasis and supplement to the text.

Revision History

Version	Revision Content	Release Date
V2.0.2	<ol style="list-style-type: none">1. Modified the contents of "5.15 Setting ANPR."2. Added modeling in "5.11 Face Detection."	December 2019
V2.0.1	Added "5.5 Setting Smart Motion Detection."	August 2019
V2.0.0	<ol style="list-style-type: none">1. Consolidated the outline, and added baseline and safety contents, and some intelligent functions such as face recognition and ANPR.2. Deleted some old function such as stereo vision.	July 2019
V1.0.4	<ol style="list-style-type: none">1. Updated the chapters of "People Counting" and "Heat Map" function.2. Add VR mode of Fisheye device.3. Add video structuralization function.	March 2019
V1.0.3	Added Stereo Analysis function.	November 2018
V1.0.2	<ol style="list-style-type: none">1. Added chapters of "Initialization" and "Stereo vision."2. Updated the chapters of "Account", "Profile Management" and "SNMP."	October 2017
V1.0.1	First release.	September 2016

About the Manual

- The manual is for reference only. If there is inconsistency between the manual and the actual product, the actual product shall prevail.
- We are not liable for any loss caused by the operations that do not comply with the manual.
- The manual would be updated according to the latest laws and regulations of related regions. For detailed information, see the paper manual, CD-ROM, QR code or our official website. If there is inconsistency between paper manual and the electronic version, the electronic version shall prevail.
- All the designs and software are subject to change without prior written notice. The product updates might cause some differences between the actual product and the manual. Please contact the customer service for the latest program and supplementary documentation.
- There still might be deviation in technical data, functions and operations description, or errors in print. If there is any doubt or dispute, please refer to our final explanation.
- Upgrade the reader software or try other mainstream reader software if the manual (in PDF format) cannot be opened.
- All trademarks, registered trademarks and the company names in the manual are the properties of their respective owners.
- Please visit our website, contact the supplier or customer service if there is any problem occurred when using the device.
- If there is any uncertainty or controversy, please refer to our final explanation.

Important Safeguards and Warnings

Electrical Safety

- All installation and operation shall conform to your local electrical safety codes.
- The power source shall conform to the Safety Extra Low Voltage (SELV) standard, and supply power with rated voltage which conforms to Limited power Source requirement according to IEC60950-1. Note that the power supply requirement is subject to the device label.
- Make sure that the power supply is correct before operating the device.
- A readily accessible disconnecting device shall be incorporated in the building installation wiring.
- Prevent the power cable from being trampled or pressed, especially the plug, power socket and the junction extruded from the device.

Environment

- Do not aim the device at strong light to focus, such as lamp light and sun light; otherwise it might cause over brightness or light marks, which are not the device malfunction, and affect the longevity of Complementary Metal-Oxide Semiconductor (CMOS).
- Do not place the device in a damp, dusty extremely hot or cold environment, or the locations with strong electromagnetic radiation or unstable lighting.
- Keep the device away from any liquid to avoid damage to the internal components.
- Keep the indoor device away from rain or damp to avoid fire or lightning.
- Keep sound ventilation to avoid heat accumulation.
- Transport, use and store the device within the range of allowed humidity and temperature.
- Heavy stress, violent vibration or water splash are not allowed during transportation, storage and installation.
- Pack the device with standard factory packaging or the equivalent material when transporting the device.
- Install the device in the location where only the professional staff with relevant knowledge of safety guards and warnings can access. The accidental injury might happen to the non-professionals who enter the installation area when the device is operating normally.

Operation and Daily Maintenance

- Do not touch the heat dissipation component of the device to avoid scald.
- Carefully follow the instructions in the manual when performing any disassembly operation about the device; otherwise, it might cause water leakage or poor image quality due to unprofessional disassembly. Please contact after-sale service for desiccant replacement if there is condensed fog on the lens after unpacking or when the desiccant turns green. (Not all models are included with the desiccant).
- It is recommended to use the device together with lightning arrester to improve lightning protection effect.

- It is recommended to ground the device to enhance reliability.
- Do not touch the image sensor (CMOS) directly. Dust and dirt could be removed with air blower, or you can wipe the lens gently with soft cloth that is moistened with alcohol.
- You can clean the device body with soft dry cloth, and for stubborn stains, use the cloth with mild detergent. To avoid possible damage on device body coating which could cause performance decrease, do not use volatile solvent such as alcohol, benzene, diluent and so on to clean the device body, nor can strong, abrasive detergent be used.
- Dome cover is an optical component. Do not touch or wipe the cover with your hands directly during installation or operation. For removing dust, grease or fingerprints, wipe gently with moistened oil-free cotton with diethyl or moisten soft cloth. You can also remove dust with an air blower.

**WARNING**

- Strengthen the protection of network, device data and personal information by adopting measures which include but not limited to using strong password, modifying password regularly, upgrading firmware to the latest version, and isolating computer network. For some device with old firmware versions, the ONVIF password will not be modified automatically along with the modification of the system password, and you need to upgrade the firmware or manually update the ONVIF password.
- Use standard components or accessories provided by manufacturer and make sure that the device is installed and maintained by professional engineers.
- The surface of the image sensor should not be exposed to laser beam radiation in an environment where a laser beam device is used.
- Do not provide two or more power supply sources for the device unless otherwise specified. A failure to follow this instruction might cause damage to the device.

Table of Contents

Foreword	I
Important Safeguards and Warnings	III
1 Overview	1
1.1 Introduction	1
1.2 Network Connection.....	1
1.3 Function	1
1.3.1 Basic Function	1
1.3.2 Intelligent Function.....	2
2 Configuration Flow	5
3 Device Initialization	6
4 Basic Configuration	9
4.1 Login.....	9
4.2 Live.....	10
4.2.1 Live Interface	10
4.2.2 Encode bar	11
4.2.3 Live View Function Bar.....	11
4.2.4 Window Adjustment Bar	13
4.3 PTZ Operation.....	20
4.3.1 Configuring External PTZ Protocol.....	20
4.3.2 Configuring PTZ Function.....	21
4.3.3 Calling PTZ	32
4.4 Playback.....	35
4.4.1 Playback Interface	35
4.4.2 Playing back Video or Picture.....	38
4.4.3 Clipping Video.....	40
4.4.4 Downloading Video or Picture	41
4.5 Camera.....	42
4.5.1 Conditions	42
4.5.2 Setting Video Parameters.....	55
4.5.3 Audio	70
4.6 Network	72
4.6.1 TCP/IP	73
4.6.2 Port	75
4.6.3 PPPoE	76
4.6.4 DDNS.....	77
4.6.5 SMTP (Email).....	78
4.6.6 UPnP.....	80
4.6.7 SNMP.....	81
4.6.8 Bonjour.....	83
4.6.9 Multicast.....	84
4.6.10 802.1x	85
4.6.11 QoS	85

4.6.12 Access Platform	86
4.7 Storage	88
4.7.1 Setting Storage Plan	88
4.7.2 Setting Schedule	89
4.7.3 Setting Destination	90
4.8 System	93
4.8.1 General	93
4.8.2 Date & Time	94
4.8.3 Splicing	95
4.8.4 Account	96
4.8.5 Safety	102
4.8.6 Peripheral	109
5 Event	113
5.1 Setting Alarm Linkage	113
5.1.1 Alarm Linkage	113
5.1.2 Subscribing Alarm	120
5.2 Setting Smart Track	122
5.2.1 Setting Calibration Parameters for Smart Track	122
5.2.2 Enabling Alarm Track	123
5.3 Setting Panoramic Calibration	124
5.4 Setting Video Detection	126
5.4.1 Setting Motion Detection	126
5.4.2 Setting Video Tamper	128
5.4.3 Setting Scene Changing	129
5.5 Setting Smart Motion Detection	129
5.6 Setting Audio Detection	130
5.7 Setting Smart Plan	132
5.8 Setting IVS	132
5.8.1 Global Configuration	133
5.8.2 Rule Configuration	135
5.9 Setting Crowd Map	139
5.9.1 Global Configuration	139
5.9.2 Rule Configuration	140
5.10 Setting Face Recognition	143
5.10.1 Setting Face Detection	143
5.10.2 Setting Face Database	145
5.10.3 Setting Face Recognition Alarm Linkage	155
5.10.4 Viewing Face Recognition Result	155
5.11 Setting Face Detection	158
5.12 Setting People Counting	160
5.12.1 People Counting	160
5.12.2 Queuing	164
5.12.3 Viewing People Counting Diagram	166
5.12.4 Viewing People Counting Report	168
5.13 Setting Heat Map	169
5.13.1 Heat Map	169

5.13.2 Viewing Heat Map Report.....	170
5.14 Setting Stereo Analysis.....	171
5.14.1 Setting Rules for Stereo Analysis.....	171
5.14.2 Calibration Configuration.....	174
5.15 Setting ANPR.....	175
5.15.1 Scene Configuration.....	175
5.15.2 Setting Picture Overlay.....	176
5.15.3 Viewing ANPR Report.....	177
5.16 Setting Video Structuralization.....	178
5.16.1 Scene Configuration.....	178
5.16.2 Setting Picture Information.....	181
5.16.3 Viewing Video Structuralization Report.....	182
5.17 Setting Relay-in.....	182
5.18 Setting Abnormality.....	183
5.18.1 Setting SD Card.....	183
5.18.2 Setting Network.....	184
5.18.3 Setting Illegal Access.....	185
5.18.4 Setting Voltage Detection.....	185
5.18.5 Setting Security Exception.....	186
6 Maintenance.....	187
6.1 Requirements.....	187
6.2 Auto Maintain.....	187
6.3 Resetting Password.....	188
6.4 Backup and Default.....	190
6.4.1 Import/Export.....	190
6.4.2 Default.....	191
6.5 Upgrade.....	191
6.6 Information.....	192
6.6.1 Version.....	192
6.6.2 Log.....	192
6.6.3 Remote Log.....	194
6.6.4 Online User.....	194
Appendix 1 Cybersecurity Recommendations.....	196

1 Overview

1.1 Introduction

IP camera (Internet Protocol camera), is a type of digital video camera that receives control data and sends image data through internet. They are commonly used for surveillance, requiring no local recording device, but only a local area network.

IP camera is divided into single-channel camera and multi-channel camera according to the channel quantity. For multi-channel camera, you can set the parameters for each channel.

1.2 Network Connection

In the general IPC network topology, IPC is connected to PC through network switch or router. See Figure 1-1.

Figure 1-1 General IPC network

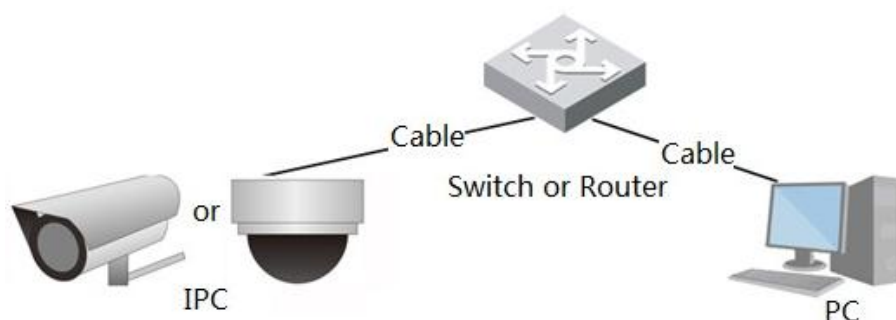

Get IP address by searching on ConfigTool, and then you can start accessing IPC through network.

1.3 Function

Functions might vary with different devices, and the actual product shall prevail.

1.3.1 Basic Function

Real-time Monitoring

- Live view.
- When live viewing the image, you can enable audio, voice talk and connect monitoring center for quick processing on the abnormality.
- Adjust the image to the proper position by PTZ.
- Snapshot and triple snapshot abnormality of the monitoring image for subsequent view and processing.

- Record abnormality of monitoring image for subsequent view and processing.
- Configure coding parameters, and adjust live view image.

Record

- Auto record as schedule.
- Play back recorded video and picture as needed..
- Download recorded video and picture.
- Alarm linked recording.

Account

- Add, modify and delete user group, and manage user authorities according to user group.
- Add, modify and delete user, and configure user authorities.
- Modify user password.

1.3.2 Intelligent Function

Alarm

- Set alarm prompt mode and tone according to alarm type.
- View alarm prompt message.

Smart Track

- Set calibration and parameters for smart track and enable alarm track.
- Switch between smart track and speed dome auto track.

Video Detection

- Motion detection, video tampering detection and scene changing detection.
- When an alarm is triggered, the system performs linkages such as recording, alarm output, sending email, PTZ operation, and snapshot.

Smart Motion Detection

- Avoid the alarms triggered by the environment changes.
- When an alarm is triggered, the system performs linkages such as recording, alarm output, sending email, PTZ operation, and snapshot.

Audio Detection

- Audio input abnormal detection and intensity change detection.
- When an alarm is triggered, the system performs linkages such as recording, alarm output, sending email, PTZ operation, and snapshot.

IVS

- Tripwire, intrusion, abandoned object, moving object, fast moving, parking detection, people gathering, and loitering detection.
- When an alarm is triggered, the system performs linkages such as recording, alarm output, sending email, PTZ operation, and snapshot.

Crowd Map

- View crowd distribution in real time for the timely arm to avoid accidents like stampede.
- When an alarm is triggered, the system performs linkages such as recording, alarm output, sending email, PTZ operation, and snapshot.

Face Detection

- Detect face and display the related attributes on the live interface.
- When an alarm is triggered, the system performs linkages such as recording, alarm output, sending email, PTZ operation, and snapshot.

Face Recognition

- After detecting face, make comparison between the detected face with the face in face database, and activates alarm output.
- Query the recognition result.

People Counting

- Count the people flow in/out the detection area, and generate report.
- When an alarm is triggered, the system performs linkages such as recording, alarm output, sending email, PTZ operation, and snapshot.

Heat Map

- Count cumulative density of moving objects.
- View report of heat map.

Stereo Analysis

- Include fall detection, violence detection, people No. error, people approaching detection, and stay detection.
- When an alarm is triggered, the system performs linkages such as recording, alarm output, sending email, PTZ operation, and snapshot.

ANPR

- Recognize plate number in detection area, and display the related information on live interface.
- When an alarm is triggered, the system links alarm output and snapshot.

Video Structuralization

- Snap people, non-motor vehicle and vehicle, and display the related information on the live interface.
- When an alarm is triggered, the system links alarm output.

Alarm Setting

- The alarm is triggered when an external alarm input device inputs alarm.
- When an alarm is triggered, the system performs linkages such as recording, alarm output, sending email, PTZ operation, and snapshot.

Abnormality

- SD card error, network disconnection, illegal access, voltage detection and security exception.
- When SD card error or illegal access is triggered, the system links alarm output and sending email.
- When network disconnection alarm is triggered, the system links recording and alarm output.
- When the input voltage is more or less than the rated voltage, the alarm is triggered and the system links sending email.

2 Configuration Flow

For the device configuration flow, see Figure 2-1. For details, see Table 2-1. Configure the device according to the actual situation.

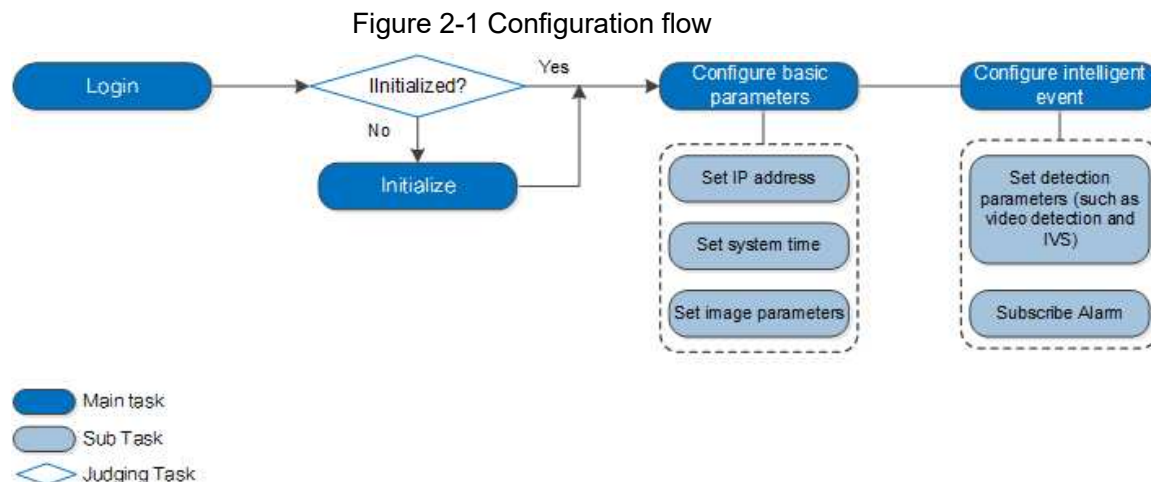

Table 2-1 Description of flow

Configuration		Description	Reference
Login		Open IE browser and enter IP address to log in to the web interface, The camera IP address is 192.168.1.108 by default.	4.1 Login
Initialization		Initialize the camera when you use it for the first time.	3 Device Initialization
Basic parameters	IP address	Modify IP address according to network planning for the first use or during network adjustment.	4.6.1 TCP/IP
	Date & time	Set date and time to ensure the recording time is correct.	4.8.2 Date & Time
	Image parameters	Adjust image parameters according to the actual situation to ensure the image quality.	4.5.1 Conditions
Intelligent Event	Detection rules	Configure the necessary detection rules, such as video detection and IVS.	5 Event
	Subscribe alarm	Subscribe alarm event. When the subscribed alarm is triggered, the system will record the alarm on the alarm tab.	5.1.2 Subscribing Alarm

3 Device Initialization

Device initialization is required for the first use. This manual is based on the operation on the web interface. You can also initialize device through ConfigTool, NVR, or platform devices.



- To ensure the device safety, keep the password properly after initialization and change the password regularly.
- When initializing device, keep the PC IP and device IP in the same network.

Step 1 Open IE browser, enter the IP address of the device in the address bar, and then press Enter.

The **Device Initialization** interface is displayed. See Figure 3-1.



The IP is 192.168.1.108 by default.

Figure 3-1 Device initialization

The screenshot shows the 'Device Initialization' web interface. It contains the following elements:

- Username:** A text input field containing 'admin'.
- Password:** A text input field with a red error message: 'The minimum pass phrase length is 8 characters'. Below it are three buttons: 'Weak', 'Middle', and 'Strong'.
- Confirm Password:** A text input field.
- Email Address:** A text input field with a checked checkbox and the label 'Email Address'.
- Save:** A button at the bottom center.
- Security Notice:** A paragraph of text: 'Use a password that has 8 to 32 characters. It can be a combination of letter(s), number(s) and symbol(s) with at least two kinds of them (please do not use special symbols like * , ; &)'.
- Reset Note:** A note at the bottom: 'To reset password, please input properly or update in time.'

Step 2 Set the password for admin account. For details, see Table 3-1.

Table 3-1 Description of password configuration

Parameter	Description
User name	The default user name is admin.
Password	The password must consist of 8 to 32 non-blank characters and contain at least two types of characters among upper case, lower case, number, and special character (excluding ' " ; : &). Set a high security level password according to the password security notice.
Confirm password	
email	Enter an email address for password reset, and it is selected by default. When you need to reset the password of the admin account, a security code for password resetting will be sent to the reserved email address.

Step 3 Click **Save**.

The **End-User License Agreement** interface is displayed. See Figure 3-2.

Figure 3-2 End-user license agreement

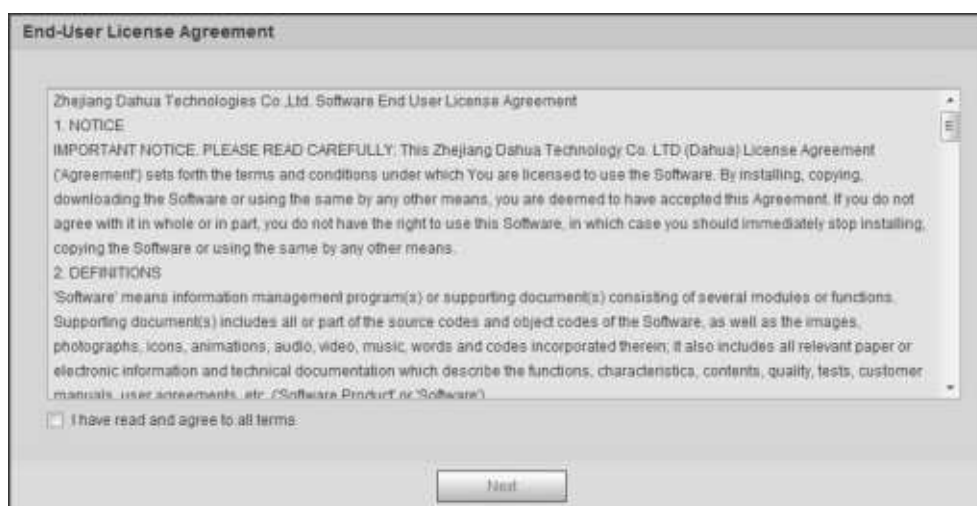

Step 4 Select the **I have read and agree to all terms** check box, and then click **Next**. The **Easy4ip** interface is displayed. See Figure 3-3.

Figure 3-3 Easy4ip



Step 5 You can register the camera to Easy4ip, select the check box as needed, and then click **Next**.

The **Online Upgrade** interface is displayed. See Figure 3-4.

Figure 3-4 Online upgrade

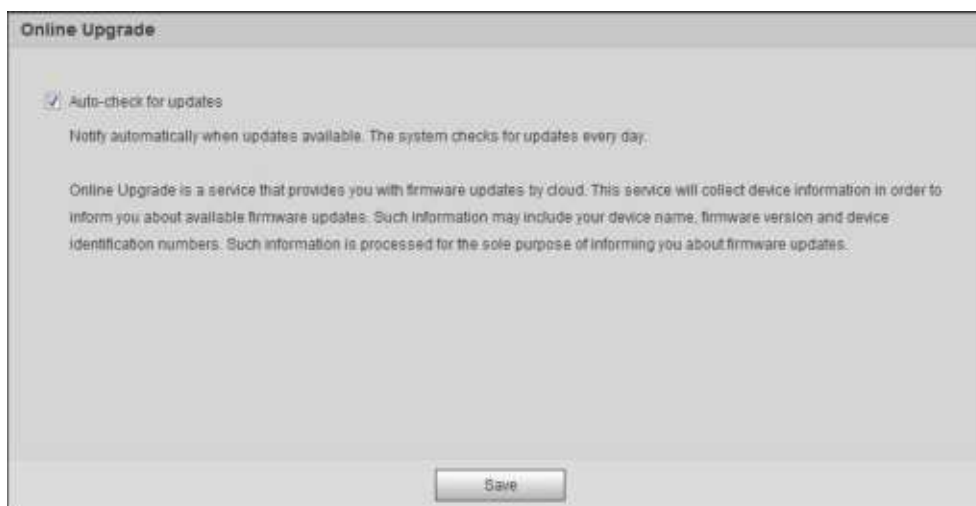

Step 6 Select the upgrading method as needed.

If you select **Auto-check for updates**, the system checks new version once a day automatically. There will be system notice on **Upgrade** interface and **Version** interface if any new version is available.



Select **Setting > System > Upgrade > Online Upgrade**, and you can enable the auto-check function.

Step 7 Click **Save**.

Device initialization is completed.

4 Basic Configuration

The chapter introduces the basic configuration, including login, live view, PTZ operation, playback operation, camera configuration, network configuration, storage configuration and system configuration.

4.1 Login

This section introduces how to log in to and log out of the web interface. This section takes IE Explorer 9 as an example.



- You need to initialize the camera before logging in to the web interface. For details, see "3 Device Initialization."
- When initializing the camera, keep the PC IP and device IP in the same network.
- Follow the instruction to download and install the plug-in for the first login.

Step 1 Open IE browser, enter the IP address of the camera (192.168.1.108 by default) in the address bar and press Enter.

The login interface is displayed. See Figure 4-1.

Figure 4-1 Login

Step 2 Enter the username and password.

The username is admin by default.



Click **Forgot password?**, and you can reset the password through the email address that is set during the initialization. For details, see "6.3 Resetting Password."

Step 3 Click **Login**.

The **Live** interface is displayed, see Figure 4-2.

- **Live**: Click **Live**, and you can view the real-time monitoring image.
- **Playback**: Click **Playback**, and you can play back or download recorded video or image files.

- **Setting**: Click **Setting**, and you can configure the basic and intelligent functions of the camera.
For the camera with multiple channels, through selecting channel numbers, you can set the parameters of the channels.
- **Alarm**: Click **Alarm**, and you can subscribe and view alarm information.
- **Logout**: Click **Logout** to go to login interface.
The system will sleep automatically after idling for a period of time.

Figure 4-2 Live



4.2 Live

This section introduces the layout of the interface and function configuration.

4.2.1 Live Interface

This section introduces system menu, encode bar, live view function bar, and window adjustment bar.

Log in and click the **Live** tab, and the **Live** interface is displayed. See Figure 4-3. For the layout details, see Table 4-1.



The functions and interfaces of different models might vary, and the actual product shall prevail.

Figure 4-3 Live



Table 4-1 Description of function bar

No.	Function	Description
1	Encode bar	Sets stream type and protocol.
2	Live view	Displays the real-time monitoring image.
3	Live view function bar	Functions and operations in live viewing.
4	Window adjustment bar	Adjustment operations in live viewing.

4.2.2 Encode bar

For encode bar, see Figure 4-4.

Figure 4-4 Encode bar

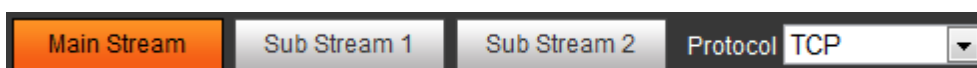

- **Main Stream:** It has large bit stream value and image with high resolution, but also requires large bandwidth. This option can be used for storage and monitoring. For details, see "4.5.2.1 Video."
- **Sub Stream:** It has small bit stream value and smooth image, and requires less bandwidth. This option is normally used to replace main stream when bandwidth is not enough. For details, see "4.5.2.1 Video."
- **Protocol:** You can select the network transmission protocol as needed, and the options are **TCP**, **UDP** and **Multicast**.























Before selecting **Multicast**, make sure that you have set the **Multicast** parameters.

4.2.3 Live View Function Bar

For the live view function bar, see Table 4-2.

Table 4-2 Description of live view function bar

Icon	Function	Description
	Manual Position	<p>Manually position the tracking speed dome to the selected location of corresponding panoramic camera.</p> <p>Click the icon and click or select randomly on the image of panoramic camera channel, the tracking speed dome will automatically position the selected location.</p> <p></p> <ul style="list-style-type: none"> For multi-sensor panoramic network camera + PTZ camera, before enabling manual position, make sure that you have enabled alarm track and smart track calibration. For details, see "5.2 Setting Smart Track." For panoramic network camera, before enabling manual position, make sure that you have enabled panoramic linkage. For details, see "5.3 Setting Panoramic Calibration."
	Regional Focus	<p>Select channel image of the tracking speed dome, click the icon and click or select randomly on the channel image of the tracking speed dome, and then the speed dome can realize auto focus upon the selected region.</p>
	Wiper	<p>Controls the wiper of the camera.</p> <p>Click the icon to enable or disable wiper function.</p>
	Ranging	<p>Click the icon, select a point on the ground, and the distance between the camera and the selected point will be displayed.</p> <p></p> <p>Before using this function, you need to set the installation of device first. For details, see "4.5.2.3.11Configuring Ranging."</p>
	Gesture	<p>Controls PTZ by operating the mouse on the live view of tracking speed dome.</p> <p>Select the live view of tracking speed dome, click the icon, press left-button and drag image to control PTZ. And you can zoom the image through rolling mouse wheel.</p>
	Manual Track	<p>Click the icon, and select tracking target on the live view of tracking speed dome, the camera tracks the selected target automatically.</p>
	Relay-out	<p>Displays alarm output state. Click the icon to force to enable or disable alarm output.</p> <p>Alarm output state description:</p> <ul style="list-style-type: none"> Red: Alarm output enabled. Grey: Alarm output disabled.
	Digital Zoom	<p>You can zoom video image through two operations.</p> <ul style="list-style-type: none"> Click the icon, and then select an area in the video











Icon	Function	Description
		<p>image to zoom in; right-click on the image to resume the original size. In zoom in state, drag the image to check other area.</p> <ul style="list-style-type: none"> Click the icon, and then scroll the mouse wheel in the video image to zoom in or out.
	Snapshot	<p>Click the icon to capture one picture of the current image, and it will be saved to the configured storage path.</p> <p></p> <p>About viewing or configuring storage path, see "4.5.2.5 Path."</p>
	Triple Snapshot	<p>Click the icon to capture three pictures of the current image, and they will be saved to the configured storage path.</p> <p></p> <p>About viewing or configuring storage path, see "4.5.2.5 Path."</p>
	Record	<p>Click the icon to record video, and it will be saved to the configured storage path.</p> <p></p> <p>About viewing or configuring storage path, see "4.5.2.5 Path."</p>
	Easy Focus	<p>Click the icon, the AF Peak (focus eigenvalue) and AF Max (max focus eigenvalue) are displayed on the video image.</p> <ul style="list-style-type: none"> AF Peak: The eigenvalue of image definition, it displays during focus. AF Max: The best eigenvalue of image definition. The smaller the difference between AF peak value and the AF max value, the better the focus is. <p></p> <p>Easy focus closes automatically after five minutes.</p>
	Audio	Click the icon to enable or disable audio output.
	Talk	Click the icon to enable or disable the audio take.









4.2.4 Window Adjustment Bar

4.2.4.1 Adjustment

This section introduces the adjustment of image. For details, see Table 4-3.

Table 4-3 Description of adjustment bar

Icon	Function	Description
	Image Adjustment	<p>Click the icon, and then the Image Adjustment interface is displayed at the right side of the Live interface. You can adjust brightness, contrast, hue, and saturation.</p> <p></p> <p>The adjustment is only available on the web interface, and it does not adjust the camera parameters.</p> <ul style="list-style-type: none">  (Brightness adjustment): Adjusts the overall image brightness, and changes the value when the image is too bright or too dark. The bright and dark areas will have equal changes.  (Contrast adjustment): Changes the value when the image brightness is proper but contrast is not enough  (Hue adjustment): Makes the color deeper or lighter. The default value is made by the light sensor, and it is recommended.  (Saturation adjustment): Adjusts the image saturation, this value does not change image brightness.
	Original Size	Click the icon, and then the video displays with original size.
	Full Screen	Click the icon to enter full screen mode; double-click or press Esc to exit.
	W:H	Click the icon to resume original ratio or change ratio.
	Fluency	<p>Click the icon to select the fluency from Realtime, Fluency and Normal.</p> <ul style="list-style-type: none"> Realtime: Guarantees the real time of the image. When the bandwidth is not enough, the image might not be smooth. Fluency: Guarantees the fluency of the image. There might be delay between live view image and real-time image. Normal: It is between Realtime and Fluency.
	Rule Info	Click the icon, and then select Enable to display smart rules and detection box; select Disable to stop the display. It is enabled by default.

Icon	Function	Description
	PTZ	Click the icon, and the PTZ control panel is displayed at the right side of the Live interface. You can control and call PTZ function. For details, see "4.3.3 Calling PTZ."
	Zoom and Focus	Adjust focal length to zoom in and out video image. Click the icon, and the Zoom and Focus configuration interface is displayed at the right side of the Live interface. You can control and call PTZ function. For details, see "4.2.4.2 Zoom and Focus."
	Fisheye	Click the icon, and then the fisheye configuration interface is displayed at the right side of the Live interface. For details, see "4.2.4.3 Fisheye."
	Face	Click the icon, and the face detection or face recognition results are displayed on the Live interface. <ul style="list-style-type: none"> • For face recognition, see "5.10 Setting Face Recognition." • For face detection: see "5.11 Setting Face Detection."
	ANPR	Click the icon, and the ANPR results are displayed on the Live interface. For details, see "5.15 Setting ANPR."
	Video Structuralization	Click the icon, the video structuralization results are displayed on the Live interface. For details, see "5.16 Setting Video Structuralization."
	Window Layout	When view multi-channel image, you can select display layout.
	Crowd Map	Click the icon and select the Enable check box. The Crowd Map interface is displayed. For details, see "5.9 Setting Crowd Map."

4.2.4.2 Zoom and Focus

You can adjust focal length to zoom in or out video image; by adjusting focus manually, automatically or within a certain area, you can change image clarity or correct adjusting errors.



The focus would adjust automatically after zooming in or out.

Figure 4-5 Zoom and focus

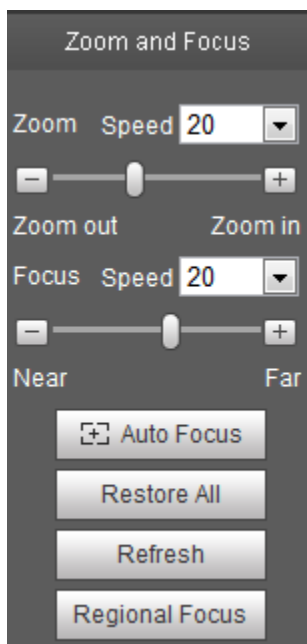



Table 4-4 Description of zoom and focus

Parameter	Description
Zoom	<p>Changes the focal length of the camera to zoom in or out the image.</p> <ol style="list-style-type: none"> 1. Set the Speed value. The Speed is the adjustment range in one click. The larger the value is, the more the image would zoom in or out in one click. 2. Click or hold + /- button, or drag the slider to adjust zoom.
Focus	<p>Adjusts the optical back focal length to make the image clearer.</p> <ol style="list-style-type: none"> 1. Set the Speed value. The Speed is the adjustment range in one click. The larger the value is, the more the image would zoom in or out in one click. 2. Click or hold + /- button, or drag the slider to adjust zoom.
Auto Focus	<p>Adjusts image clarity automatically.</p>  <p>Do not make any other operation during auto focus process.</p>
Restore All	<p>Restores focus to default value and corrects errors.</p>  <p>You can restore the focus if the image has poor clarity or has been zoomed too frequently.</p>
Regional Focus	<p>Focus on the subject of a selected area.</p> <p>Click Regional Focus, and then select an area in the image, the camera performs auto focus in that area.</p>
Refresh	<p>Get the latest zoom setting of the device.</p>

4.2.4.3 Fisheye

You can select the installation mode, display mode and VR mode of fisheye devices as needed. For details, see Table 4-5.







- **Install Mode:** Select the installation mode according to the actual situation.
- **Display Mode:** Select the display mode of live view.
- **VR Mode:** Select VR mode to display images in stereo mode.







Figure 4-6 Fisheye





Table 4-5 Description of fisheye configuration

Parameter	Description
Installation mode	Includes ceiling mount, wall mount, and ground mount.
Display mode	<p>The display model of the current image. There are different display modes for each installation mode.</p> <ul style="list-style-type: none"> • Ceiling: 1P+1, 2P, 1+2, 1+3, 1+4, 1P+6, 1+8. • Wall: 1P, 1P+3, 1P+4, 1P+8. • Ground: 1P+1, 2P, 1+3, 1+4, 1P+6, 1+8. <p></p> <p>The image will be on original size by default when switching installation mode.</p>

Parameter	Description	
Ceiling/Wall/Ground mount	 Original image	The original image before correction.
Ceiling/Ground mount	 1P+1	360° rectangular panoramic image screen + independent sub-screens. <ul style="list-style-type: none"> You can zoom or drag the image in all the screens. You can move the start point (left and right) on rectangular panoramic image screen.
	 2P	Two associated 180° rectangular image screens, and at any time, the two screens form a 360° panoramic image. It is also called dual-panoramic image. You can move the start point (left and right) on the two rectangular panoramic image screens, and the two screens link each other.
	 1+2	Original image screen + two independent sub-screens. Ground Mount does not support this display mode. <ul style="list-style-type: none"> You can zoom or drag the image in all the screens. You can rotate the image on the original image screen to change the start point.
	 1+3	Original image screen + three independent sub-screens. <ul style="list-style-type: none"> You can zoom or drag the image in all the screens. You can rotate the image on the original image screen to change the start point.
	 1+4	Original image screen + four independent sub-screens. <ul style="list-style-type: none"> You can zoom or drag the image in all the screens. You can rotate the image on the original image screen to change the start point.
	 1P+6	360° rectangular panoramic screen + six independent sub-screens. <ul style="list-style-type: none"> You can zoom or drag the image in all the screens. You can move the start point (left and right) on rectangular panoramic image screen.

Parameter	Description
	 1P+8 Original image screen + eight independent sub-screens. <ul style="list-style-type: none"> You can zoom or drag the image in all the screens. You can rotate the image on the original image screen to change the start point.
Wall mount	 1P 180° rectangular panoramic image screen (from left to right). You can drag the image in all the screens (up and down) to adjust the vertical view.
	 1P+3 180° rectangular panoramic image screen + three independent sub-screens. <ul style="list-style-type: none"> You can zoom or drag the image in all the screens. You can drag the image in all the screens (upper and lower) to adjust the vertical view.
	 1P+4 180° rectangular panoramic image screen + four independent sub-screens. <ul style="list-style-type: none"> You can zoom or drag the image in all the screens. You can drag the image in all the screens (upper and lower) to adjust the vertical view.
	 1P+8 180° rectangular panoramic image screen + eight independent sub-screens. <ul style="list-style-type: none"> You can zoom or drag the image in all the screens. You can drag the image in all the screens (upper and lower) to adjust the vertical view.
VR mode	 Panorama Drag or cross the screen 360° to unfold the distortion panorama, and you can drag the image in left/right direction.
	 Semi-circle <ul style="list-style-type: none"> You can drag the image in upper/lower/left/right direction. Press I to display the panorama, and press O to resume the original size. Press S to rotate the image in anticlockwise direction, and press E to stop the rotation. Scroll the mouse wheel to zoom the image.

Parameter	Description	
	 Cylinder	Display the distortion panorama in 360° circularity. <ul style="list-style-type: none"> You can drag the image in upper/lower/left/right direction. Press I to display the panorama, and press O to return to the original size. Press S to rotate the image in anticlockwise direction, and press E to stop the rotation. Scroll the mouse wheel to zoom the image.
	 Asteroid	<ul style="list-style-type: none"> You can drag the image in upper/lower/left/right direction. Press I to display the panorama, and press O to return to the original size. Press the left mouse-button to slide down to display the image on the plane surface. Scroll the mouse wheel to zoom the image.

4.3 PTZ Operation

This section introduces PTZ parameter configuration, PTZ control and PTZ function configuration.

4.3.1 Configuring External PTZ Protocol

You need to configure PTZ protocol when accessing external PTZ; otherwise the camera cannot control external PTZ.

Preparation

- Access external PTZ through RS-485.
- You have configured the parameters of serial port. For details, see "4.8.6.1 Serial Port Settings."

Procedure

Step 1 Select **Setting > PTZ Setting > Protocol**.

The **PTZ Setting** interface is displayed. See Figure 4-7.

Figure 4-7 PTZ setting

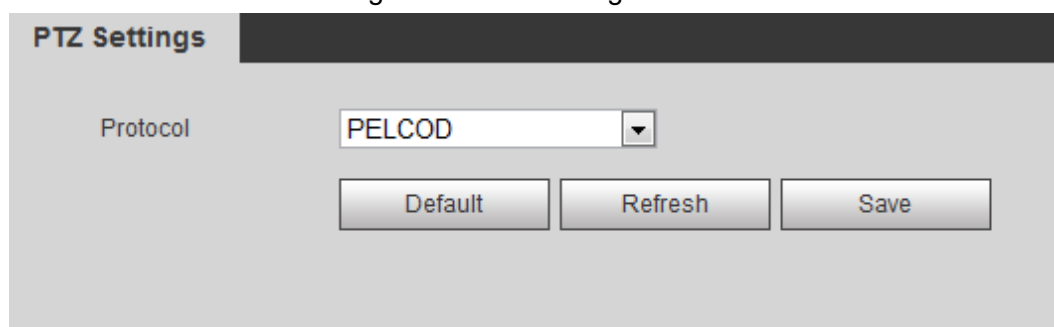

Step 2 Select the PTZ protocol.

Step 3 Click **OK**.

4.3.2 Configuring PTZ Function

4.3.2.1 Preset



Preset means a certain position that the camera can make quick orientation to. It includes PTZ pan and tilt angles, camera focus, and location.

Step 1 Select **Setting > PTZ settings > Function > Preset**.

The **Preset** interface is displayed. See Figure 4-8.

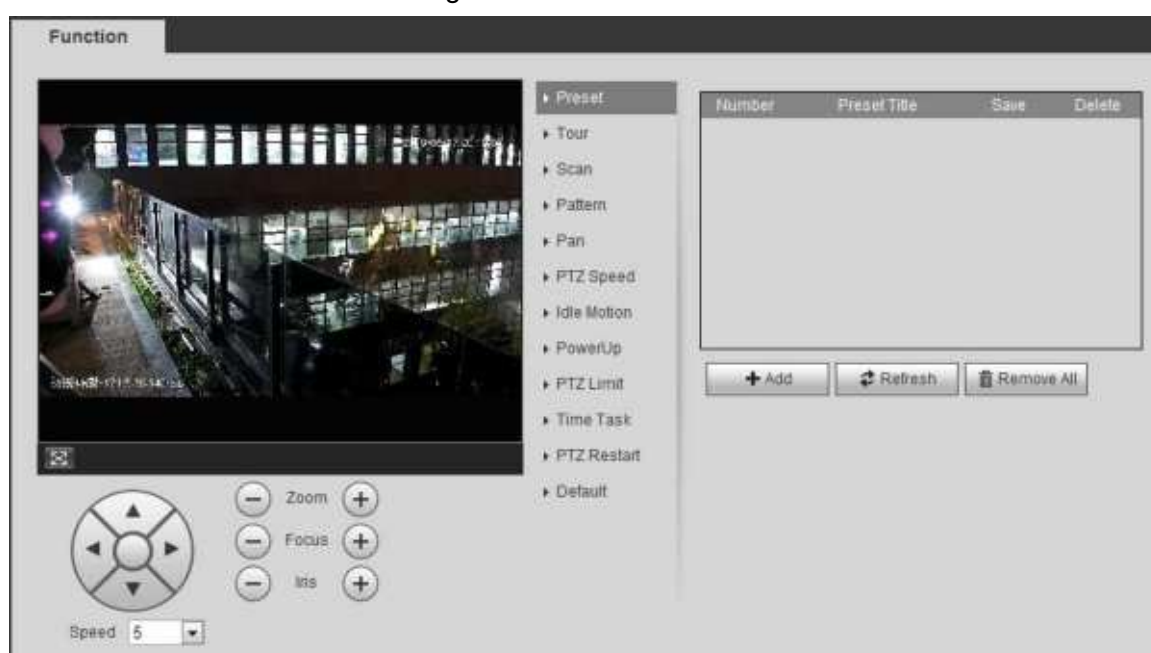
Figure 4-8 Preset



Step 2 Set the speed, and click ,  and  to adjust the parameters of direction, zoom, focus and iris, to move the camera to the position you need.

Step 3 Click **Add** to add the current position to be a preset, and the preset is displayed in preset list.

Step 4 Double-click the preset title to edit it.

Step 5 Click  to save the preset.

Other Operations

- Click  to delete the preset.
- Click **Remove All** to remove all presets.

4.3.2.2 Tour

Tour means a series of movements that the camera makes along several presets.

Preparation

You have set several presets.

Procedure

Step 1 Select **Setting > PTZ settings > Function > Tour**.

The **Tour** interface is displayed. See Figure 4-9.

Figure 4-9 Tour

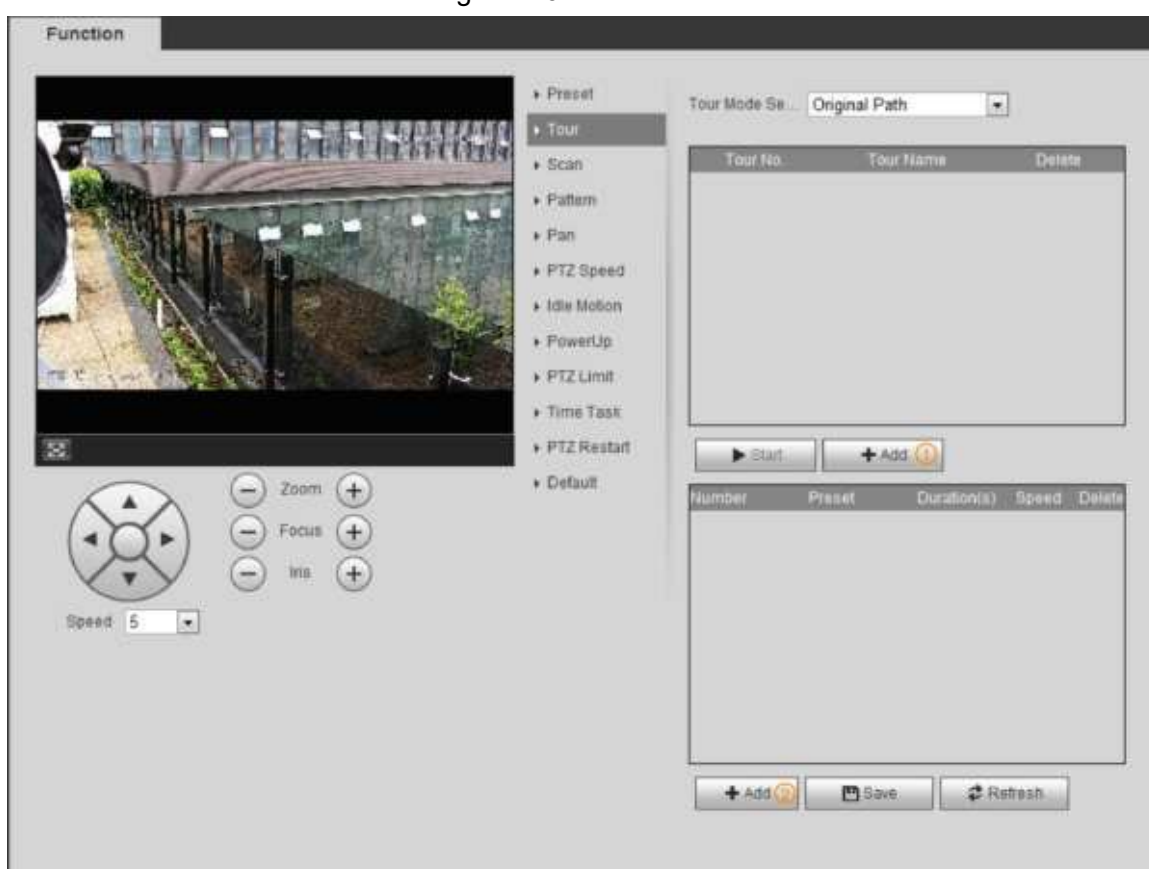

Step 2 Click **Add** ① to add tour.

Double-click the tour name to edit the name.

Step 3 Click **Add** ② to add preset.

Double-click the duration to set the duration.

Step 4 Select the tour mode.

- Original path: The PTZ camera moves in the order of the selected presets.
- Shortest path: The PTZ camera ranks presets by distance, and moves in the optimal path.

Step 5 Click **Save**.

Step 6 Click **Start** to start touring.



- If you operate PTZ during tour, the camera will stop tour.
- Click **Stop** to stop touring.

4.3.2.3 Scan

Scan means the camera moves horizontally at a certain speed between the configured left and right limits.

Step 1 Select **Setting > PTZ settings > Function > Scan**.

The **Scan** interface is displayed. See Figure 4-10.

Figure 4-10 Scan

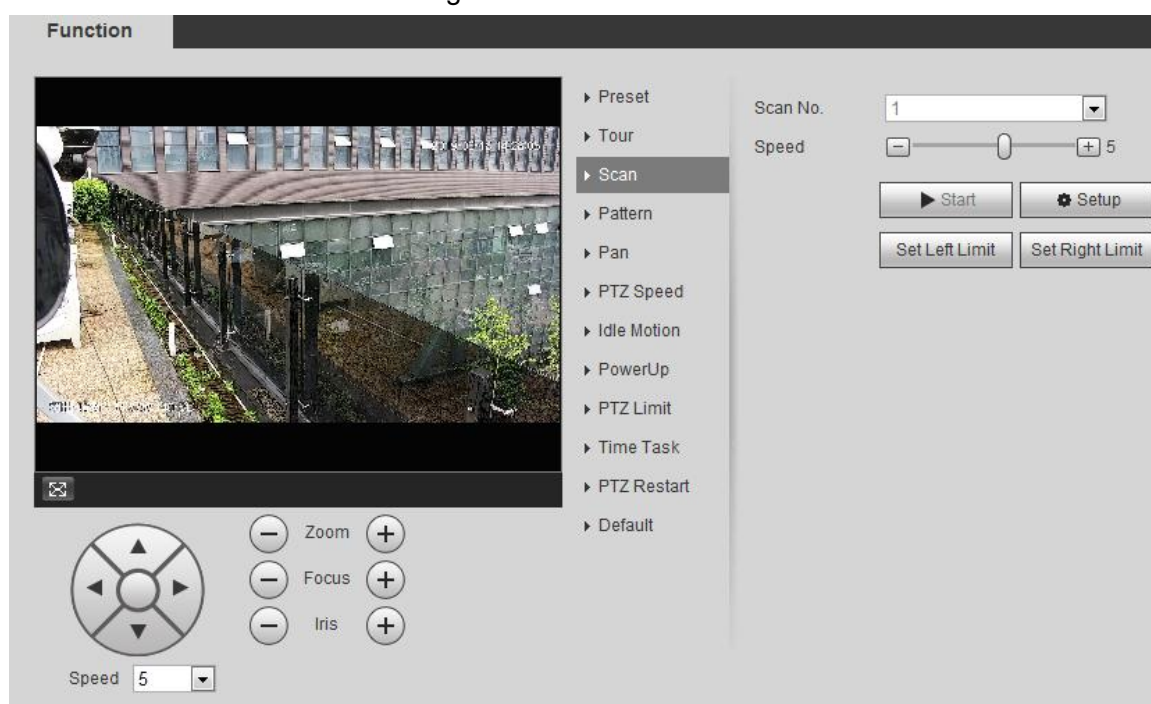

Step 2 Select the scan number, and set the speed.

Step 3 Click **Setup** to set left limit and right limit.

- 1) Click **Set Left Limit** to set the current position to be the left limit.
- 2) Click **Set Right Limit** to set the current position to be the right limit.

Step 4 Click **Start** to start scanning.

Click **Stop** to stop scanning.

4.3.2.4 Pattern

Pattern means a recording of a series of operations that you make to the camera, and when pattern starts, the camera performs the operations repeatedly. The operations include horizontal and vertical movements, zoom and preset calling. Record and save the operations, and then you can call the pattern path directly.

Step 1 Select **Setting > PTZ settings > Function > Pattern**.

The **Pattern** interface is displayed. See Figure 4-11.

Figure 4-11 Pattern

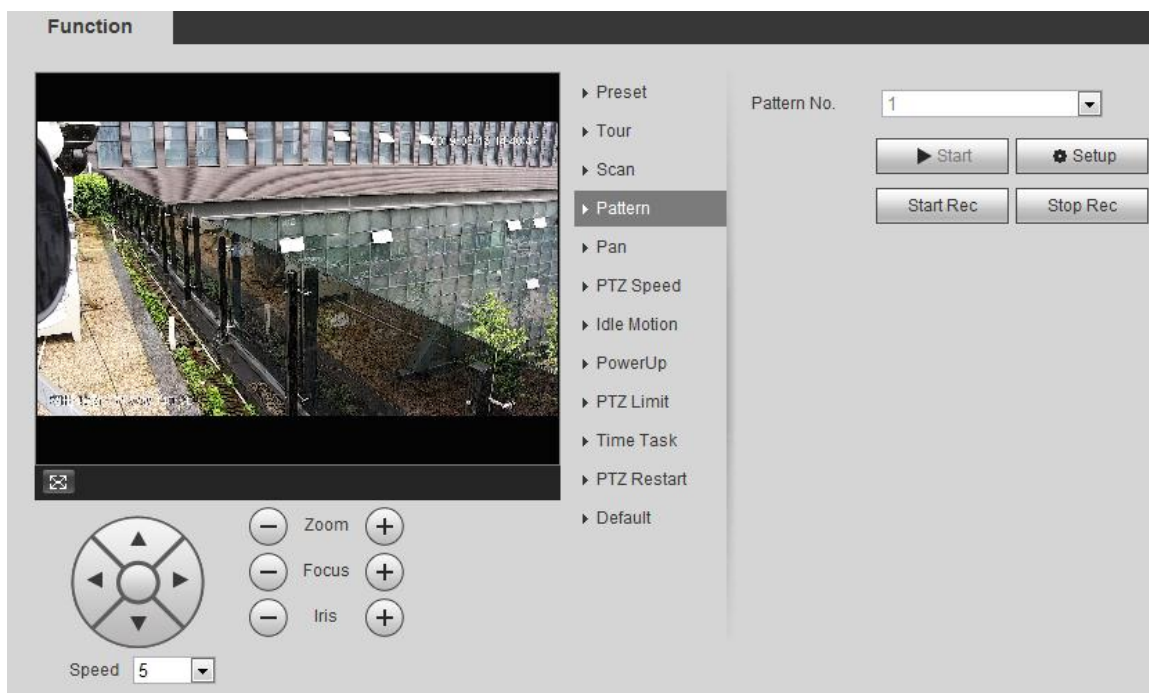

Step 2 Select the pattern number.

Step 3 Click **Setup**, and then click **Start Rec**. Adjust the parameters of direction, zoom, focus and iris according to the actual situation.

Step 4 Click **Stop Rec** to stop recording.

Step 5 Click **Start** to start patterning.
Click **Stop** to start patterning.

4.3.2.5 Pan

Enable Pan, the camera can realize continuous 360° horizontal rotation at a certain speed.

Step 1 Select **Setting > PTZ settings > Function > Pan**.

The **Pan** interface is displayed. See Figure 4-12.

Figure 4-12 Pan

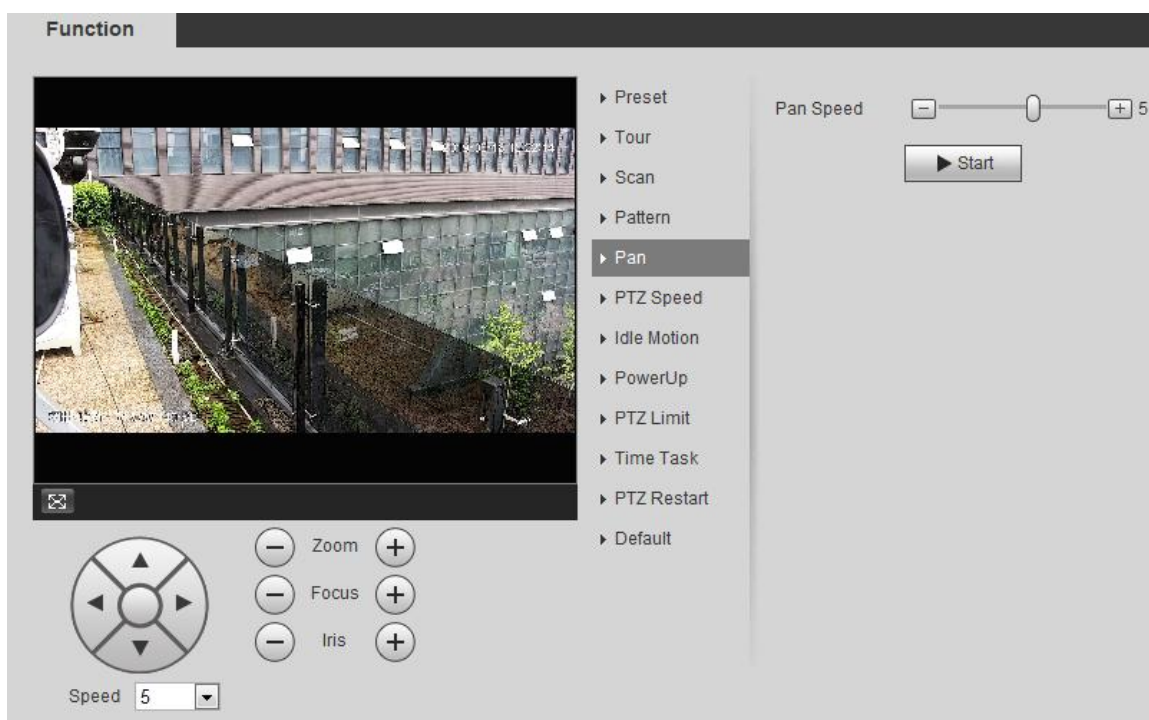

Step 2 Set the pan speed and click **Start**, and the camera starts horizontal rotation.
Click **Stop** to stop rotation.

4.3.2.6 PTZ Speed

PTZ speed means the rotation speed of the PTZ camera during touring, pattern, or auto tracking.

Step 1 Select **Setting > PTZ settings > Function > PTZ Speed**.

The **PTZ Speed** interface is displayed. See Figure 4-13.

Figure 4-13 PTZ speed

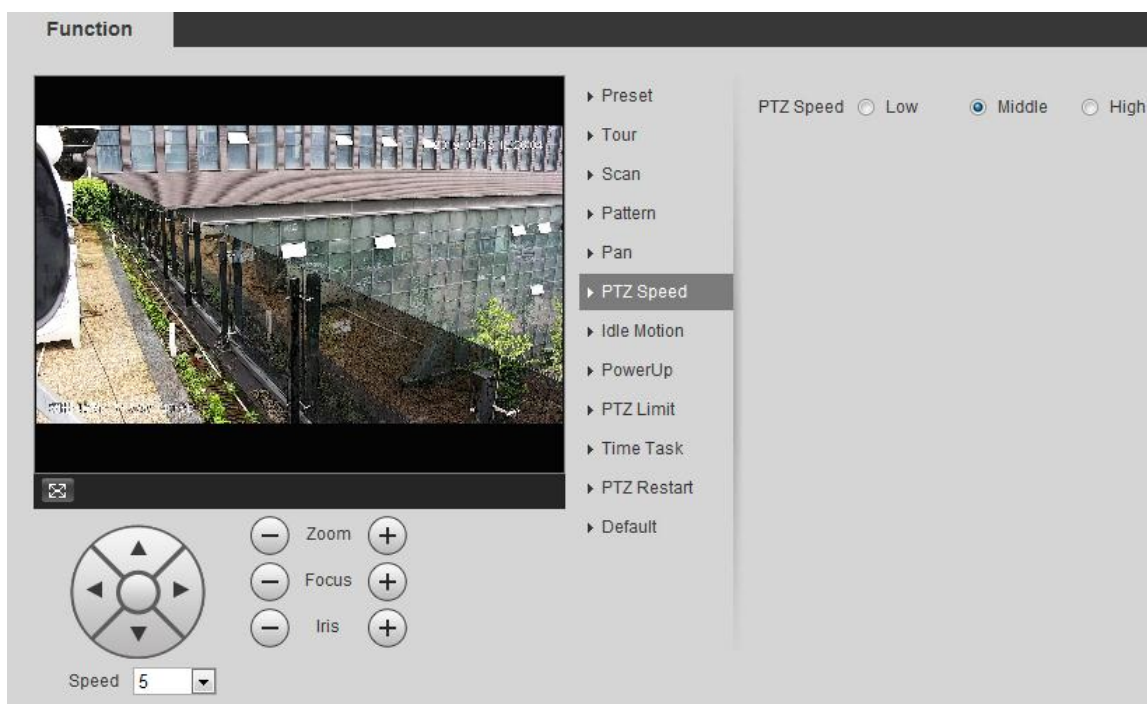

Step 2 Select the PTZ speed: **Low**, **Middle**, and **High**.



Speed under the direction buttons refers to the rotation angle of the PTZ camera for each press of the direction button.

4.3.2.7 Idle Motion

Idle motion means that the PTZ camera implements the operation which is configured in advance when it does not receive any valid command within the set time

Preparation

You have configured the PTZ motions, including preset, scan, tour, or pattern.

Procedure

Step 1 Select **Setting > PTZ settings > Function > Idle Motion**.

The **Idle Motion** interface is displayed. See Figure 4-14.

Figure 4-14 Idle motion

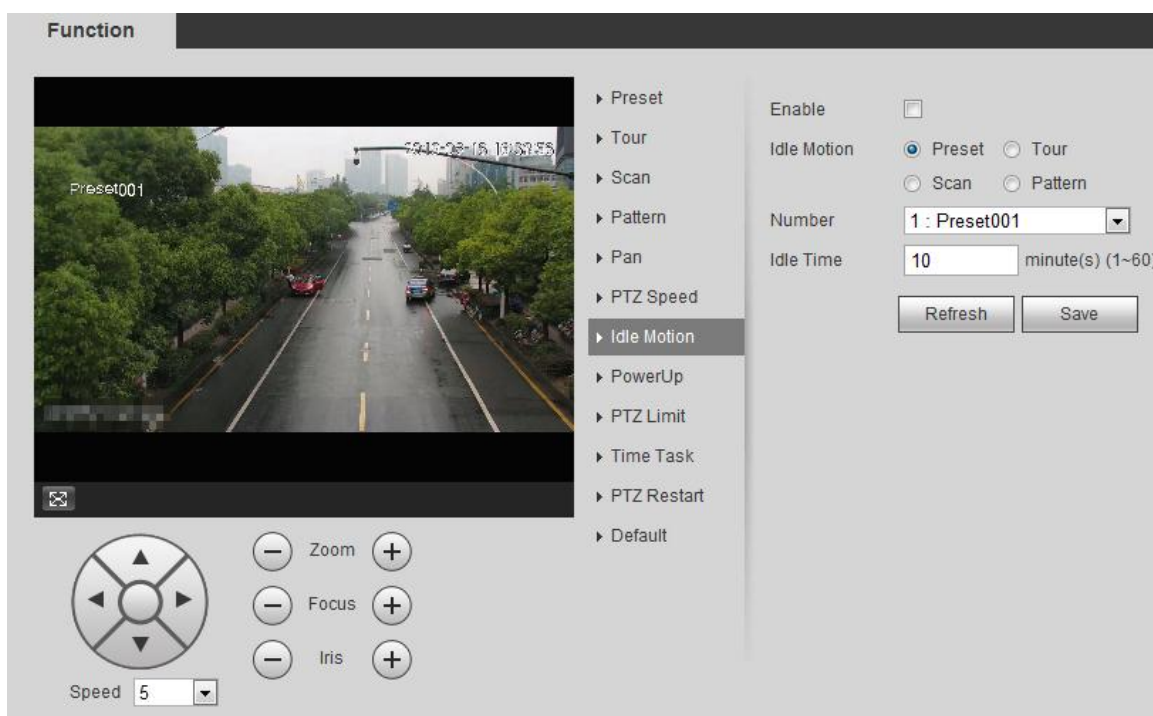

Step 2 Select the **Enable** check box to enable the idle motion function.

Step 3 Select the idle motion and set the idle time.

You need to select the corresponding number for some selected idle motions, such as **Preset001**.

Step 4 Click **Save**

4.3.2.8 PowerUp

After setting Powerup motion, the camera will perform the configured motion after it is power on.

Preparation

You have configured the PTZ motions, including preset, scan, tour, or pattern.

Procedure

Step 1 Select **Setting > PTZ settings > Function > PowerUp**.

The **PowerUp** interface is displayed. See Figure 4-15.

Figure 4-15 PowerUp

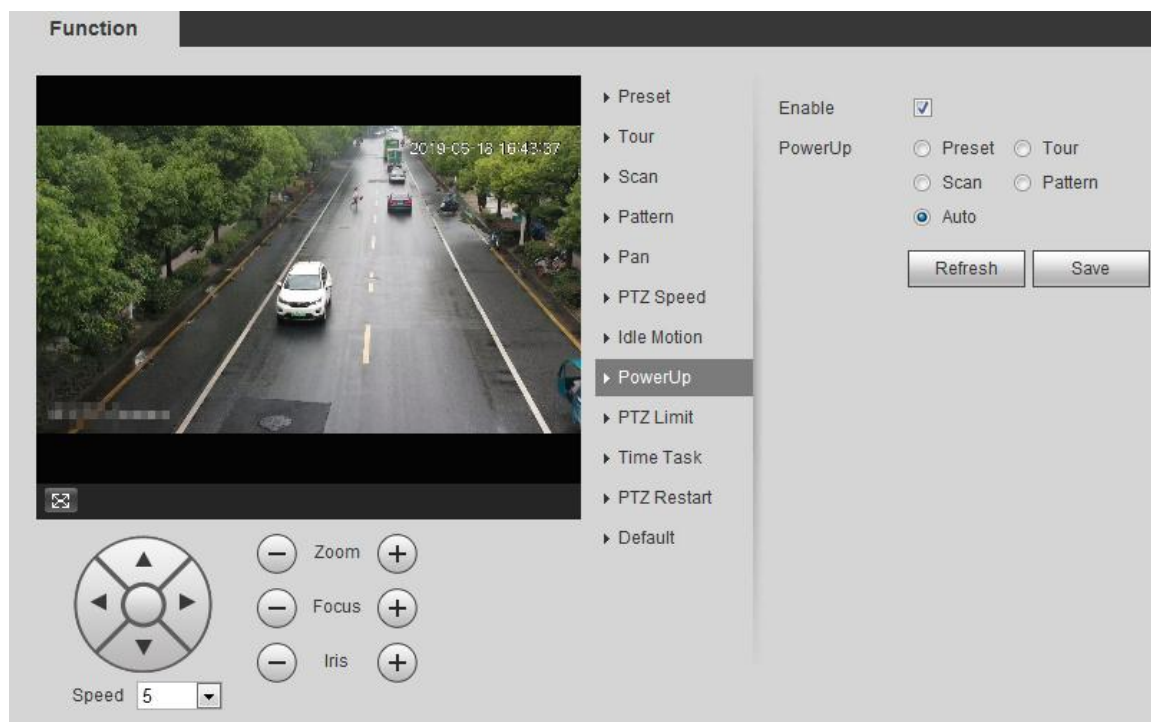

Step 2 Select the **Enable** check box to enable the power up function.

Step 3 Select the power up motion.



When you select **Auto**, the system will perform the last motion that is executed for more than 20 s before power-off.

Step 4 Click **OK**.

4.3.2.9 PTZ Limit

After setting PTZ limit, the camera can only rotate within the configured area.

Step 1 Select **Setting > PTZ settings > Function > PTZ Limit**.

The **PTZ Limit** interface is displayed. See Figure 4-16.

Figure 4-16 PTZ limit

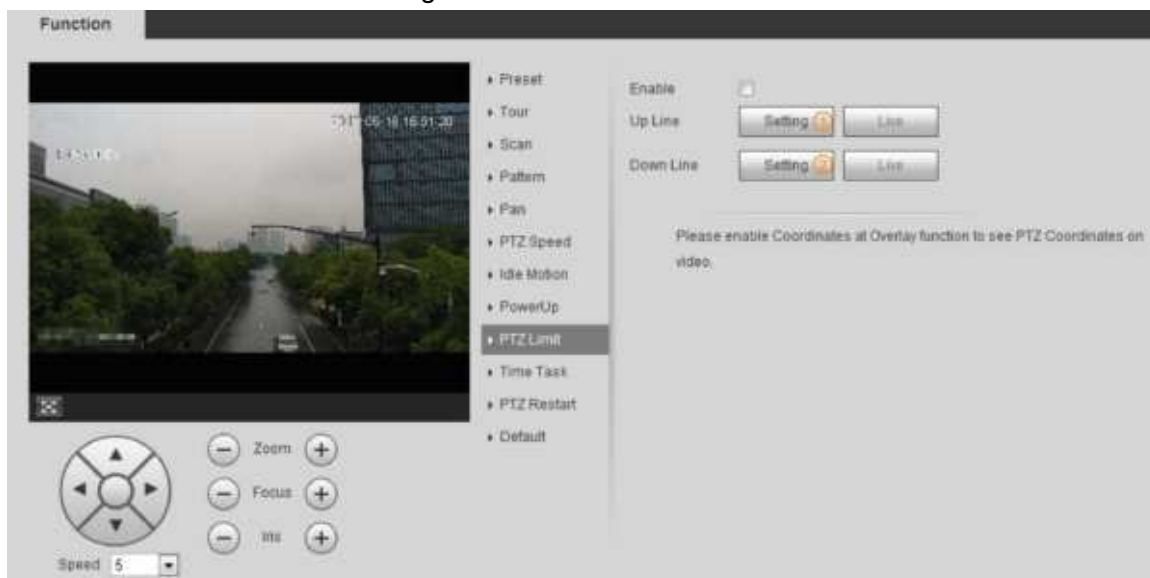

Step 2 Adjust the direction buttons, and then click **Setting** ① to set the up line; click **Setting** ② to set the down line.

Click **Live** to view the configured up line and down line.

Step 3 Select the **Enable** check box to enable the PTZ limit function.

4.3.2.10 Time Task

After setting time task, the camera performs the motions during the configured period.

Preparation

You have configured the PTZ motions, including preset, scan, tour, and pattern.

Procedure

Step 1 Select **Setting > PTZ settings > Function > Time Task**.

The **Time Task** interface is displayed. See Figure 4-17.

Figure 4-17 Time task

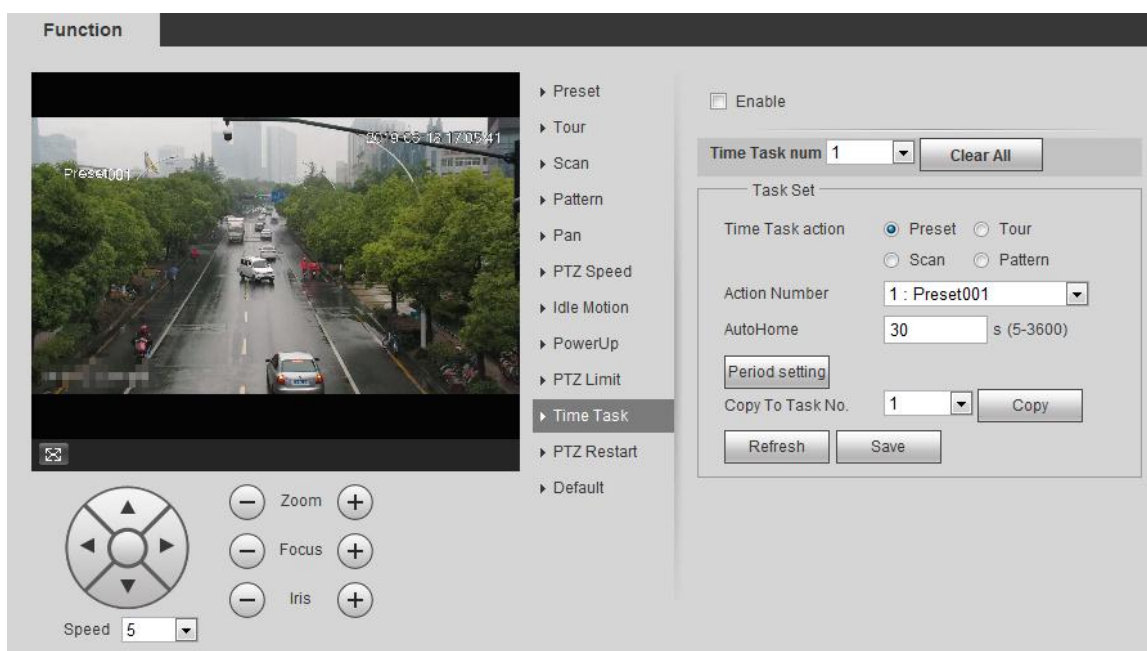

Step 2 Select the **Enable** check box to enable time task function.

Step 3 Select the time task number.

Step 4 Select the time task action.

You need to select the corresponding action number for some selected time task actions.

Step 5 Set the auto home time in **AutoHome**.

AutoHome: When you call PTZ, the time task will be interrupted. After setting **AutoHome** time, the camera will resume the time task automatically.

Step 6 Click **Period setting** to set the time of the task, and then click **Save**.

For setting arm time, see "5.1.1.1 Setting Period."

Step 7 Click **Save**.

Other Operations

You can copy the configurations of existing task number to other task number.

Step 1 Select the existing task number in **Time Task num**.

Step 2 Select the task number to be configured in **Copy To Task No**.

Step 3 Click **Copy**.

Step 4 Click **Save**.

4.3.2.11 PTZ Restart

This function can restart the PTZ camera.

Step 1 Select **Setting > PTZ settings > Function > PTZ Restart**.

The **PTZ Restart** interface is displayed. See Figure 4-18.

Figure 4-18 PTZ restart



Step 2 Click **PTZ Restart** to restart PTZ.

4.3.2.12 Default



Be careful when doing this operation. It will restore the camera to default configuration, and result in data loss.

Step 1 Select **Setting > PTZ settings > Function > Default**.

The **Default** interface is displayed. See Figure 4-19.

Figure 4-19 Default

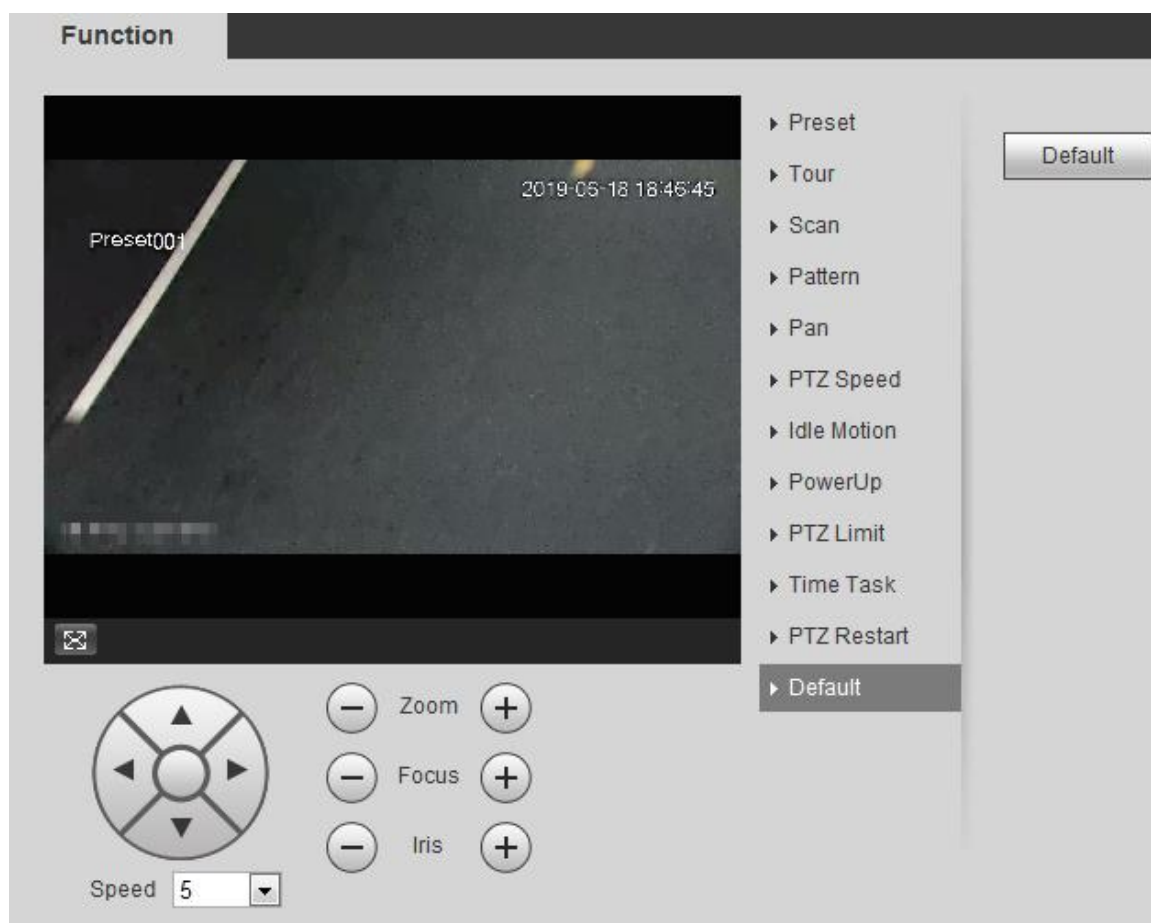

Step 2 Click **Default** and the PTZ function is restored to default.

4.3.3 Calling PTZ

Click **PTZ** on **Live** interface, and the PTZ configuration panel is displayed. You can control PTZ and call PTZ function.

4.3.3.1 PTZ Control





You can rotate device, zoom image, and adjust iris through PTZ control or virtual joystick. See Figure 4-20 and Figure 4-21.



Figure 4-20 PTZ control



Figure 4-21 Joystick



- : Rotate PTZ direction through direction button. PTZ supports eight directions: left/right/up/down/upper left/upper right/bottom left/bottom right. Click , and draw a box in the image, PTZ will rotate, focus and quickly position the defined scene.
- : Rotate PTZ direction through joystick. Select and hold , and drag it to the direction that you need, then PTZ will move to the defined direction.

- Speed: Measure the rotation speed. The higher the speed value is, the faster the speed becomes.
- Zoom, focus and iris: Click  or  to adjust zoom, focus and iris.

4.3.3.2 PTZ Function

Select the PTZ function from the drop-down list to call the corresponding functions, including Scan, Preset, Tour, Pattern, Pan, Go to, Assistant and Light Wiper. See Figure 4-22. For details, see Table 4-6. Before calling PTZ function, see "4.3.2 Configuring PTZ Function" to configure PZT function.



- If an external PTZ is connected to the camera, the configurations are valid only when the corresponding functions are available on the external PTZ.
- The range of PTZ function (such as preset and tour) depends on the PTZ protocol.

Figure 4-22 PTZ function

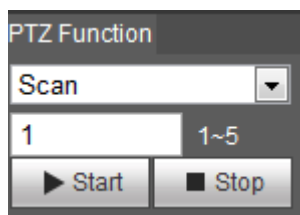

Table 4-6 Description of PTZ function

Parameter	Description
Scan	Set the scan number and click Start , the camera moves horizontally at a certain speed between the set left and right limit. Click Stop to stop scanning.
Preset	Set the preset number and click Go to , the camera quickly positions the corresponding preset.
Tour	Set the tour number and click Start , the camera moves in the order of the selected presets. Click Stop to stop touring.
Pattern	Set the pattern number and click Start , the camera moves continuously according to the operation recording. Click Stop to stop patterning. Operation recording includes the information of manual operation, focus and zoom.
Pan	Click Start , and the camera rotates 360° at a certain speed in horizontal direction.
Go to	Set the horizontal angle, vertical angle, and zoom. Click Go to to position a certain point accurately.
Assistant	Set the assistant number and click Aux On to enable the corresponding assistant function, and then you can adjust the camera. Click Aux On to disable the corresponding assistant function.

Parameter	Description
Light/Wiper	Set the light or wiper of the camera. <ul style="list-style-type: none"> Click Enable to enable light/wiper function. Click Disable to disable light/wiper function.

4.4 Playback

This section introduces playback related functions and operations, including video playback and picture playback.



- Before playing back video, configure record time range, record storage method, record schedule and record control. For details, see "5.1.1.2.1 Setting Record Plan."
- Before playing back picture, configure snapshot time range, snapshot storage method, snapshot plan. For details, see "5.1.1.3.1 Setting Snapshot Plan."
- When using smart card, make sure that the card has been authenticated before using.

4.4.1 Playback Interface

Click the **Playback** tab, and the **Playback** interface is displayed. See Figure 4-23 and Figure 4-24. For details, see Table 4-7.

Figure 4-23 Video playback



Figure 4-24 Picture playback

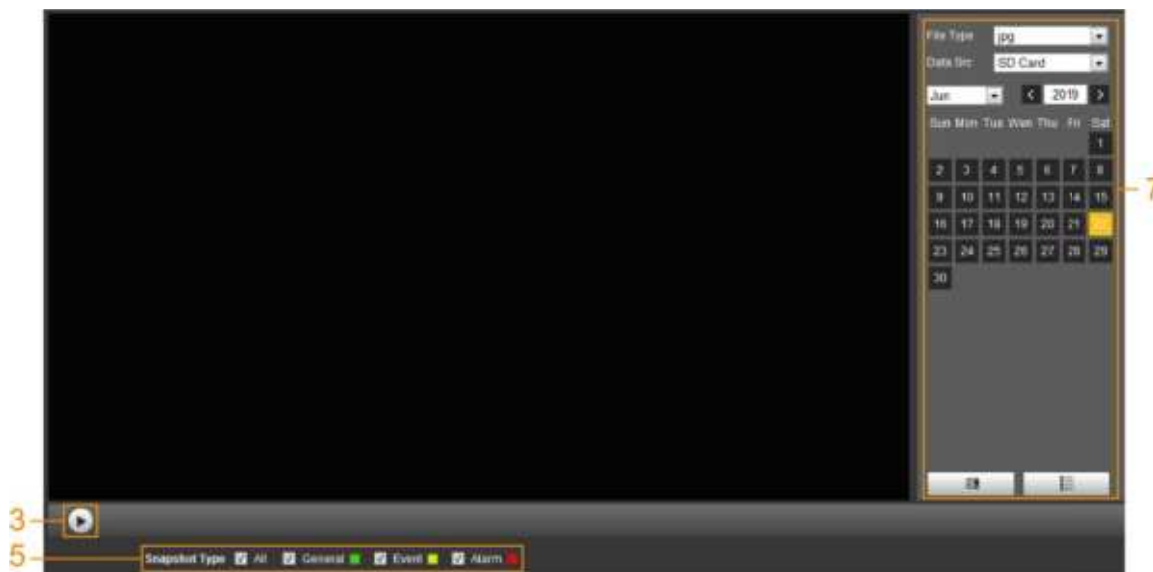





















Table 4-7 Playback interface description

No	Function	Description
1	Fisheye	<p>Click , you can select display mode according to the installation mode during playback.</p> <p></p> <p>This function is only available on fisheye cameras.</p>
	Rules Info	<p>Click , intelligent rules and object detection box are displayed. It is enabled by default.</p> <p></p> <p>Rules Info is valid only when you enabled the rule during recording.</p>
2	Sound	<p>Controls the sound during playback.</p> <ul style="list-style-type: none"> : Mute mode. : Vocal state. You can adjust the sound.

No	Function	Description
3	Play control bar	<p>Controls playback.</p> <ul style="list-style-type: none"> ● : Click the icon to play back recorded videos. ● : Click the icon to stop playing back recorded videos. ● : Click the icon to play the next frame. <p></p> <p>When you enable the function of playing video by frame, you need to stop playback.</p> <ul style="list-style-type: none"> ● : Click the icon to slow down the playback. ● : Click the icon to speed up the playback.
4	Progress bar	<p>Displays the record type and the corresponding period.</p> <ul style="list-style-type: none"> ● Click any point in the colored area, and the system will play back the recorded video from the selected moment. ● Each record type has its own color, and you can see their relations in Record Type bar.
5	Record/Snapshot Type	<p>Select the record type or snapshot type:</p> <ul style="list-style-type: none"> ● Record type includes General, Event, Alarm, Manual ● Snapshot type includes General, Event, Alarm
6	Assistant	<ul style="list-style-type: none"> ● : You can zoom video image of the selected area through two operations. <ul style="list-style-type: none"> ◇ Click the icon, and then select an area in the video image to zoom in; right-click on the image to resume the original size. In zoom in state, drag the image to check other area. ◇ Click the icon, and then scroll the mouse wheel in the video image to zoom in or out. ● : Click the icon to capture one picture of the current video, and it will be saved to the configured storage path. <p></p> <p>About viewing or configuring storage path, see "4.5.2.5 Path."</p>
7	Playback video	You can select the file type, data source, and record date.
8	Video clip	Clip a certain recorded video and save it. For details, see "4.4.3 Clipping Video."

No	Function	Description
9	Time format of progress bar	Includes 4 time formats:  ,  ,  ,  . Take  as an example, the whole progress stands for 24 hours.

4.4.2 Playing back Video or Picture

This section introduces the operation of video playback and picture playback. This section takes video playback as an example.

Step 1 Select **dav** from the **Record Type** drop-down list and **SD card** from the **Data Src** drop-down list. See Figure 4-25.

Select **jpg** from **Record Type** drop-down list when playing back pictures, and you do not need to select data source.

Figure 4-25 File type selection

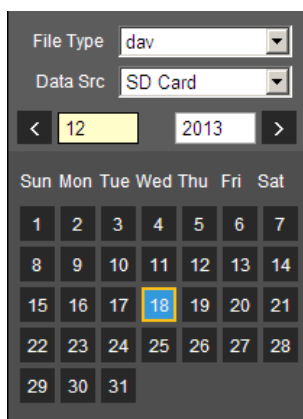

Step 2 Select the record type in **Record Type**. See Figure 4-26.

Figure 4-26 Record type selection



When selecting **Event** as the record type, you can select the specific event types from the playback file list, such as **Motion Detection**, **Video Tamper** and **Scene Changing**. See Figure 4-27.

Figure 4-27 Specific event types

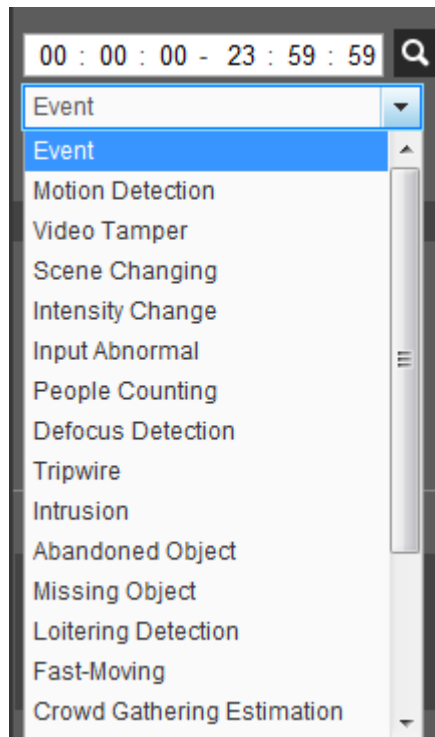

Step 3 Select the month and year of the video that you want to play.



Those dates with blue color indicate there were videos recorded in those days.

Step 4 Play video.

- Click  in the control bar.
The system plays the recorded video of the selected date (in the order of time).
- Click any point in the colored area on the progress bar. See Figure 4-28.
The playback starts from that moment.

Figure 4-28 Progress bar



- Click , the video files of the selected date would be listed. See Figure 4-29.

Enter the start time and end time, and then click  to search all files between the start time and end time. Double-click the file in the list, and the system plays the video and displays file size, starting time, and ending time.

Figure 4-29 Playback file list (1)



4.4.3 Clipping Video

Step 1 Click , the video files of the selected date are listed.

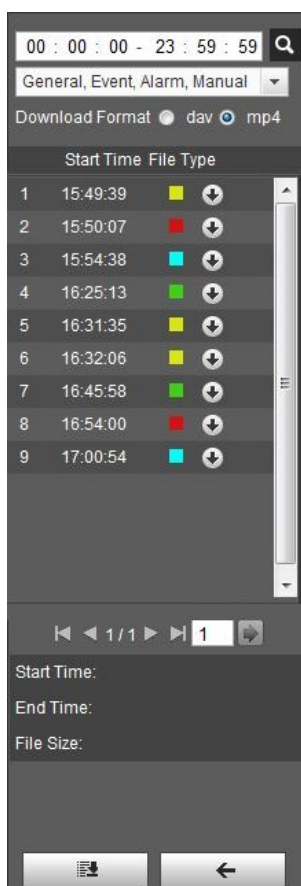
Step 2 Select **dav** or **mp4** in **Download Format**.

Step 3 Click on the progress bar to select the start time of the target video, and then click



. See Figure 4-30.

Figure 4-30 Clipping video

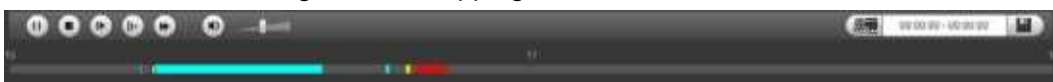

Step 4 Click again on the progress bar to select the end time of the target video, and then click



Step 5 Click  to download the video.

The system will prompt that it cannot play back and download at the same time.

Step 6 Click **OK**.

The playback stops and the clipped file is saved in the configured storage path. For the configuration of storage path, see "4.5.2.5 Path."

4.4.4 Downloading Video or Picture

Download video or picture to a defined path. You can download single video or picture file, or download them in batches. This section takes downloading video as an example.



- Playback and downloading at the same time is not supported.
- Operations might vary with different browsers, and the actual product shall prevail.
- For details of viewing or setting storage path, see "4.5.2.5 Path."

4.4.4.1 Downloading Single File

Step 1 Select **dav** from **Record Type** drop-down list and **SD card** from the **Data Src** drop-down list.

Select **jpg** from **Record Type** drop-down list when playing back pictures, and you do not need to select data source.

Step 2 Click , the video files of the selected date are listed. See Figure 4-29.

Step 3 Select **dav** or **mp4** in **Download Format**. Click  next to the file to be downloaded.

The system starts to download the file to the configured path. When downloading pictures, you do not need to select the download format.

4.4.4.2 Downloading Files in Batches

Step 1 Click  on the playback interface.

The **Batch Download** interface is displayed. See Figure 4-31.

Figure 4-31 Batch download

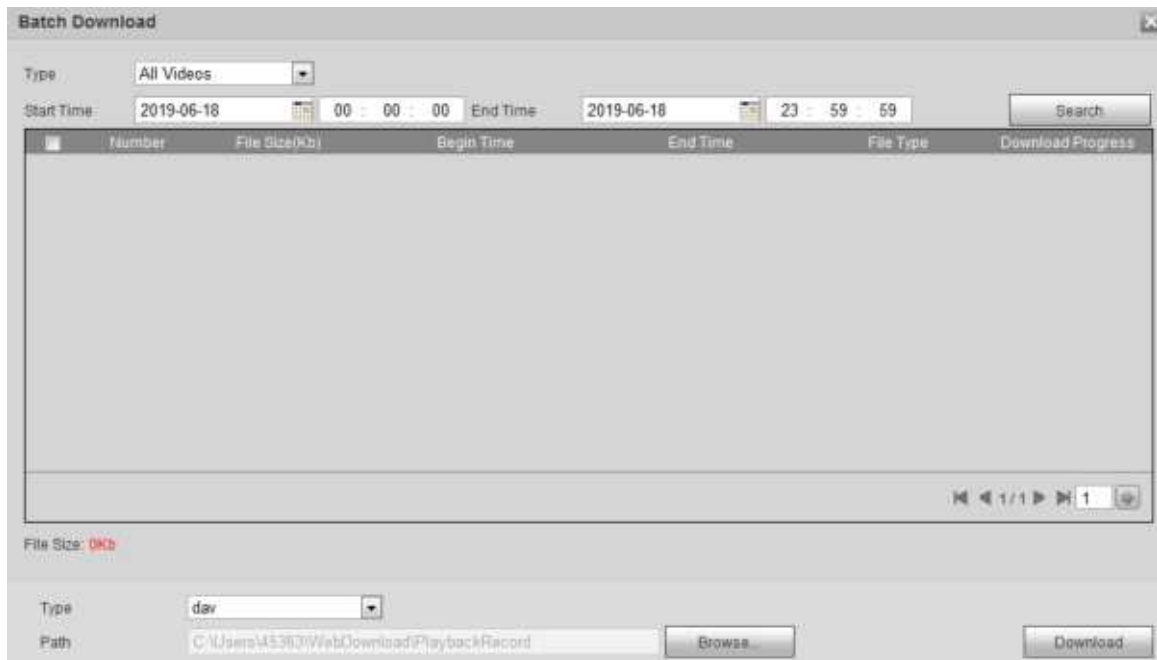

Step 2 Select the record type, set the start time and end time, and then click **Search**.

The searched files are listed.

Step 3 Select the files to be downloaded, select **dav** or **mp4** from **Format** drop-down list, and then set the storage path. Click **Download**.

The system starts to download the file to the configured path. When downloading picture, you do not need to select the download format.

4.5 Camera

This section introduces the camera setting, including conditions, video and audio.



Camera parameters of different devices might vary, and the actual product shall prevail.

4.5.1 Conditions

Configure camera parameters of the camera to ensure surveillance goes properly.

4.5.1.1 Conditions

Configure camera parameters according to the actual situation, including picture, exposure, backlight and white balance.

4.5.1.1.1 Interface Layout

Configure camera parameters to improve the scene clarity, and ensure that surveillance goes properly. See Figure 4-32.

- You can select from normal, day and night mode to view the configuration and the effect of the selected mode, such as picture, exposure, and backlight.
- Camera with PZT function supports zoom, focus and iris operations. See Figure 4-33.



Configure speed, click direction button,  and  to adjust the direction, zoom, focus and iris and so on, to adjust the camera to the proper position.

Figure 4-32 Camera conditions

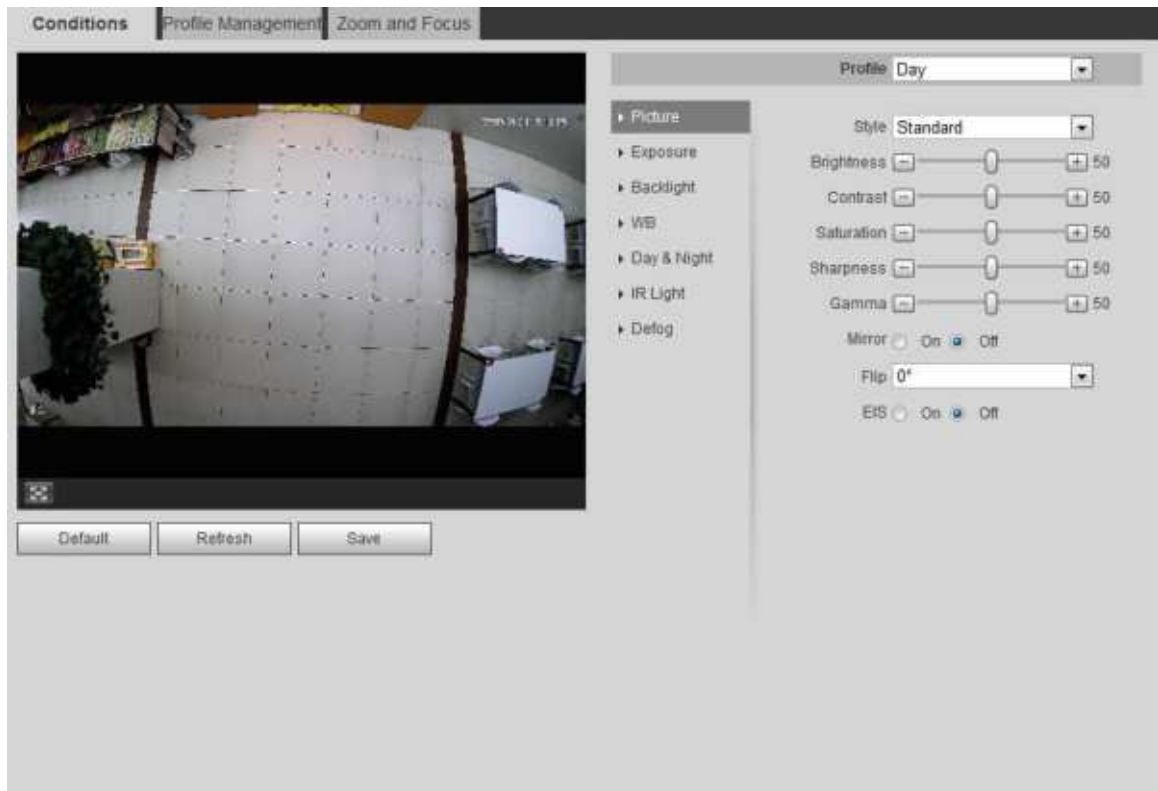
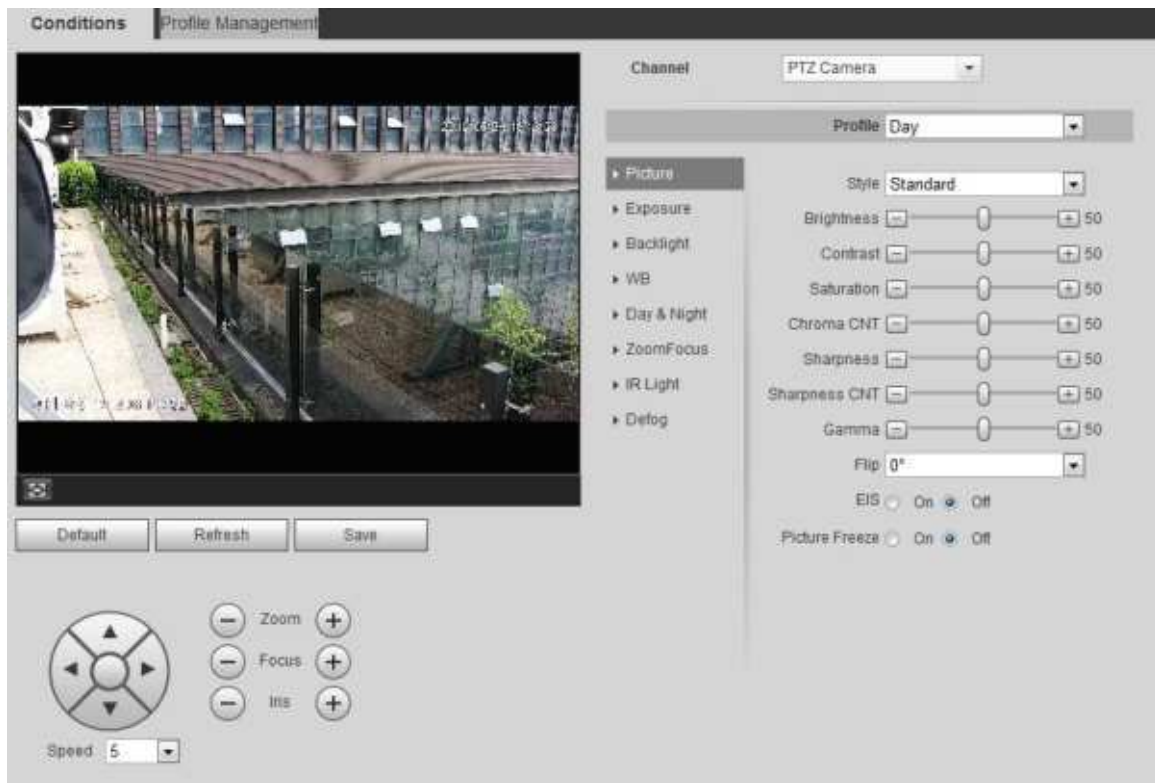

Figure 4-33 Camera conditions (PTZ camera)



4.5.1.1.2 Picture

You can configure picture parameters as needed.

Step 1 Select **Setting > Camera > Conditions > Conditions > Picture**.

The **Picture** interface is displayed. See Figure 4-34.

Figure 4-34 Picture

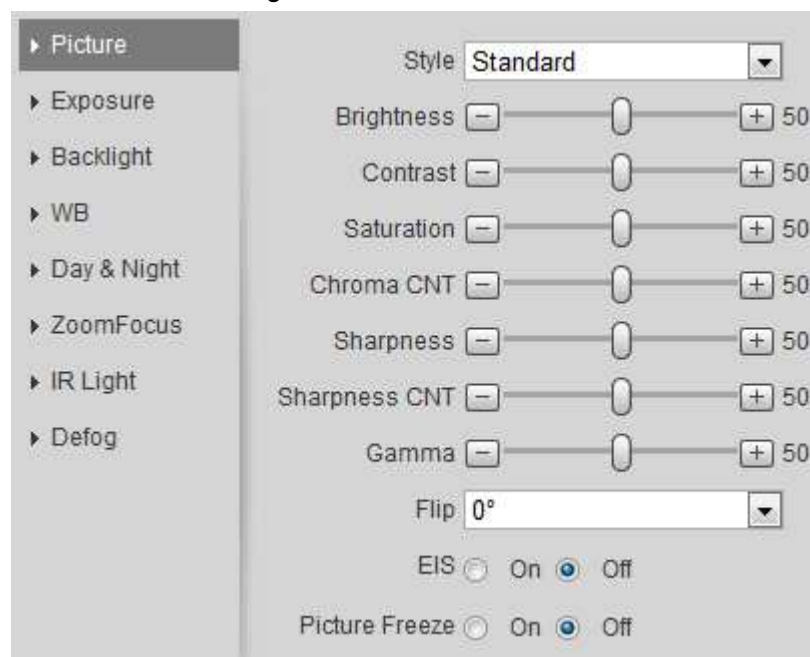

Step 2 Configure picture parameters. For details, see Table 4-8.

Table 4-8 Description of picture parameters

Parameter	Description
Style	Select the picture style from soft, standard and vivid. <ul style="list-style-type: none"> ● Soft: Default image style, displays the actual color of the image. ● Standard: The hue of the image is weaker than the actual one, and contrast is smaller. ● Vivid: The image is more vivid than the actual one.
Brightness	Changes the value to adjust the picture brightness. The higher the value is, the brighter the picture will be, and the smaller the darker. The picture might be hazy if the value is configured too big.
Contrast	Changes the contrast of the picture. The higher the value is, the more the contrast will be between bright and dark areas, and the smaller the less. If the value is set too big, the dark area would be too dark and bright area easier to get overexposed. The picture might be hazy if the value is set too small.
Saturation	Makes the color deeper or lighter. The higher the value is, the deeper the color will be, and the lower the lighter. Saturation value does not change image brightness.
Sharpness	Changes the sharpness of picture edges. The higher the value is, the clearer the picture edges will be, and if the value is set too big, picture noises are more likely to appear.
Gamma	Changes the picture brightness and improves the picture dynamic range in a non-linear way. The higher the value is, the brighter the picture will be, and the smaller the darker.
Mirror	Select On , and the picture would display with left and right side reversed.
Flip	Changes the display direction of the picture, see the options below. <ul style="list-style-type: none"> ● 0°: Normal display. ● 90°: The picture rotates 90° clockwise. ● 180°: The picture rotates 90° counterclockwise. ● 270°: The picture flips upside down.  <p>For some models, please set the resolution to be 1080p or lower when using 90° and 180°. For details, see "4.5.2.1 Video."</p>
EIS	Corrects the device shaking with difference comparison algorithm and improves the image clarity, effectively solves the picture shaking problem.
Picture Freeze	When you call a preset, the image displays the preset location, not the rotation image.

Step 3 Click **Save**.

4.5.1.1.3 Exposure

Configure iris and shutter to improve image clarity.



Cameras with true WDR do not support long exposure when WDR is enabled in **Backlight**.

Step 1 Select **Setting > Camera > Conditions > Conditions > Exposure**.

The **Exposure** interface is displayed. See Figure 4-35.

Figure 4-35 Exposure

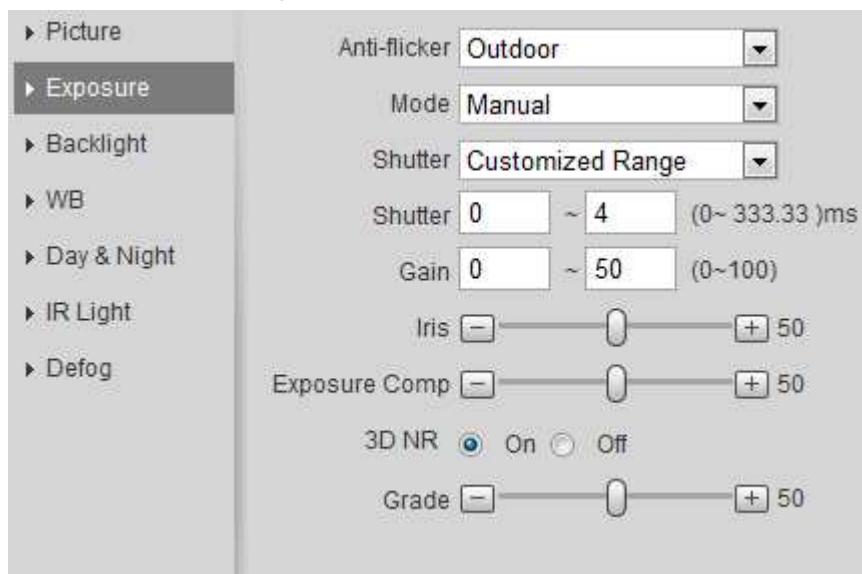

Step 2 Configure exposure parameters. For details, see Table 4-9.

Table 4-9 Description of exposure parameters

Parameter	Description
Anti-flicker	<p>You can select from 50 Hz, 60 Hz and Outdoor.</p> <ul style="list-style-type: none"> 50 Hz: When the electric supply is 50 Hz, the system adjusts the exposure according to ambient light automatically to ensure that there is no stripe appears. 60 Hz: When the electric supply is 60 Hz, the system adjusts the exposure according to ambient light automatically to ensure that there is no stripe appears. Outdoor: You can select any exposure mode as needed.

Parameter	Description
Mode	<p>Device exposure modes.</p> <ul style="list-style-type: none"> ● Auto: Adjusts the image brightness according to the actual condition automatically. ● Gain Priority: When the exposure range is normal, the system prefers the configured gain range when auto adjusting according to the ambient lighting condition. If the image brightness is not enough and the gain has reached upper or lower limit, the system adjusts shutter value automatically to ensure the image at ideal brightness. You can configure gain range to adjust gain level when using gain priority mode. ● Shutter priority: When the exposure range is normal, the system prefers the configured shutter range when auto adjusting according to the ambient lighting condition. If the image brightness is not enough and the shutter value has reached upper or lower limit, the system adjusts gain value automatically to ensure the image at ideal brightness. ● Iris priority: The iris value is set to a fixed value, and the device adjusts shutter value then. If the image brightness is not enough and the shutter value has reached upper or lower limit, the system adjusts gain value automatically to ensure the image at ideal brightness. ● Manual: Configure gain and shutter value manually to adjust image brightness.  <p>When the Anti-flicker is set to Outdoor, you can select Gain priority or Shutter priority in the Mode list.</p>
Exposure Comp	Sets the value, and it ranges from 0 to 50. The higher the value is, the brighter the image will be.
Shutter	Set the effective exposure time. The smaller the value, the shorter the exposure time will be.
Shutter range	When selecting Shutter Priority or Manual in Mode , and setting Customized Range in Shutter , you can set shutter range, and the unit is ms.
Gain	When selecting Gain Priority or Manual in Mode , you can set shutter range. With minimum illumination, the camera increases Gain automatically to get clearer images.
Iris	When selecting Aperture Priority in Mode , you can set iris range.

Parameter	Description
Auto Iris	This configuration is available only when the camera is equipped with auto-iris lens. <ul style="list-style-type: none"> When auto iris is enabled, the iris size changes automatically according to the ambient lighting condition, and the image brightness changes accordingly. When auto iris is disabled, the iris stays at full size and does not change no matter how ambient lighting condition changes.
2D NR	Average single-frame dots and other dots around to reduce noise.
3D NR	Works with multi-frame (no less than 2 frames) images and reduces noise by using the frame information between previous and latter frames.
Grade	This configuration is available only when the 3D DNR is enabled. The higher the DNR level is, the better the result will be.

Step 3 Click **Save**.

4.5.1.1.4 Backlight

You can select backlight mode from Auto, BLC, WDR, and HLS.

Step 1 Select **Setting > Camera > Conditions > Conditions > Backlight**.

The **Backlight** interface is displayed. See Figure 4-36.

Figure 4-36 Backlight

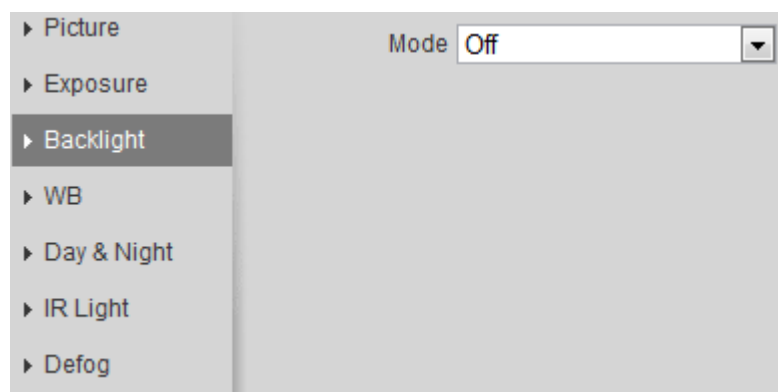

Step 2 Configure backlight parameters. For details, see Table 4-10.

Table 4-10 Description of backlight parameters

Backlight mode	Description
Auto	The system adjusts image brightness according to ambient lighting condition automatically to ensure image clarity.
BLC	Enable BLC, the camera can get clearer image of the dark areas on the target when shooting against light. You can select Default mode or Customized mode. <ul style="list-style-type: none"> When in Default mode, the system adjusts exposure according to ambient lighting condition automatically to ensure the clarity of the darkest area. When in Customized mode, the system auto adjusts exposure only to the set area according to ambient lighting condition to ensure the image of the set area at ideal brightness.

Backlight mode	Description
WDR	<p>The system dims bright areas and compensates dark areas to ensure the clarity of all the area. The higher the value is, the brighter the dark will be, but the more the noise will be.</p>  <p>There might be a few seconds of video loss when the device is switching to WDR mode from other mode.</p>
HLS	<p>Enable HLS when extreme strong light is in the environment (such as toll station or parking lot), the camera will dim strong light, and reduce the size of Halo zone to lower the brightness of the whole image, so that the camera can capture human face or car plate detail clearly. The higher the value is, the more obvious the HLS effect will be.</p>

Step 3 Click **Save**.

4.5.1.1.5 WB

WB function makes the image color display precisely as it is. When in WB mode, white objects would always display white color in different environments.

Step 1 Select **Setting > Camera > Conditions > Conditions > WB**.

The **WB** interface is displayed. See Figure 4-37.

Figure 4-37 WB

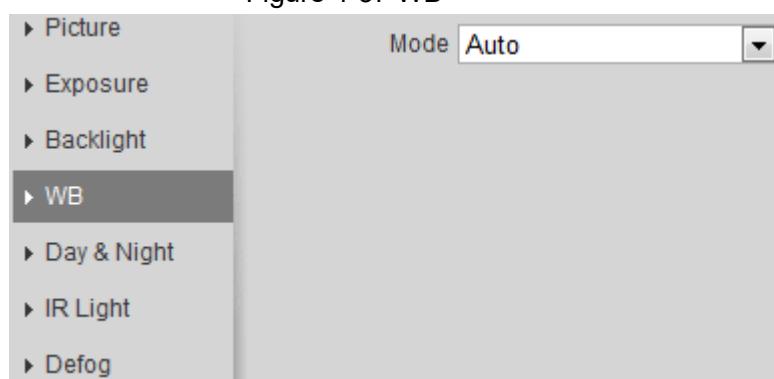

Step 2 Configure WB parameters. For details, see Table 4-11.

Table 4-11 Description of WB parameters

WB mode	Description
Auto	The system compensates WB according to color temperature to ensure color precision.
Natural	The system auto compensates WB to environments without artificial light to ensure color precision.
Street Lamp	The system compensates WB to outdoor night scene to ensure color precision.
Outdoor	The system auto compensates WB to most outdoor environments with natural or artificial light to ensure color precision.
Manual	Configure red and blue gain manually; the system auto compensates WB according to color temperature.

WB mode	Description
Regional	The system compensates WB only to the set area according to color temperature to ensure color precision.
Custom	

Step 3 Click **Save**.

4.5.1.1.6 Day & Night

Configure the display mode of the image. The system switches between color and black-and-white mode according to the actual condition.

Step 1 Select **Setting > Camera > Conditions > Conditions > Day & Night**.

The **Day & Night** interface is displayed. See Figure 4-38.

Figure 4-38 Day and night

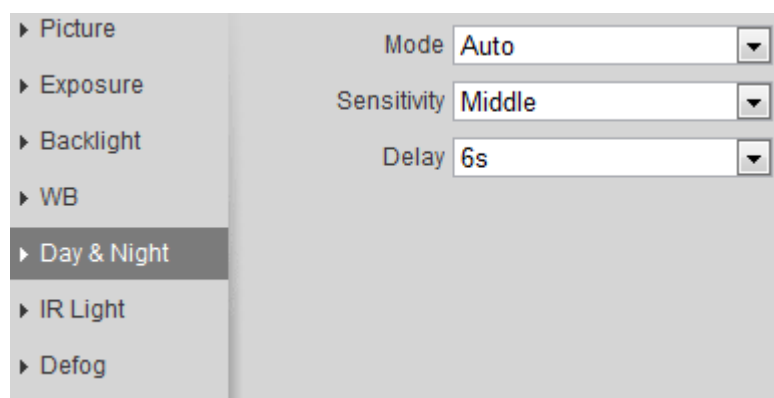

Step 2 Configure day and night parameters. For details, see Table 4-12.

Table 4-12 Description of day and night parameters

Parameter	Description
Mode	<p>You can select device display mode from Color, Auto, and B/W.</p>  <p>Day & Night configuration is independent from profile management configuration.</p> <ul style="list-style-type: none"> ● Color: The system displays color image. ● Auto: The system switches between color and black-and-white display according to the actual condition. ● B/W: The system displays black-and-white image.
Sensitivity	<p>This configuration is available only when you set Auto in Mode.</p> <p>You can configure camera sensitivity when switching between color and black-and-white mode.</p>
Delay	<p>This configuration is available only when you set Auto in Mode.</p> <p>You can configure the delay when camera switching between color and black-and-white mode. The lower the value is, the faster the camera switches between color and black-and-white mode.</p>

Step 3 Click **Save**.

4.5.1.1.7 Zoom and Focus

Initialize lens to adjust zoom and focus. Only PTZ camera supports lens initialization.

Step 1 Select **Setting > Camera > Conditions > Conditions > ZoomFocus**.

The **ZoomFocus** interface is displayed. See Figure 4-39.

Figure 4-39 Zoom and focus

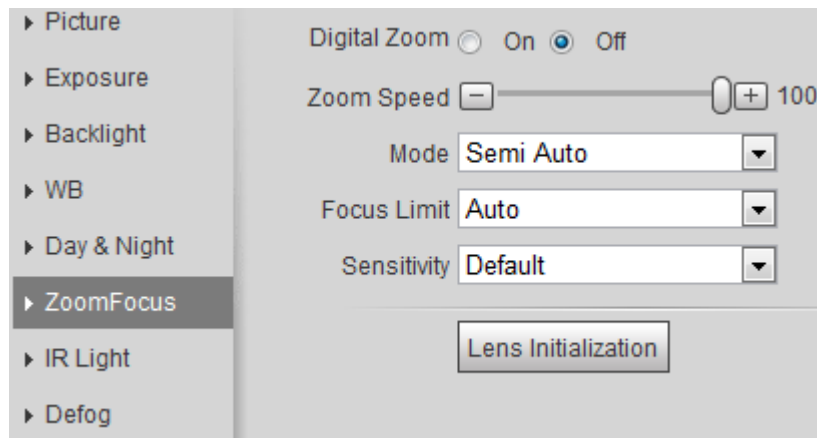

Step 2 Configure zoom and focus parameters. For details, see Figure 4-13.

Table 4-13 Description of zoom and focus parameters

Parameter	Description
Digital Zoom	Select On to enable digital zoom function. After the optical zoom reached the upper limit, enable digital zoom function, you still can do digital zoom operation.
Zoom Speed	Adjusts zoom speed. The higher the value is, the higher the speed will be.
Mode	Sets focus mode. <ul style="list-style-type: none"> • Auto: When image moves or object changes in the scene, the camera will focus automatically. • Semi Auto: Click or corresponding to Focus or Zoom, the camera will focus. Calling preset, positioning accurately or rotating PTZ also will trigger focus. • Manual: Click or corresponding to Focus to adjust the focus.
Focus Limit	When the focus length is too short, the camera will focus on the dome cover. Sets the shortest focus distance to avoid focusing on the dome cover. You can also change the focus speed by changing focus length.
Sensitivity	The sensitivity of triggering focus. The higher the value is, the easier the focus will be triggered.

Step 3 Click **Save**.



Click **Lens Initialization**, the lens will adjust the zoom and focus parameters.

4.5.1.1.8 IR Light

This configuration is available only when the device is equipped with IR light.

Step 1 Select **Setting > Camera > Conditions > Conditions > IR Light**.

The **IR Light** interface is displayed. See Figure 4-40.

Figure 4-40 IR light

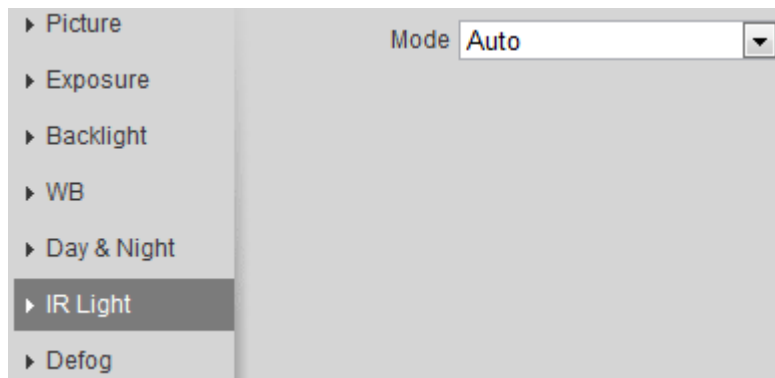

Step 2 Configure IR light parameters. For details, see Table 4-14.

Table 4-14 Description of IR light parameters

IR light mode	Description
Manual	Adjust the brightness of IR light manually, and then the system will supply IR light to the image accordingly.
Auto	The system adjusts the IR light intensity according to the ambient lighting condition.
Smart IR	
ZoomPrio	<p>The system adjusts the IR light intensity automatically according to the change of the ambient light.</p> <ul style="list-style-type: none"> When the ambient light turns darker, the system turns on the low beam lights first, if the brightness is still not enough, it turns on the high beam lights then. When the ambient light turns brighter, the system dims high beam lights until they are off, and then the low beam lights. When the focus reaches certain wide angle, the system will not turn on high beam light in order to avoid over-exposure in short distance. In the meantime, you can configure light compensation manually to fine-tune IR light intensity.
Off	IR light is off.

Step 3 Click **Save**.

4.5.1.1.9 Defog

The image quality is compromised in foggy or hazy environment, and defog can be used then to improve image clarity.

Step 1 Select **Setting > Camera > Conditions > Conditions > Defog**.

The **Defog** interface is displayed. See Figure 4-41.

Figure 4-41 Defog

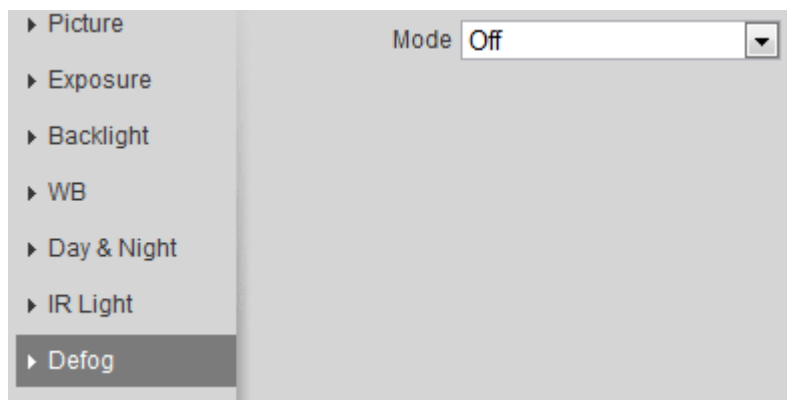

Step 2 Configure defog parameters. For details, see Table 4-15.

Table 4-15 Description of defog parameters

Defog	Description
Manual	Configure function intensity and atmospheric light mode manually, and then the system adjusts image clarity accordingly. Atmospheric light mode can be adjusted automatically or manually.
Auto	The system adjusts image clarity according to the actual condition.
Off	Defog function is disabled.

Step 3 Click **Save**.

4.5.1.1.10 Fisheye

Select install mode and record mode according to the actual installation scene. When the camera accesses to the platform with corrective stream, the platform displays the corrective image.



This function is only available on fisheye device.

Step 1 Select **Setting > Camera > Conditions > Conditions > Fisheye**.

The **Fisheye** interface is displayed. See Figure 4-42.

Figure 4-42 Fisheye

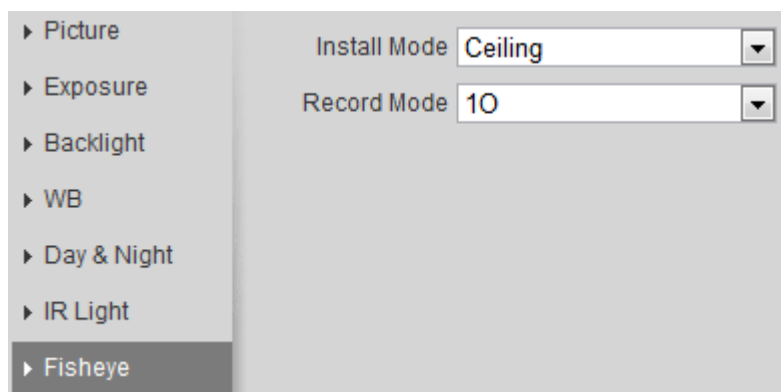

Step 2 Set install mode and record mode. For details, see Table 4-16.

Table 4-16 Description of fisheye parameters

Parameter	Description
Install Mode	You can select Ceiling , Wall , or Ground .
Record Mode	<ul style="list-style-type: none"> • 1O: The original image before correction. • 1P: 360°rectangular panoramic image. • 2P: When the install mode is Ceiling or Ground, you can set this mode. Two associated 180° rectangular image screens, and at any time, the two screens form a 360° panoramic image. • 1R: Original image screen + independent sub-screen. You can zoom or drag the image in all the screens. • 2R: Original image screen + two independent sub-screens. You can zoom or drag the image in all the screens. • 4R: Original image screen + four independent sub-screens. You can zoom or drag the image in all the screens. • 1O + 3R: Original image screen + three independent sub-screens. You can zoom or drag the image in original image screen, and move the image (upper and lower) in sub-screens to adjust the vertical view.

Step 3 Click **Save**.

4.5.1.2 Profile Management

The surveillance system works in different ways as profile configured in different time.

Step 1 Select **Setting > Camera > Conditions > Profile Management**.

The **Profile Management** interface is displayed.

Step 2 Manage profile.

- When **Profile Management** is set as **General**, the surveillance system works under **General** configuration.

Figure 4-43 General

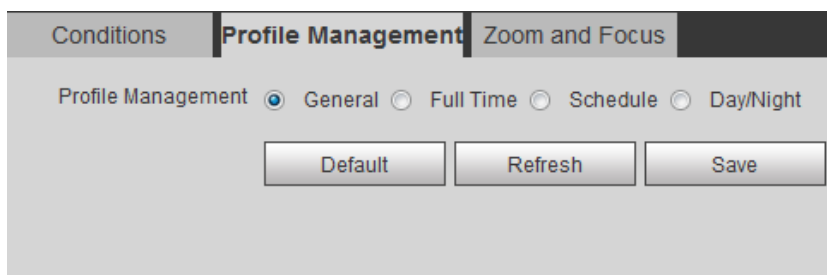

- When **Profile Management** is set as **Full Time**, you can select **Day** or **Night** in the **Always Enable** list, the surveillance system works under **Always Enable** configuration.

Figure 4-44 Full time

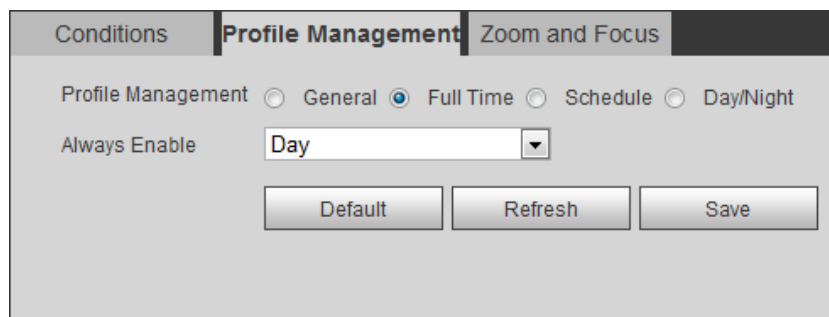

- When **Profile Management** is set as **Schedule**, you can drag the slide block to set certain time as **Day** or **Night**. For example, set 8:00–18:00 as day, and 0:00–8:00 and 18:00–24:00 as night.

Figure 4-45 Schedule

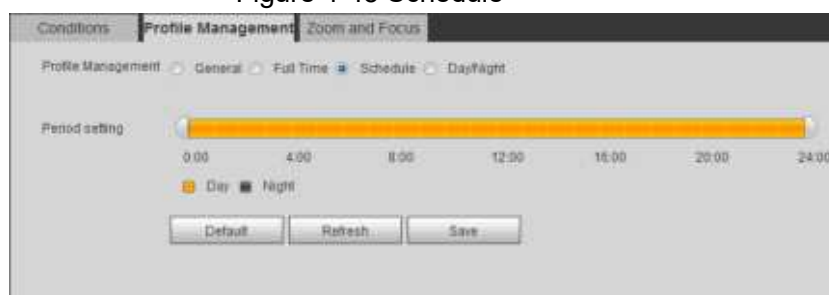

- When **Profile Management** is set as **Day & Night**, the surveillance system works under **Day & Night** configuration.

Figure 4-46 Day/Night

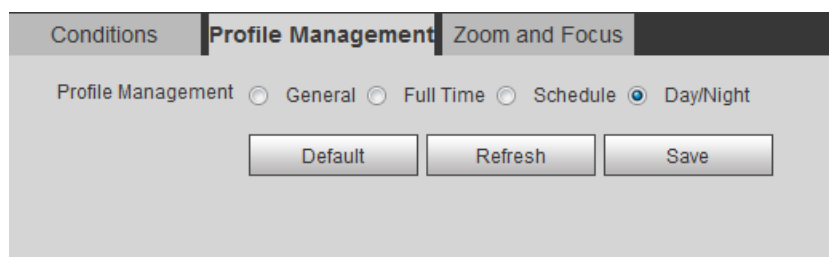

Step 3 Click **Save**.

4.5.1.3 Zoom and Focus

You can adjust image clarity through auto or manual focus; and adjust the image size through zoom. For details, see 4.2.4.2 Zoom and Focus."

4.5.2 Setting Video Parameters

This section introduces video parameters, such as video, snapshot, overlay, ROI (region of interest), and path.



Click **Default**, and the device is restored to default configuration. Click **Refresh** to view the latest configuration.

4.5.2.1 Video

Configure video stream parameters, such as stream type, encode mode, resolution, frame rate, bit rate type, bit rate, I frame interval, SVC, and watermark.

Step 1 Select **Setting > Camera > Video > Video**.

The **Video** interface is displayed. See Figure 4-47.

Figure 4-47 Video

The screenshot shows the 'Video' configuration interface with the following settings:



Section	Parameter	Value
Main Stream	Encode Mode	H.264H
	Smart Codec	Off
	Resolution	4000*3000(4000x3000)
	Frame Rate(FPS)	30
	Bit Rate Type	CBR
	Reference Bit Rate	7726-16384(Kb/s)
	Bit Rate	Customized
		8448 (3-17664) (Kb/s)
	I Frame Interval	60 (30-150)
	SVC	2
Sub Stream	<input checked="" type="checkbox"/> Enable	Sub Stream1
	Encode Mode	H.264H
	Resolution	704*480(D1)
	Frame Rate(FPS)	30
	Bit Rate Type	CBR
	Reference Bit Rate	512-2048(Kb/s)
	Bit Rate	768 (Kb/s)
I Frame Interval	60 (30-150)	
SVC	1(off)	
Watermark Settings		<input checked="" type="checkbox"/>
Watermark Character		DigitalCCTV

Buttons at the bottom: Default, Refresh, Save

Step 2 Configure video parameters. For details, see Table 4-17.

Table 4-17 Description of video parameters

Parameter	Description
Enable	<p>Select the Enable check box to enable sub stream, it is enabled by default.</p>  <p>You can enable multiple sub streams simultaneously.</p>
Encode Mode	<p>Select encode mode.</p> <ul style="list-style-type: none"> ● H.264: Main profile encode mode. Compared with H.264B, it requires smaller bandwidth. ● H.264H: High profile encode mode. Compared with H.264, it requires smaller bandwidth. ● H.264B: Baseline profile encode mode. It requires smaller bandwidth. ● H.265: Main profile encode mode. Compared with H.264, it requires smaller bandwidth. ● MJPEG: When under this mode, the image requires high bit rate value to ensure clarity, you are recommended to set the Bit Rate value to the biggest value in the Reference Bit Rate.

Parameter	Description
Smart Codec	<p>Enable smart codec to improve video compressibility and save storage space.</p>  <p>After smart codec is enabled, the device would stop supporting the third bit stream, ROI, and smart event detection, and the actual interface shall prevail.</p>
Resolution	The resolution of the video. The higher the value is, the clearer the image will be, but the bigger the bandwidth will be required.
Video Clip	<p>This function is available only for sub stream 2 of some select models.</p> <ol style="list-style-type: none"> 1. Select Video Clip, and click . The Area interface is displayed. 2. Select resolution as needed and clip image on the interface. 3. View the clipped video on Live interface (the live interface of sub stream 2 only displays the clipped area).
Frame Rate (FPS)	The number of frame in one second of video. The higher the value is, the clearer and smoother the video will be.
Bit Rate Type	<p>The bit rate control type during video data transmission. You can select bit rate type from:</p> <ul style="list-style-type: none"> ● CBR (Constant Bit Rate): The bit rate changes a little and keeps close to the defined bit rate value. ● VBR (Variable Bit Rate): The bit rate changes as monitoring scene changes.  <p>The Bit Rate Type can be only be set as CBR when Encode Mode is set as MJPEG.</p>
Quality	<p>This parameter can be configured only when the Bit Rate Type is set as VBR.</p> <p>The better the quality is, the larger the bandwidth will be requested.</p>
Reference Bit Rate	The most suitable bit rate value range recommended to user according to the defined resolution and frame rate.
Max Bit Rate	<p>This parameter can be configured only when the Bit Rate Type is set as VBR.</p> <p>You can select the value of the Max Bit Rate according to the Reference Bit Rate value. The bit rate then changes as monitoring scene changes, but the max bit rate keeps close to the defined value.</p>
Bit Rate	<p>This parameter can be configured only when the Bit Rate Type is set as CBR.</p> <p>Select bit rate value in the list according to actual condition.</p>
I Frame Interval	<p>The number of P frames between two I frames, and the I Frame Interval range changes as FPS changes.</p> <p>It is recommended to set I Frame Interval twice as big as FPS.</p>

Parameter	Description
SVC	<p>Scaled video coding, able to encode a high quality video bit stream that contains one or more subset bit streams. When sending stream, to improve inflency, the system will quit some data of related lays acoording to the network staus.</p> <ul style="list-style-type: none"> 1: The default value, which means that there is no layered coding. 2, 3 and 4: The lay number that the video stream is packed.
Watermark Settings	<p>You can verify the watermark to check if the video has been tampered.</p> <ol style="list-style-type: none"> Select the check box to enable watermark function.
Watermark Character	<ol style="list-style-type: none"> The default character is DigitalCCTV.

Step 3 Click **Save**.

4.5.2.2 Snapshot

You can configure snapshot parameters, including snapshot type, image size, quality and interval.

Step 1 Select **Setting > Camera > Video > Snapshot**.

The **Snapshot** interface is displayed, see Figure 4-48.

Figure 4-48 Snapshot

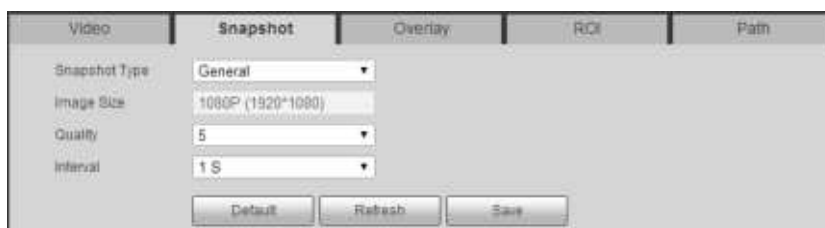

Step 2 Configure snapshot parameters. For details, see Table 4-18.

Table 4-18 Description of snapshot parameter

Parameter	Description
Snapshot Type	<p>You can select General and Event.</p> <ul style="list-style-type: none"> General: The system takes snapshot as scheduled. For details, see "4.7.2 Setting Schedule." Event: The system takes snapshot when the video detection, audio detection, event, or alarm is triggered. This function requires the corresponding snapshot being enabled.
Image Size	The same resolution with main stream.
Quality	Configures the snapshot quality. There are six levels of Image quality, and the sixth is the best.
Interval	<p>Configures the snapshot frequency.</p> <p>Select Customized, and then you can configure snapshot frequency manually.</p>

Step 3 Click **Save**.

4.5.2.3 Overlay

Configure overlay information, and it will be displayed on the **Live** interface.

4.5.2.3.1 Configuring Privacy Masking

You can enable this function when you need to protect privacy of some area on the video image.

Step 1 Select **Setting > Camera > Video > Overlay > Privacy Masking**.

The **Privacy Masking** interface is displayed. See Figure 4-49 and Figure 4-50.

Figure 4-49 Privacy masking

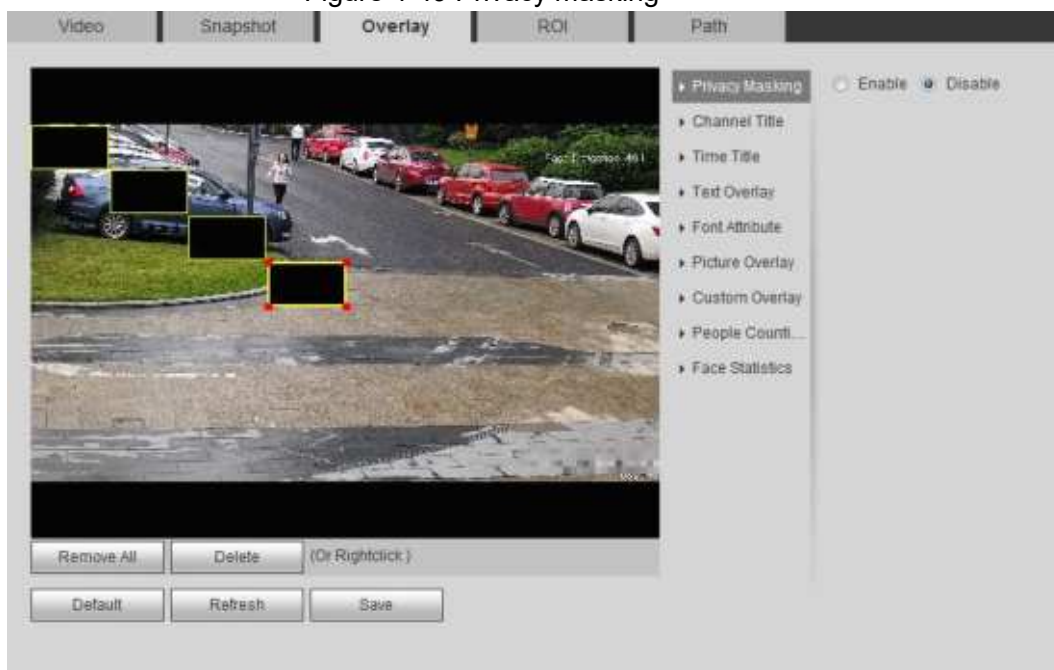
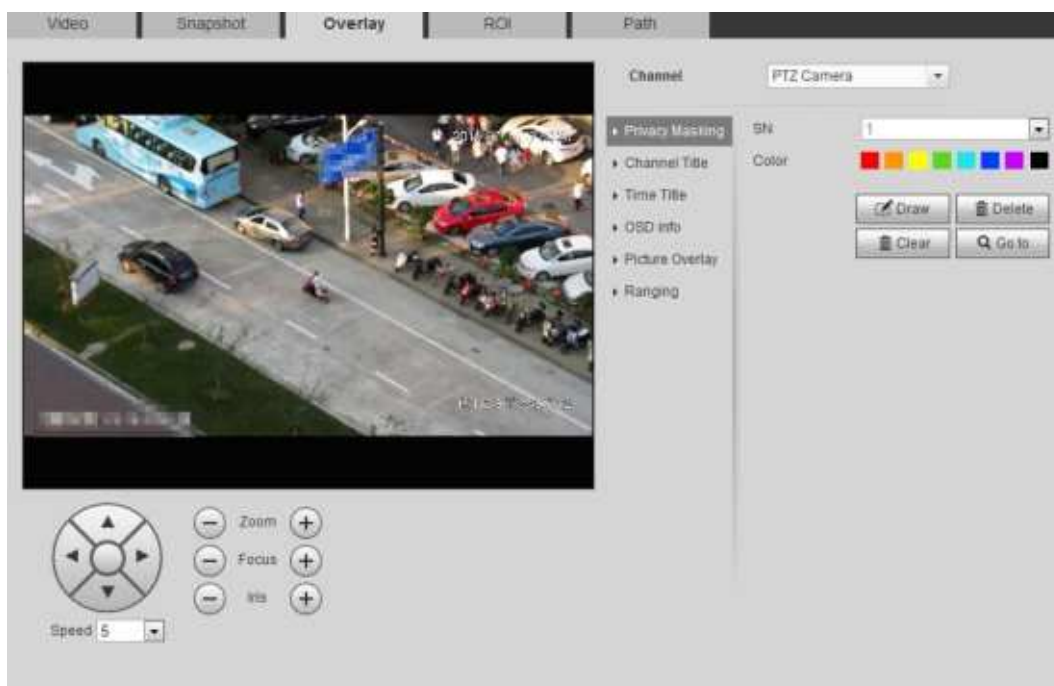

Figure 4-50 Privacy masking (speed dome)



Step 2 Configure privacy masking.

- Speed Dome
 - 1) Select the SN.
 - 2) Adjust the live image to the proper location through PTZ, select the color, and then click **Draw**. Press the mouse button to draw rectangles. The configuration takes effect immediately.

Other operations:

- ◇ Select the SN, and click **Go to**, the speed dome rotates to the masked area.
- ◇ Select the SN, and click **Delete** to delete the masking rectangles.
- ◇ Click **Clear**, and the click **OK** to clear all masking rectangles.
- Other cameras
 - 1) Select the **Enable** check box, and then drag the block to the area that you need to cover.



- You can drag four rectangles at most.
 - Click Remove All to delete all the area boxes; select one box, and then click Delete or right-click to delete it.
- 2) Adjust the size of the rectangle to protect the privacy.
 - 3) Click **Save**.

4.5.2.3.2 Configuring Channel Title

You can enable this function when you need to display channel title in the video image.

Step 1 Select **Setting > Camera > Video > Overlay > Channel Title**.

The **Channel Title** interface is displayed. See Figure 4-51.

Figure 4-51 Channel title

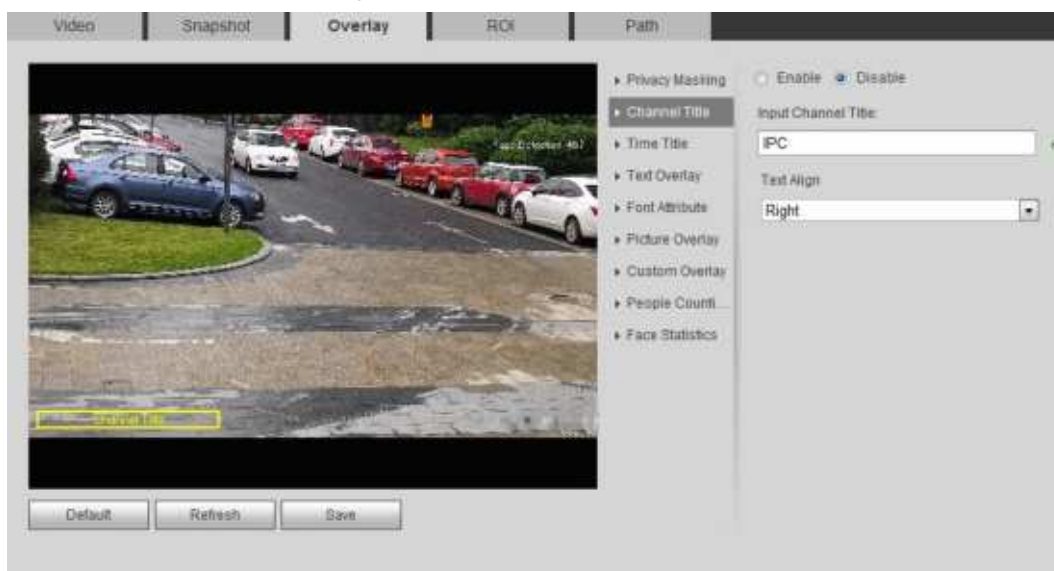

Step 2 Select the **Enable** check box, enter the channel title, and select the text align.



Click **+** to expand the channel title, and you can expand 1 line at most.

Step 3 Move the title box to the position that you want in the image.

Step 4 Click **Save**.

4.5.2.3.3 Configuring Time Title

You can enable this function when you need to display time in the video image.

Step 1 Select **Setting > Camera > Video > Overlay > Time Title**.

The **Time Title** interface is displayed. See Figure 4-52.

Figure 4-52 Time title

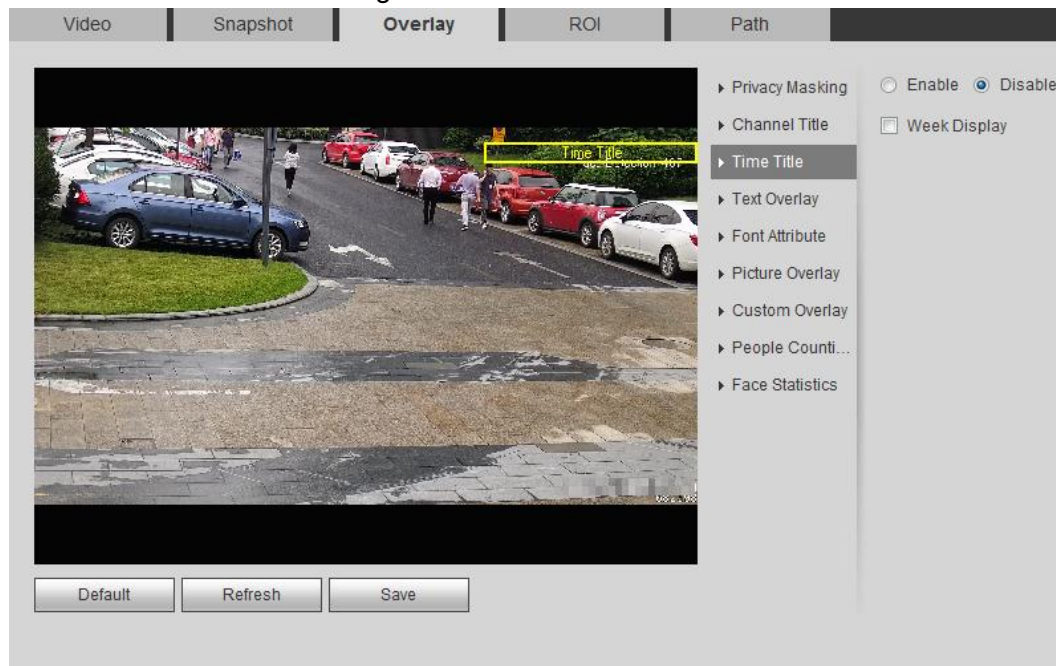

Step 2 Select the **Enable** check box.

Step 3 Select the **Week Display** check box.

Step 4 Move the time box to the position you want in the image.

Step 5 Click **Save**.

4.5.2.3.4 Configure Text Overlay

You can enable this function if you need to display text in the video image.



Text overlay and picture overlay cannot work at the same time, and the IPC that connects to mobile NVR with private protocol would display GPS information as priority.

Step 1 Select **Setting > Camera > Video > Overlay > Text Overlay**.

The **Text Overlay** interface is displayed. See Figure 4-53.

Figure 4-53 Text overlay

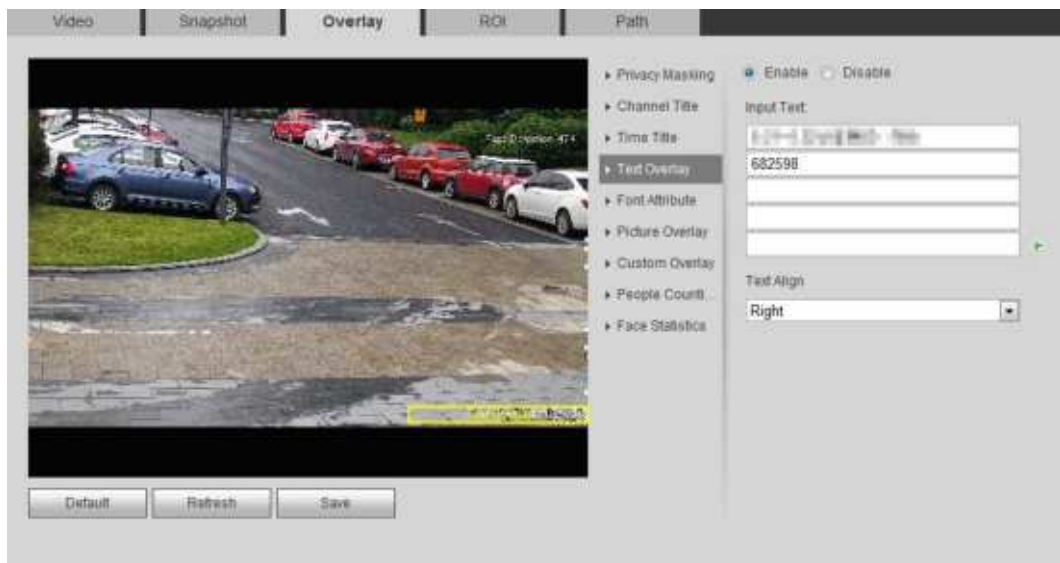

Step 2 Select the **Enable** check box, enter the text you need, and then select alignment. The text is displayed in the video image.



Click **+** to expand the text overlay, and you can expand 9 lines at most.

Step 3 Move the text box to the position you want in the image.

Step 4 Click **Save**.

4.5.2.3.5 Configure Font Attribute

You can enable this function if you need to adjust the font size in the video image.

Step 1 Select **Setting > Camera > Video > Overlay > Font Attribute**.

The **Font Attribute** interface is displayed. See Figure 4-54.

Figure 4-54 Font attribute



Step 2 Select the font color and size.

Click **More Color** to customize the font color.

Step 3 Click **Save**.

4.5.2.3.6 Configure Picture Overlay

You can enable this function if you need to display picture information on the video image.



Text overlay and picture overlay cannot work at the same time.

Step 1 Select **Setting > Camera > Video > Overlay > Picture Overlay**.

The **Picture Overlay** interface is displayed. See Figure 4-55.

Figure 4-55 Picture overlay

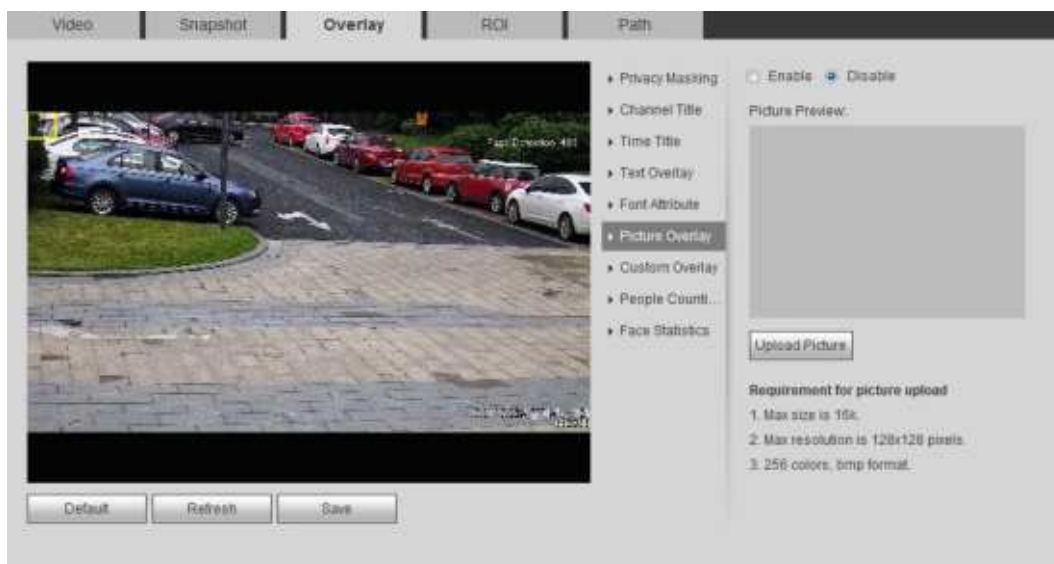

Step 2 Select the **Enable** check box, click **Upload Picture**, and then select the picture to be overlaid.

The picture is displayed on the video image.

Step 3 Move the overlaid picture to the position you want in the image.

Step 4 Click **Save**.

4.5.2.3.7 Configure Custom Overlay

You can enable this function if you need to display custom information on the video image.

Step 1 Select **Setting > Camera > Video > Overlay > Custom Overlay**.

The **Custom Overlay** interface is displayed. See Figure 4-56.

Figure 4-56 Custom overlay

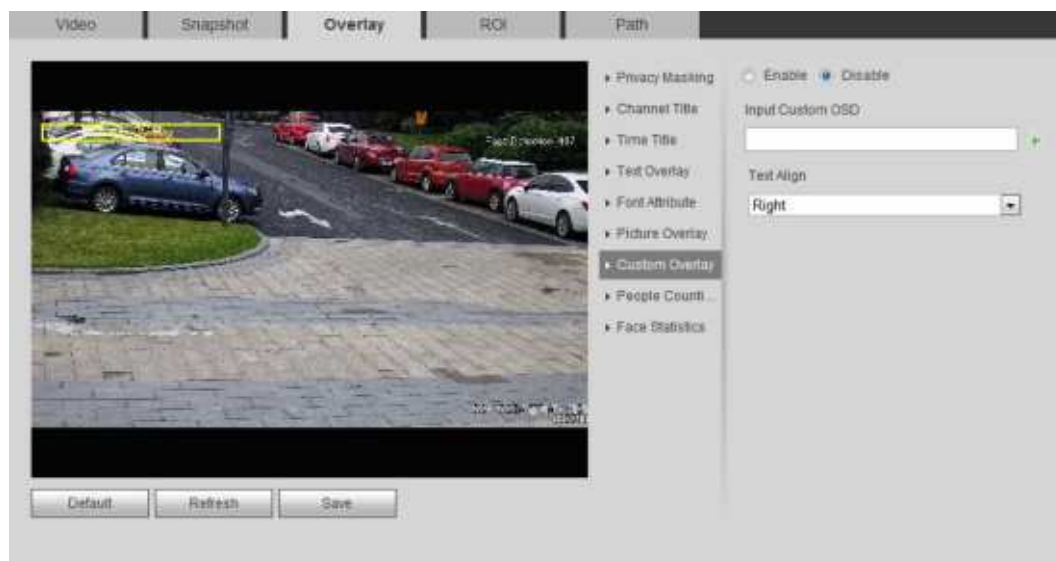

Step 2 Select the **Enable** check box, and then select the text align.



Click **+** to expand the custom overlay, and you can expand 1 line at most.

Step 3 Move the custom box to the position you want in the image.

Step 4 Click **Save**.

4.5.2.3.8 Configuring OSD Info

You can enable this function if you want to display the information of preset, PTZ coordinates, zoom, tour and location on the video image.



Only tracking speed dome supports OSD info function.

Step 1 Select **Setting > Camera > Video > OSD Info**.

The **OSD Info** interface is displayed. See Figure 4-57.

Figure 4-57 OSD info

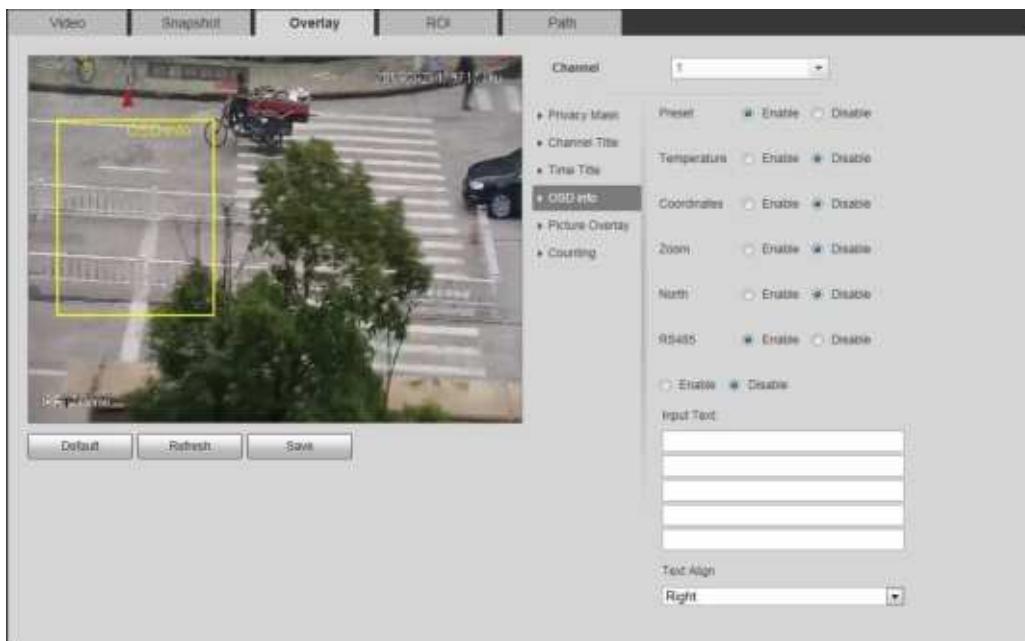

Step 2 Configure OSD information. See Table 4-19.

Table 4-19 Description of OSD information

Parameter	Description
Preset	Select Enable , and the preset name is displayed in the image when the camera turns to the preset, and it will disappear 3 s later.
Temperature	Select Enable and the internal temperature of the current device is displayed.
Coordinates	Select Enable and the PTZ coordinates info is displayed in the image.
Zoom	Select Enable and the zoom info is displayed in the image. such as  , which means 12x zoom rate.
North	Select Enable and the north direction is displayed in the image.
RS485	Select Enable and it will enable RS-485 communication function.
Text	Select Enable and set text, and the text is displayed in the image.
Input Text	
Text Align	Alignment mode of the displayed information in the image.

Step 3 Move the OSD box to the position you want in the image.

Step 4 Click **Save**.

4.5.2.3.9 Configuring Counting

The image displays statistics of the enter number and leave number. When the overlay function is enabled during intelligent rules configuration, this function is enabled simultaneously.

Step 1 Select **Setting > Camera > Video > Overlay > Counting**.

The **Counting** interface is displayed. See Figure 4-58.

Figure 4-58 Counting

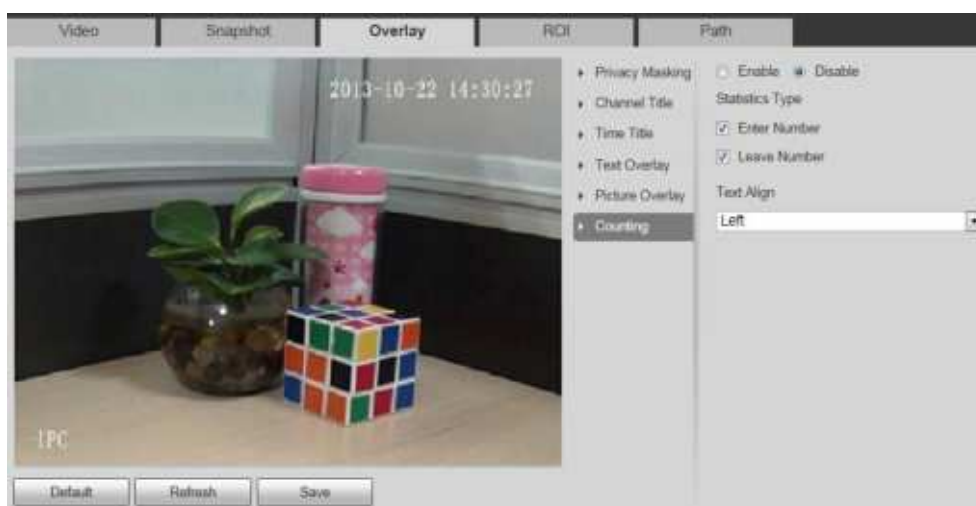

Step 2 Select the **Enable** check box, and then configure counting method and alignment.

Step 3 Move the counting box to the position you want in the image.

Step 4 Click **Save**.

4.5.2.3.10 Configuring Structured Statistics

The image displays structured statistics. When the overlay function enabled during intelligent rules configuration, this function is enabled simultaneously.

Step 1 Select **Setting > Camera > Video > Overlay > Structured Statistics**.

The **Structured Statistics** interface is displayed. See Figure 4-59.

Figure 4-59 Structured statistics

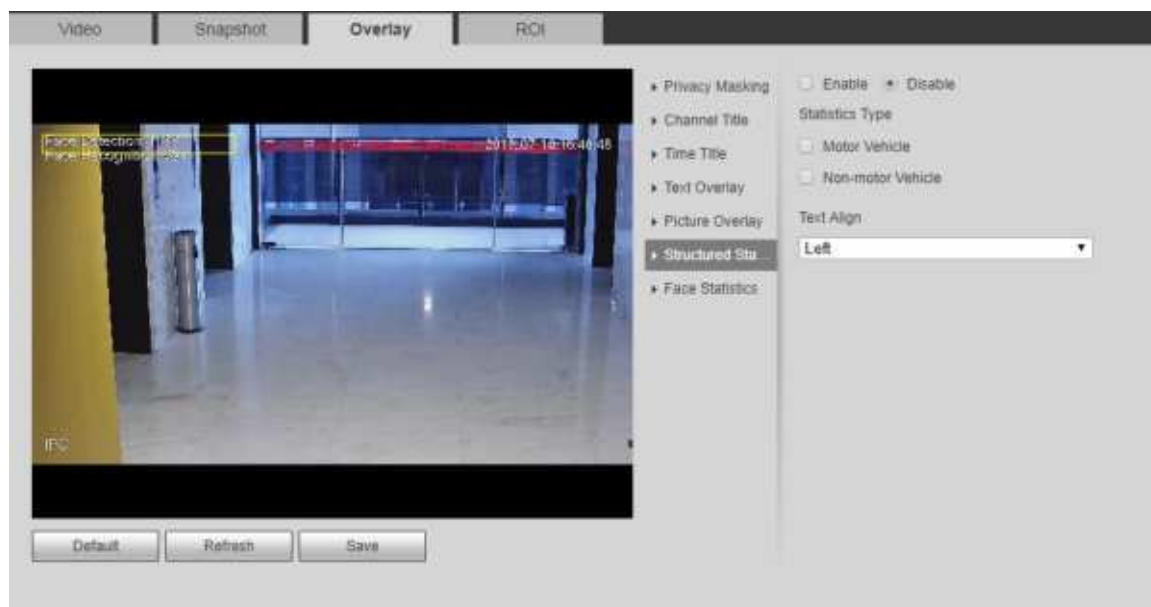

Step 2 Select the **Enable** check box, select the statistics type, and then select text align.

Step 3 Move the structured statistics box to the position you want in the image.

Step 4 Click **Save**.

4.5.2.3.11 Configuring Ranging

Configure camera height and the display time of overlay information. Click any point on the ground that the pole is installed on the image, and the overlay information between camera and the selected point is displayed.

Step 1 Select **Setting > Camera > Video > Overlay > Ranging**.

The **Ranging** interface is displayed. See Figure 4-60.

Figure 4-60 Ranging

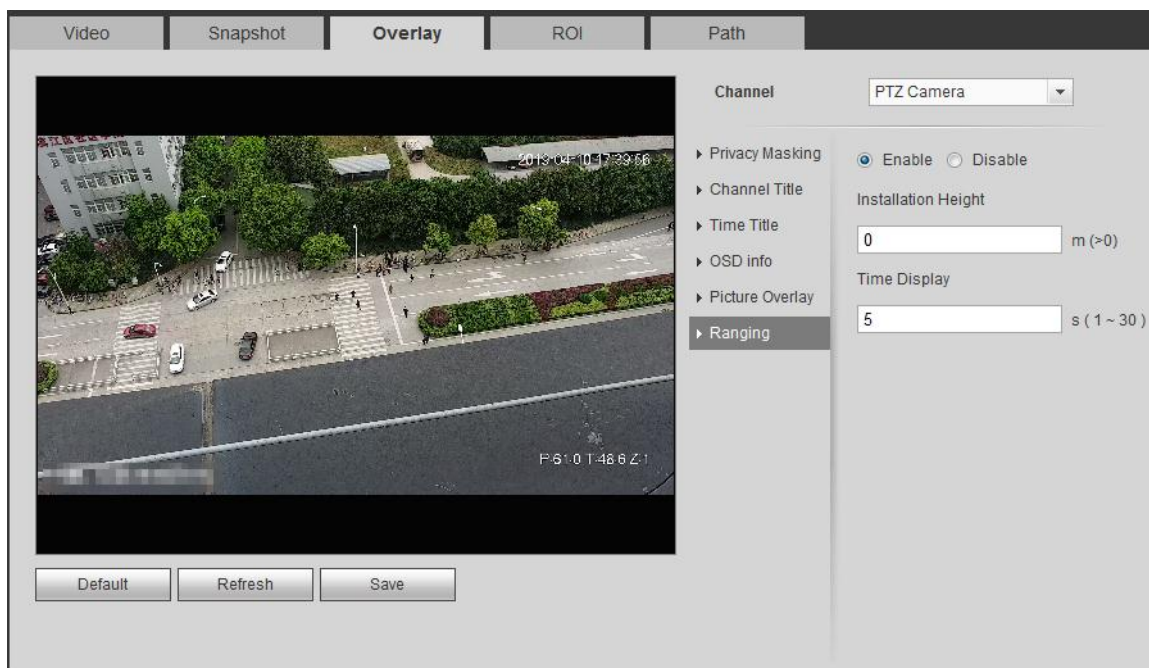

Step 2 Select the **Enable** check box, and then set the installation height and time display.

Time display: The display time of the ranging information on live image.

Step 3 Click **Save**.

4.5.2.3.12 Configuring ANPR

The image displays ANPR statistics information. When the overlay function enabled during intelligent rules configuration, this function is enabled simultaneously.

Step 1 Select **Setting > Camera > Video > Overlay > ANPR**.

The **ANPR** interface is displayed. See Figure 4-61.

Figure 4-61 ANPR

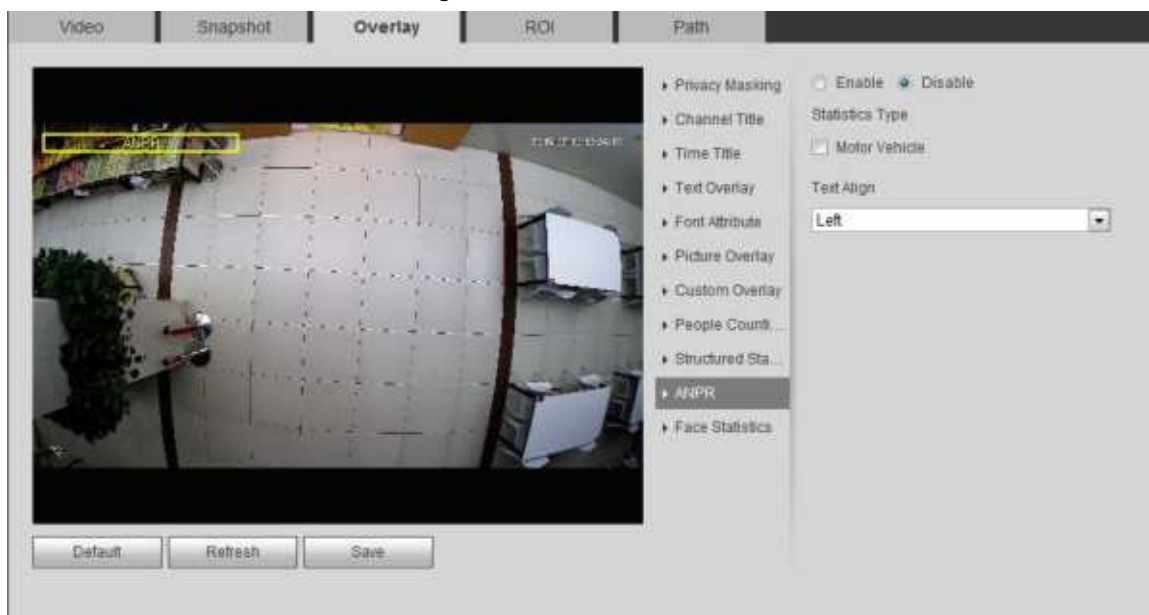

Step 2 Select the **Enable** check box, select the statistics type, and then select text align.

Step 3 Move the ANPR box to the position you want in the image.

Step 4 Click **Save**.

4.5.2.3.13 Configuring Face Statistics

The image displays face statistics information. When the overlay function enabled during intelligent rules configuration, this function is enabled simultaneously.

Step 1 Select **Setting > Camera > Video > Overlay > Face Statistics**.

The **Face Statistics** interface is displayed. See Figure 4-62.

Figure 4-62 Face statistics

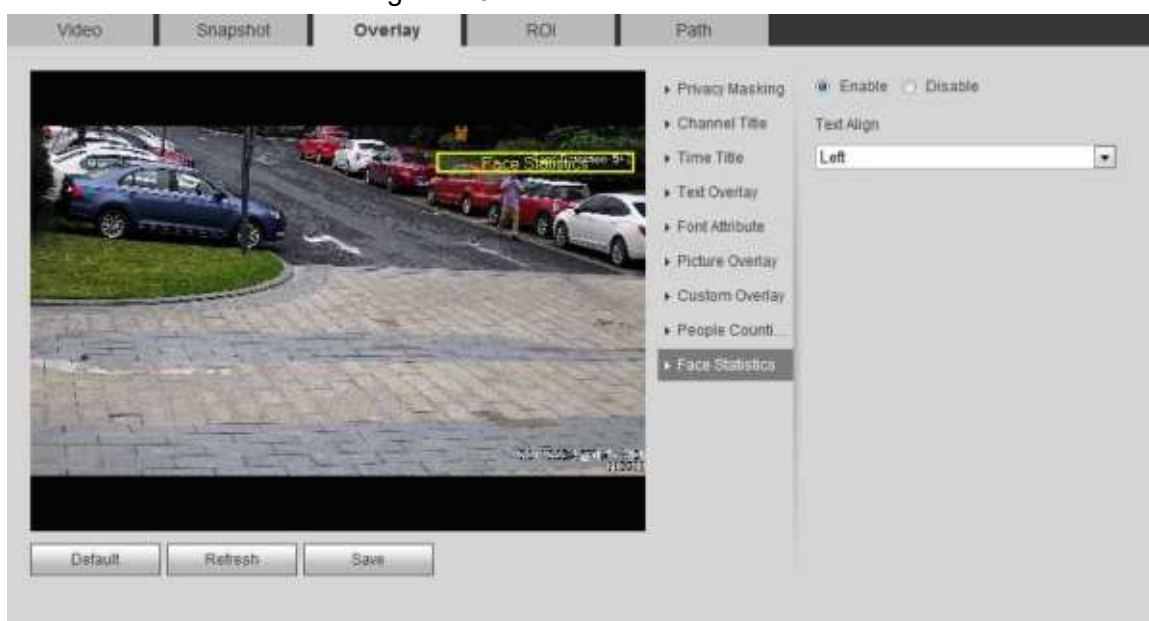

Step 2 Select the **Enable** check box, and select the text align.

Step 3 Move the structured statistics box to the position you want in the image.

Step 4 Click **Save**.

4.5.2.4 ROI

Select ROI (region of interest) on the image and configure the image quality of ROI, and then the selected image is display at defined quality.

Step 1 Select **Setting > Camera > Video > ROI**.

The **ROI** interface is displayed. See Figure 4-63.

Figure 4-63 ROI

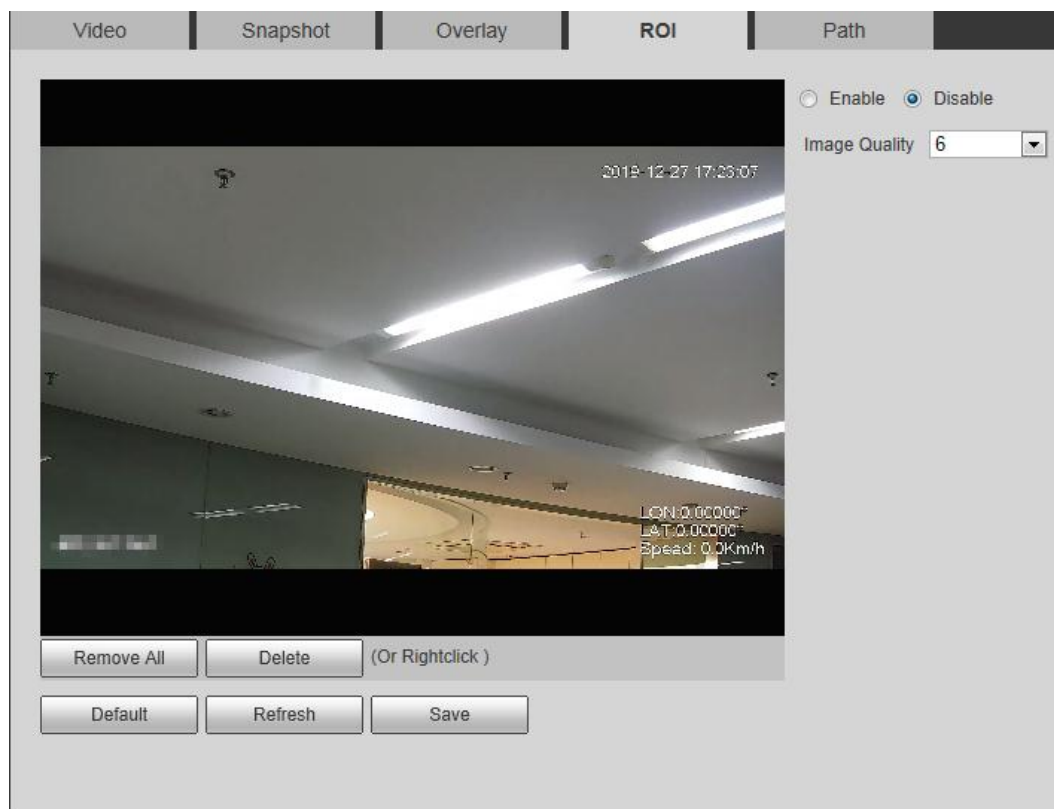

Step 2 Select the **Enable** check box, draw the area on the image, and then configure the image quality of ROI.



- You can draw four area boxes at most.
- The higher the image quality value is, the better the quality will be.
- Click **Remove All** to delete all the area boxes; select one box, and then click **Delete** or right-click to delete it.

Step 3 Click **Save**.

4.5.2.5 Path

You can configure the storage path for live snapshot, live record, playback snapshot, playback download, and video clips.

Step 1 Select **Setting > Camera > Video > Path**.

The **Path** interface is displayed. See Figure 4-64.

Figure 4-64 Path

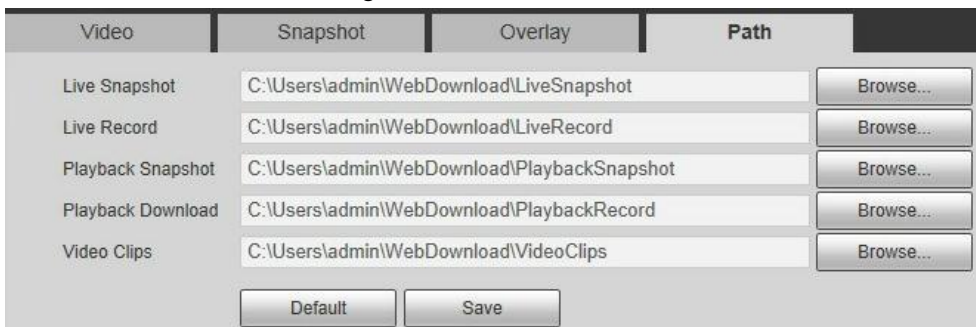

Step 2 Click **Browse** to select the storage path for live snapshot, live record, playback snapshot, playback download, and video clips. For details, see Table 4-20.

Table 4-20 Description of path

Parameter	Description
Live Snapshot	The snapshot of live interface. The default path is C:\Users\admin\WebDownload\LiveSnapshot.
Live Record	The recorded video of live interface. The default path is C:\Users\admin\WebDownload\LiveRecord.
Playback Snapshot	The snapshot of playback interface. The default path is C:\Users\admin\WebDownload\PlaybackSnapshot.
Playback Download	The downloaded video of playback interface. The default path is C:\Users\admin\WebDownload\PlaybackRecord.
Video Clips	The clipped video of playback interface. The default path is C:\Users\admin\WebDownload\VideoClips.



Admin in the path refers to the account being used.

Step 3 Click **Save**.

4.5.3 Audio

You can configure audio parameters and alarm audio.

4.5.3.1 Configuring Audio Parameter

This section introduces audio parameters, including encode mode, sampling frequency, audio in type, and noise filter.

Step 1 Select **Setting > Camera > Audio > Audio**.

The **Audio** interface is displayed. See Figure 4-65.

Figure 4-65 Audio

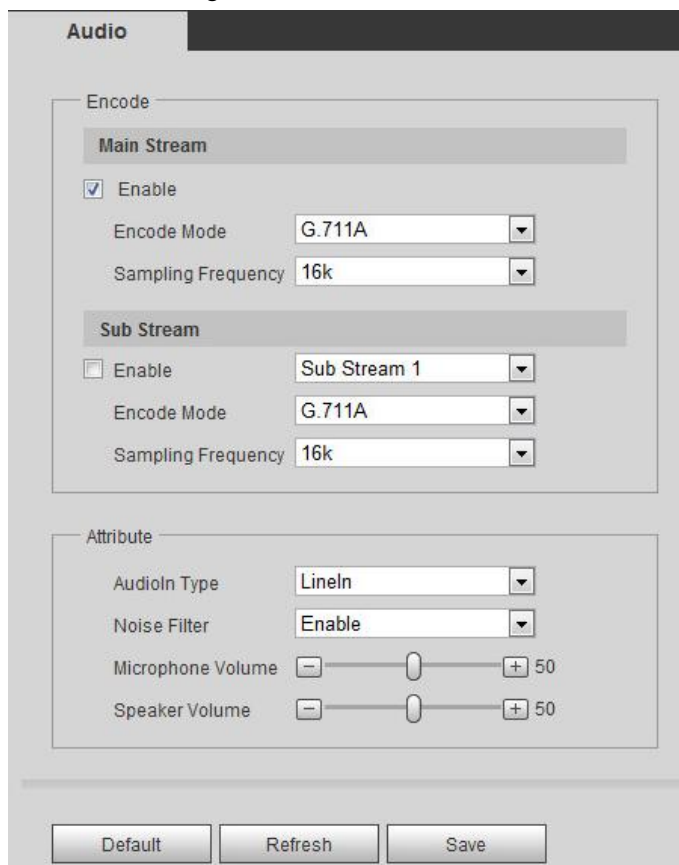

- Step 2** Select the **Enable** check box in **Main Stream** or **Sub Stream**.
 For the camera with multiple channels, select the channel number.
- Step 3** Configure audio parameters. For details, see Table 4-21.



Table 4-21 Description of audio parameters

Parameter	Description
Encode Mode	You can select audio Encode Mode from G.711A , G.711Mu , AAC , G.726 . The configured audio encode mode applies to both audio and intercom. The default value is recommended.
Sampling Frequency	Sampling number per second. The higher the sampling frequency is, the more the sample in a second will be, and the more accuracy the restored signal will be. You can select audio Sampling Frequency from 8K , 16K , 32K , 48K , 64K .
Audioin Type	You can select audioin type from: <ul style="list-style-type: none"> • Linein: Requires external audio device. • Mic: Not require external audio device.
Noise Filter	Enable this function, and the system auto filters ambient noise.
Microphone Volume	Adjusts microphone volume.
Speaker Volume	Adjusts speaker volume.

- Step 4** Click **Save**.

4.5.3.2 Configuring Alarm Audio

You can record or upload alarm audio file. The audio file will be played when the alarm is triggered.

- Click  to play the selected audio.
- Click  to download the audio to local storage.

Step 1 Select **Setting > Camera > Audio > Alarm Audio**.

The **Alarm Audio** interface is displayed. See Figure 4-66.

Figure 4-66 Alarm audio



Step 2 Click **Add Audio File**.

The **Add Audio File** dialog box is displayed. See Figure 4-67.

Figure 4-67 Add audio file

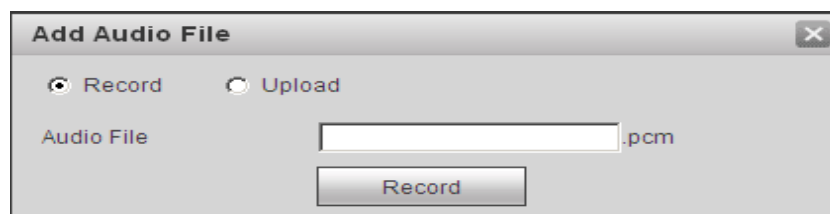

Step 3 Configure the audio file.

- Select **Record**, enter the audio name in the input box, and then click **Record**.
- Select **Upload**, click  to select the audio file to be uploaded, and then click **Upload**.



The camera supports audio file with .pcm format only, and you can upload audio files with .pcm or .wav2 formats.

Step 4 Select the file you need.

4.6 Network

This section introduces network configuration.

4.6.1 TCP/IP

You can configure IP address and DNS (Domain Name System) server and so on according to network planning.

Preparation

The camera has connected to the network.

Procedure

Step 1 Select **Setting > Network > TCP/IP**.

The **TCP/IP** interface is displayed. See Figure 4-68.

Figure 4-68 TCP/IP

Step 2 Configure TCP/IP parameters. For details, see Table 4-22.

Table 4-22 Description of TCP/IP parameters

Parameter	Description
Host Name	Enter the host name, and the maximum length is 15 characters.
Ethernet Card	Select the Ethernet card that need to be configured, and the default one is Wire .
Mode	The mode that the camera gets IP: <ul style="list-style-type: none"> • Static Configure IP Address, Subnet Mask, and Default Gateway manually, and then click Save, the login interface with the configured IP address is displayed. • DHCP When there is DHCP server in the network, select DHCP, and the camera acquires IP address automatically.

Parameter	Description
MAC Address	Displays host MAC address.
IP Version	Select IPv4 or IPv6 .
IP Address	When you select Static in Mode , enter the IP address and subnet mask that you need.
Subnet Mask	
Default Gateway	<ul style="list-style-type: none"> IPv6 does not have subnet mask. The default gateway must be in the same network segment with the IP address.
Preferred DNS	IP address of the preferred DNS
Alternate DNS	IP address of the alternate DNS
Enable ARP/Ping to set IP address service	<p>Select the check box, get the camera MAC address, and then you can modify and configure the device IP address with ARP/ping command. This is enabled by default. During reboot, you will have no more than 2 minutes to configure the device IP address by a ping packet with certain length, the server will be turned off in 2 minutes, or it will be turned off immediately after the IP address is successfully configured. If this is not enabled, the IP address cannot be configured with ping packet.</p> <p>A demonstration of configuring IP address with ARP/Ping.</p> <ol style="list-style-type: none"> Keep the camera that needs to be configured and the PC within the same local network, and then get a usable IP address. Get the MAC address of the camera from device label. Open command editor on the PC and enter the following command. <div data-bbox="596 1296 1259 1854" data-label="Code-Block"> <pre>Windows syntax␣ arp -s <IP Address> <MAC> ␣ ping -l 480 -t <IP Address> ␣ Windows example␣ arp -s 192.168.0.125 11-40-8c-18-10-11␣ ping -l 480 -t 192.168.0.125␣ UNIX/Linux/Mac syntax␣ arp -s <IP Address> <MAC> ␣ ping -s 480 <IP Address> ␣ UNIX/Linux/Mac example␣ arp -s 192.168.0.125 11-40-8c-18-10-11␣ ping -s 480 192.168.0.125␣</pre> </div> Reboot camera. Check the PC command line, if information such as Reply from 192.168.0.125... is displayed, the configuration succeeds, and you can turn it off then. Enter <code>http://(IP address)</code> in the browser address bar to log in.

Step 3 Click **Save**.

4.6.2 Port

Configure the port numbers and the maximum number of users (includes web, platform client, and mobile phone client) that can connect to the device simultaneously.

Step 1 Select **Setting > Network > Port**.

The **Port** interface is displayed. See Figure 4-69.

Figure 4-69 Port

Parameter	Value	Range
Max Connection	10	(1~20)
TCP Port	3777	(1025~65534)
UDP Port	3778	(1025~65534)
HTTP Port	80	
RTSP Port	554	
RTMP Port	1935	(1025~65534)
HTTPS Port	443	

Buttons: Default, Refresh, Save

Step 2 Configure port parameters. For details, see Table 4-23.



- 0–1024, 1900, 3800, 5000, 5050, 9999, 37776, 37780–37880, 39999, 42323 are occupied for specific uses.
- Do not use the same value of any other port during port configuration.

Table 4-23 Description of port parameters

Parameter	Description
Max Connection	The max number of users (web client, platform client or mobile phone client) that can connect to the device simultaneously. The value is 10 by default.
TCP Port	Transmission control protocol port. The value is 37777 by default.
UDP Port	User datagram protocol port. The value is 37778 by default.
HTTP Port	Hyper text transfer protocol port. The value is 80 by default.

Parameter	Description
RTSP Port	<ul style="list-style-type: none"> Real time streaming protocol port, and the value is 554 by default. If you play live view with QuickTime, VLC or Blackberry smart phone, the following URL format is available. When the URL format requiring RTSP, you need to specify channel number and bit stream type in the URL, and also user name and password if needed. When playing live view with Blackberry smart phone, you need to turn off the audio, and then set the codec mode to H.264B and resolution to CIF. <p>URL format example: rtsp://username:password@ip:port/cam/realmonitor?channel=1&subtype=0</p> <p>Among that:</p> <ul style="list-style-type: none"> Username: The user name, such as admin. Password: The password, such as admin. IP: The device IP, such as 192.168.1.112. Port: Leave it if the value is 554 by default. Channel: The channel number, which starts from 1. For example, if you are using channel 2, then the channel=2. Subtype: The bit stream type; 0 means main stream (Subtype=0) and 1 means sub stream (Subtype=1). <p>Example: If you require the sub stream of channel 2 from a certain device, then the URL should be: rtsp://admin:admin@10.12.4.84:554/cam/realmonitor?channel=2&subtype=1</p> <p>If user name and password are not needed, then the URL can be: rtsp://ip:port/cam/realmonitor?channel=1&subtype=0</p>
RTMP Port	Real Time Messaging Protocol. The port that RTMP provides service. It is 1935 by default.
HTTPS Port	HTTPS communication port. It is 443 by default.

Step 3 Click **Save**.



The configuration of **Max Connection** takes effect immediately, and others will take effect after reboot.

4.6.3 PPPoE

Point-to-Point Protocol over Ethernet, it is one of the protocols that device uses to connect to the internet. Get the PPPoE user name and password from the internet service provider, and then set up network connection through PPPoE, the camera will acquire a WAN dynamic IP address.



- Disable UPnP while using PPPoE to avoid possible influence.
- After making PPPoE connection, the device IP address cannot be modified through web interface.

Preparation

- The camera has connected to the network.
- You have gotten the account and password from Internet Service Provider.

Procedure

Step 1 Select **Setting > Network > PPPoE**.

The **PPPoE** interface is displayed. See Figure 4-70.

Figure 4-70 PPPoE

Step 2 Select the **Enable** check box, and then enter user name and password.

Step 3 Click **Save**.

The success prompt box is displayed, and then the real-time WAN IP address is displayed. You can visit camera through the IP address.

4.6.4 DDNS

Properly configure DDNS, and then the domain name on the DNS server matches your IP address and the matching relation refreshes in real time. You can always visit the camera with the same domain name no matter how the IP address changes.



- Third party server might collect your device information after DDNS is enabled.
- Register and log in to the DDNS website, and then you can view the information of all the connected devices in your account.

Preparation

Check the type of DNS server supported by the camera.

Procedure

Step 1 Select **Setting > Network > DDNS**.

The **DDNS** interface is displayed. See Figure 4-71.

Figure 4-71 DDNS (1)

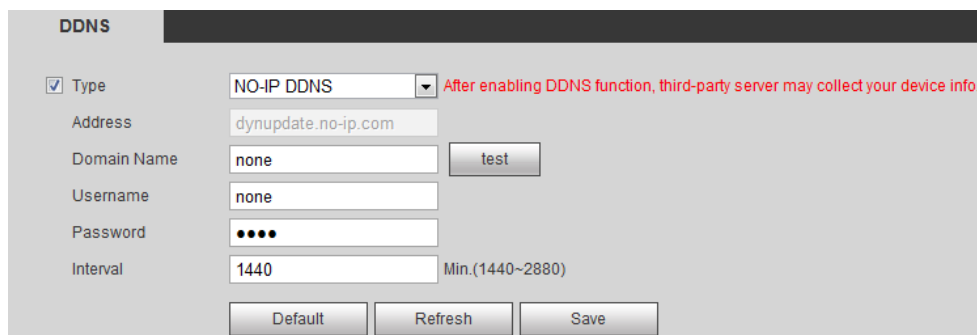

Step 2 Select **Type**, and configure the parameters as needed. For details, see Table 4-24.

Table 4-24 Description of DDNS parameters

Parameter	Description
Type	The name and web address of the DDNS service provider, see the matching relationship below:
Web Address	<ul style="list-style-type: none"> • CN99 DDNS web address: www.3322.org • NO-IP DDNS web address: dynamupdate.no-ip.com • DynDNS DDNS web address: members.dyndns.org
Domain Name	The domain name you registered on the DDNS website.
Test	Only when selecting NO-IP DDNS type, you can click test to check whether the domain name registration is successful.
Username	Enter the user name and password that you got from the DDNS server provider. You need to register an account (includes user name and password) on the DDNS server provider's website.
Password	
Interval	The update cycle of the connection between the device and the server, and the time is 10 minutes by default.

Step 3 Click **Save**.

Verification

Open the browser on PC, enter the domain name at the address bar, and then press Enter, the login interface is displayed.

4.6.5 SMTP (Email)

Configure email parameter and enable email linkage. The system sends email to the defined address when the corresponding alarm is triggered.

Step 1 Select **Setting > Network > SMTP (Email)**.

The **SMTP (Email)** interface is displayed. See Figure 4-72.

Figure 4-72 SMTP (Email)



Step 2 Configure SMTP (Email) parameters. For details, see Table 4-25.

Table 4-25 Description of SMTP (Email) parameters

Parameter	Description
SMTP Server	SMTP server address
Port	The port number of the SMTP server.
Username	The account of SMTP server.
Password	The password of SMTP server.
Anonymity	Select the check box, and the sender's information is not displayed in the email.
Sender	Sender's email address.
Authentication	Select Authentication from None , SSL and TLS . For details, see "Table 4-26."
Title	Enter maximum 63 characters in Chinese, English, and Arabic numerals. Click to select title type, including Name , Device ID , and Event Type , and you can set maximum 2 titles.
Attachment	Select the check box to support attachment in the email.
Mail Receiver	Receiver's email address. Supports 3 addresses at most.
Health Mail	The system sends test mail to check if the connection is successfully configured. Select Health Mail and configure the Update Period , and then the system sends test mail as the set interval.

For the configuration of major mailboxes, see Table 4-26.

Table 4-26 Description of major mailbox configuration

Mailbox	SMTP server	Authentication	Port	Description
QQ	smtp.qq.com	SSL	465	<ul style="list-style-type: none"> The authentication type cannot be None. You need to enable SMTP service in your mailbox. The authentication code is required, the QQ password or email password is not applicable.  <p>Authentication code: The code you receive when enabling SMTP service.</p>
		TLS	587	
163	smtp.163.com	SSL	465/994	<ul style="list-style-type: none"> You need to enable SMTP service in your mailbox. The authentication code is required; the email password is not applicable.  <p>Authentication code: the code you receive when enabling SMTP service.</p>
		TLS	25	
		none	25	
Sina	smtp.sina.com	SSL	465	Enable SMTP service in your mailbox.
		none	25	
126	smtp.126.com	none	25	Enable SMTP service in your mailbox.

Step 3 Click **Save**.

Step 4 Click **Test** to test whether the emails can be sent and received successfully.

4.6.6 UPnP

UPnP (Universal Plug and Play), a protocol that establishes mapping relation between local area and wide area networks. This function enables you to visit local area device through wide area IP address.

Preparation

- Make sure the UPnP service is installed in the system.
- Log in the router, and configure WAN IP address to set up internet connection.
- Enable UPnP in the router.
- Connect your device to the LAN port of the router.
- Select **Setting > Network > TCP/IP**, in **IP Address**, enter the local area IP address of the router or select **DHCP** and acquires IP address automatically.

Procedure

Step 1 Select **Setting > Network > UPnP**.

The **UPnP** interface is displayed. See Figure 4-73.

Figure 4-73 UPnP



Step 2 Select the **Enable** check box, and there are two mapping modes: **Custom** and **Default**.

- Select **Custom**, click  and then you can modify external port as needed.
- Select **Default**, and then the system finishes mapping with unoccupied port automatically, and you cannot modify mapping relation.

Step 3 Click **Save**.

Open web browser on PC, enter http:// wide area IP address: external port number, and then you can visit the local area device with corresponding port.

4.6.7 SNMP

SNMP (Simple Network Management Protocol), which can be used to enable software such as MIB Builder and MG-SOFT MIB Browser to connect to the camera and manage and monitor the camera.

Preparation

- Install SNMP monitoring and managing tools such as MIB Builder and MG-SOFT MIB Browser.
- Get the MIB file of the matched version from technical support.

Procedure

Step 1 Select **Setting > Network > SNMP**.

The **SNMP** interface is displayed. See Figure 4-74 and Figure 4-75.

Figure 4-74 SNMP (1)

The screenshot shows the SNMP configuration interface. It includes the following fields and options:

- Version:** Three radio buttons for v1, v2, and v3.
- SNMP Port:** A text input field containing '161' with a range '(1-65535)' to its right.
- Read Community:** An empty text input field.
- Write Community:** An empty text input field.
- Trap Address:** An empty text input field.
- Trap Port:** A text input field containing '162'.

At the bottom of the interface, there are buttons for 'Default', 'Refresh', and 'Save'.

Figure 4-75 SNMP (2)

The image shows a web-based configuration interface for SNMP. At the top, the title is "SNMP". Below it, there are three radio buttons for "Version": "v1", "v2", and "v3 (Recommen...)", with "v3" selected. Below the version selection are several input fields: "SNMP Port" (161), "Read Community" (empty), "Write Community" (empty), "Trap Address" (empty), and "Trap Port" (162). There are two sections for user configuration. The first section is for "Read-only Username" (public), with "Authentication Type" set to MD5 and "Encryption Type" set to CBC-DES. The second section is for "Read&write Userna..." (private), also with "Authentication Type" set to MD5 and "Encryption Type" set to CBC-DES. Red text next to the password fields indicates "The minimum pass phrase length is 8 characters". At the bottom, there are three buttons: "Default", "Refresh", and "Save".

Step 2 Select SNMP version to enable SNMP.

- Select **V1**, and the system can only process information of V1 version.
- Select **V2**, and the system can only process information of V2 version.
- Select **V3**, and then **V1** and **V2** become unavailable. You can configure user name, password and authentication type. It requires corresponding user name, password and authentication type to visit your device from the server.





Using **V1** and **V2** might cause data leakage, and **V3** is recommended.

In **Trap Address**, enter the IP address of the PC that has MIB Builder and MG-SOFT MIB Browser installed, and leave other parameters to the default.

Table 4-27 Description of SNMP parameters

Parameter	Description
SNMP Port	The listening port of the software agent in the device.
Read Community, Write Community	The read and write community string that the software agent supports.  You can enter number, letter, underline and dash to form the name.
Trap Address	The target address of the Trap information sent by the software agent in the device.
Trap Port	The target port of the Trap information sent by the software agent in the device.

Parameter	Description
Read-only Username	Set the read-only username accessing device, and it is public by default.  You can enter number, letter, and underline to form the name.
Read/Write Username	Set the read/write username access device, and it is public by default.  You can enter number, letter, and underline to form the name.
Authentication Type	You can select from MD5 and SHA . The default type is MD5 .
Authentication Password	It should be no less than 8 digits.
Encryption Type	The default is CBC-DES.
Encryption Password	It should be no less than 8 digits.

Step 3 Click **Save**.

Verification

View device configuration through MIB Builder or MG-SOFT MIB Browser.

Step 1 Run MIB Builder and MG-SOFT MIB Browser.

Step 2 Compile the two MIB files with MIB Builder.

Step 3 Load the generated modules with MG-SOFT MIB Browser.

Step 4 Enter the IP address of the device you need to manage in the MG-SOFT MIB Browser, and then select version to search.

Step 5 Unfold all the tree lists displayed in the MG-SOFT MIB Browser, and then you can view the configuration information, video channel amount, audio channel amount, and software version.



Use PC with Windows OS and disable SNMP Trap service. The MG-SOFT MIB Browser will display prompt when alarm is triggered.

4.6.8 Bonjour

Enable this function, and the OS and clients that support Bonjour would find the camera automatically. You can have quick visit to the camera with Safari browser.



Bonjour is enabled by default.

Procedure

Step 1 Select **Setting > Network > Bonjour**.

The **Bonjour** interface is displayed. See Figure 4-76.

Figure 4-76 Bonjour

Step 2 Select the **Enable** check box, and then configure server name.

Step 3 Click **Save**.

Verification

In the OS and clients that support Bonjour, follow the steps blow to visit the network camera with Safari browser.

Step 1 Click **Show All Bookmarks** in Safari.

Step 2 Enable **Bonjour**. The OS or client automatically detects the network cameras with Bonjour enabled in the LAN.

Step 3 Click the camera to visit the corresponding web interface.

4.6.9 Multicast

When multiple users are previewing the device video image simultaneously through network, it might fail due to limited bandwidth. You can solve this problem by setting up a multicast IP (224.0.1.0–238.255.255.255) for the camera and adopt the multicast protocol.

Procedure

Step 1 Select **Setting > Network > Multicast**.

The **Multicast** interface is displayed. See Figure 4-77.

Figure 4-77 Multicast

Step 2 Select the **Enable** check box, and enter IP address and port number. For details, see Table 4-28.

Table 4-28 Description of multicast parameters

Parameter	Description
Multicast Address	The multicast IP address of Main Stream/Sub Stream is 224.1.2.4 by default, and the range is 224.0.0.0–239.255.255.255.
Port	The multicast port of corresponding stream: Main Stream : 40000; Sub Stream1 : 40016; Sub Stream2 : 40032, and all the range is 1025–65500.

Step 3 Click **Save**.

Verification

In the **Live** interface, select **RTSP** in **Multicast**, and then you can view the video image with multicast protocol.

4.6.10 802.1x

Cameras can connect to LAN after passing 802.1x authentication.

Step 1 Select **Setting > Network > 802.1x**.

The **802.1x** interface is displayed. See Figure 4-78.

Figure 4-78 802.1x

Step 2 Select the **Enable** check box, and then configure parameters. For details, see Table 4-29.

Table 4-29 Description of 802.1x parameters

Parameter	Description
Authentication	PEAP (protected EAP protocol).
Username	The user name that was authenticated on the server.
Password	Corresponding password.

Step 3 Click **Save**.

4.6.11 QoS

You can solve problems such as network delay and congestion with this function. It helps to assure bandwidth, reduce transmission delay, packet loss rate, and delay jitter to improve experience.

0–63 means 64 degrees of priority; 0 for the lowest and 63 the highest.

Step 1 Select **Setting > Network > QoS**.

The **QoS** interface is displayed. See Figure 4-79.

Figure 4-79 QoS



Step 2 Configure QoS parameters. For details, see Table 4-30.

Table 4-30 Description of QoS parameters

Parameter	Description
Realtime Monitor	Configure the priority of the data packets that used for network surveillance. 0 for the lowest and 63 the highest.
Command	Configure the priority of the data packets that used for configure or checking.

Step 3 Click **Save**.

4.6.12 Access Platform

4.6.12.1 P2P

P2P is a private network traversal technology which enables user to manage devices easily without requiring DDNS, port mapping or transit server.

Scan the QR code with your smart phone, and then you can add and manage more devices on the mobile phone client.

Step 1 Select **Setting > Network > Access Platform > P2P**.

The **P2P** interface is displayed. See Figure 4-80.

Figure 4-80 P2P

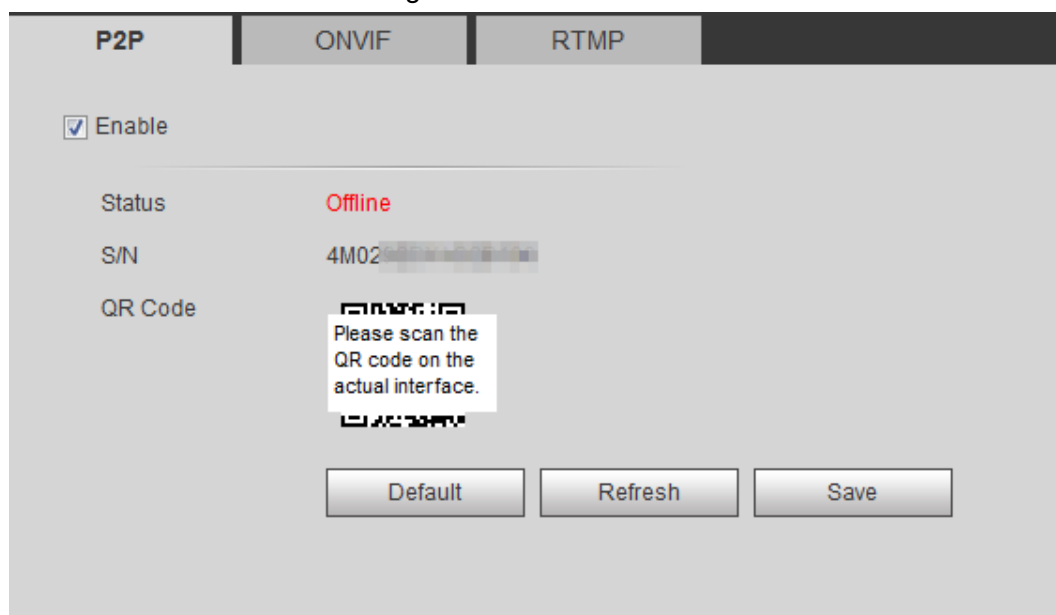

- When P2P is enabled, remote management on device is supported.
- When P2P is enabled and the device accesses to the network, the status shows online. The information of the IP address, MAC address, device name, and device SN will be collected. The collected information is for remote access only. You can cancel **Enable** selection to reject the collection.

Step 2 Log in to mobile phone client and tap **Device management**.

Step 3 Tap the **+** at the upper right corner.

Step 4 Scan the QR code on the **P2P** interface.

Step 5 Follow the instructions to finish the settings.

4.6.12.2 ONVIF

The ONVIF authentication is **On** by default, which allows the network video products (including video recording device and other recording devices) from other manufacturers to connect to your device.



ONVIF is enabled by default.

Step 1 Select **Setting > Network >Port > ONVIF**.

The **ONVIF** interface is displayed. See Figure 4-81.

Figure 4-81 ONVIF

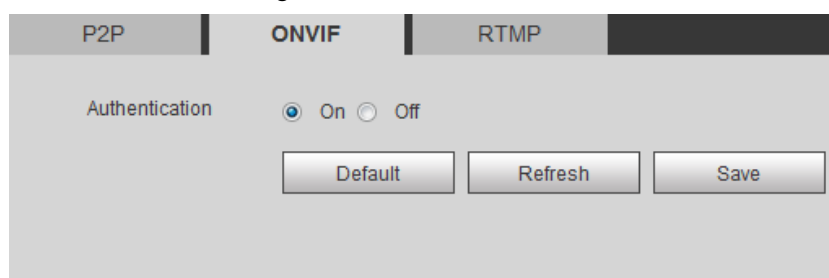

Step 2 Select **On** in **Authentication**.

Step 3 Click **Save**.

4.6.12.3 RTMP

Through RTMP, you can access the third-party platform (such as Ali and YouTube) to realize video live view.



- RTMP can be configured by admin only.
- RTMP supports the H.264, H.264 B and H.264H video formats, and the AAC audio format only.

Step 1 Select **Setting > Network >Port > RTMP**.

The **RTMP** interface is displayed. See Figure 4-82.

Figure 4-82 ONVIF

Step 2 Select the **Enable** check box.



Make sure that the IP address is trustable when enabling RTMP.

Step 3 Configure RTMP parameters. For details, see Table 4-31.

Table 4-31 Description of RTMP parameters

Parameter	Description
Stream Type	The stream for live view. Make sure that the video format is the H.264, H.264 B and H.264H, and the audio format is AAC.
Address Type	Includes Non-custom and Custom . <ul style="list-style-type: none"> ● Non-custom: Enter the server IP and domain name. ● Custom: Enter the path allocated by the server.
IP Address	When selecting Non-custom , you need to enter server IP address and port. <ul style="list-style-type: none"> ● IP address: Support IPv4 or domain name. ● Port: We recommend that you use the default one.
Port	
Custom Address	When selecting Custom , you need to enter the path allocated by the server.

Step 4 Click **Save**.

4.7 Storage

This section introduces how to manage saved resources (such as recorded video) and storage space. The storage management helps to make best use of storage space.

4.7.1 Setting Storage Plan

- Setting record plan and record control to achieve all-time recording, recording in specific period or alarm linked recording. For details, see "5.1.1.2.1 Setting Record Plan" and "5.1.1.2.2 Setting Record Control."
- Set the snapshot schedule as needed. "5.1.1.3.1 Setting Snapshot Plan."

4.7.2 Setting Schedule

You can configure record schedule, snapshot schedule and holiday schedule.



When holiday schedule setting is not the same as the general setting, holiday schedule setting is prior to the general setting. For example, with **Holiday Schedule** enabled, if the day is holiday, the system snapshots or records as holiday schedule setting; otherwise, the system snapshots or records as general setting

Set certain days as holiday, and when the **Record** or **Snapshot** is selected in the holiday schedule, the system takes snapshot or records video as holiday schedule defined.

Preparation

- Set the record mode to be **Auto** in **Record Control**. For details, see "5.1.1.2.1 Setting Record Plan."
- Configure holiday record and snapshot schedule. For details, see "5.1.1.2.1 Setting Record Plan" and "5.1.1.3.1 Setting Snapshot Plan."

Procedure

Step 1 Select **Setting > Storage > Schedule > Holiday Schedule**.

The **Holiday Schedule** interface is displayed. See Figure 4-83.

Figure 4-83 Holiday schedule

Step 2 Select **Record** or **Snapshot**.

Step 3 Select the days you need to set as holiday.

Those days with yellow color indicates that they were set as holidays.

Step 4 Click **Save**.

4.7.3 Setting Destination

This section introduces the configuration of the storage method for the recorded videos and snapshots.

4.7.3.1 Path

You can select different storage paths for the recorded videos and snapshots according to event type. You can select from SD card, FTP and NAS.



Local is displayed only on models that support SD card.

Step 1 Select **Setting > Storage > Destination > Path**.

The **Path** interface is displayed. See Figure 4-84.

Figure 4-84 Path

Step 2 Select the storage method that you need for the recorded videos and snapshots of different types.

Table 4-32 Description of path parameters

Parameter	Description
Event Type	Select from Scheduled , Motion Detection and Alarm .
Local	Save in the internal SD card.
FTP	Save in the FTP server.
NAS	Save in the NAS (network attached storage).

Step 3 Click **Save**.

Step 4 Configure other path parameters on **Destination**, **FTP** or **NAS** interface. For details, see "4.7.3 Setting Destination", "4.7.3.3 FTP" or "4.7.3.4 NAS."

4.7.3.2 Local

Display the information of the local SD card. You can set it as read only or read & write; you can also hot swap and format SD card, and reset password for it. When inserting smart card onto a device available for it, there are 3 modes according to the SD card status:

- Normal mode: The new SD cards and the cards whose password are cleared successfully show normal mode. The SD cards of this status do not support authorization operation.

- Unauthorized mode: The SD card authorized by other devices shows unauthorized mode. The SD cards of this status do not support operations of setting read only, read & write, formatting and encryption.
- Encrypted mode: The SD cards encrypted and authorized on this camera show encrypted mode. The camera can record max. 10 pieces of encrypted SD information. When the recorded videos exceed 10 pieces, the earliest ones will be overwritten.



- Functions might vary with different models, and the actual product shall prevail.
- If you enter the wrong password for five times when authorizing, modifying, and clearing password, the camera will be locked for five minutes.
- Make sure that the SD card has been authorized before recording and playback.
- The health status of SD card:
 - ◇ Green: The health status is excellent.
 - ◇ Blue: The health status is good.
 - ◇ Orange: The health status is moderate.
 - ◇ Red: The health status is poor, and you need to replace the SD card.

Select **Setting > Storage > Destination > Local**, and then the **Local** interface is displayed. See Figure 4-85.

- Click **Read Only**, and then the SD card is set to read only.
- Click **Read & Write**, and then the SD card is set to read & write.
- Click **Hot Swap**, and then you can pull out the SD card.
- Click **Refresh**, and then you can format the SD card.

Figure 4-85 Local

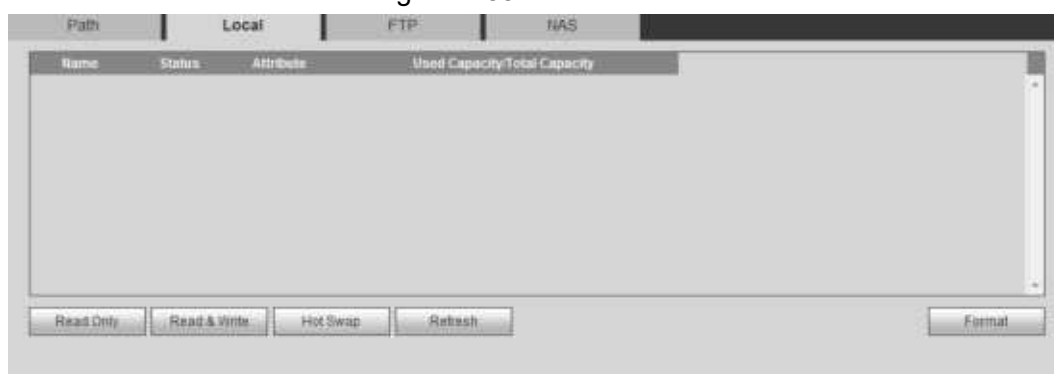

4.7.3.3 FTP

FTP function can be enabled only when it was selected as a destination path. When the network does not work, you can save all the files to the internal SD card for emergency.

Step 1 Select **Setting > Storage > Destination > FTP**.

The **FTP** interface is displayed. See Figure 4-86.

Figure 4-86 FTP

Step 2 Select the **Enable** check box to enable FTP function, and select the FTP type.



You select **FTP** or **SFTP** from the drop-down list. **SFTP** is recommended to enhance network security.

Step 3 Configure FTP parameters. For details, see Table 4-33.

Table 4-33 Description of FTP parameters

Parameter	Description
Server Address	The IP address of the FTP server.
Port	The port number of the FTP server.
Username	The user name to log in to the FTP server.
Password	The password to log in to the FTP server.
Remote Directory	The destination path in the FTP server.
Emergency (Local)	Select Emergency (Local) , and when the FTP server does not work, all the files are saved to the internal SD card.

Step 4 Click **Save**.

Step 5 Click **test** to test whether FTP function works normally.

4.7.3.4 NAS

This function can be enabled only when NAS was selected as a destination path. Enable this function, and you can save all the files in the NAS.

Step 1 Select **Setting > Storage > Destination > NAS**.

The **NAS** interface is displayed. See Figure 4-87.

Figure 4-87 NAS

Step 2 Select the **Enable** check box to enable NAS function, and select NAS protocol type.

- **NFS** (Network File System): A file system which enables computers in the same network share files through TCP/IP.
- **SMB** (Server Message Block): Provides shared access for clients and the server.

Step 3 Configure NAS parameters. For details, see Table 4-34.

Table 4-34 Description of NAS parameters

Parameter	Description
Server Address	The IP address of the NAS server.
Username	When selecting SMB protocol, you are required to enter user name and password. Enter them as needed.
Password	
Remote Directory	The destination path in the NAS server.

Step 4 Click **Save**.

4.8 System

This section introduces system configurations, including general, date & time, account, safety, PTZ settings, default, import/export, remote, auto maintain and upgrade.

4.8.1 General

You can configure device name, language and video standard.

Step 1 Select **Setting > System > General > General**.

The **General** interface is displayed. See Figure 4-88.

Figure 4-88 General

Step 2 Configure general parameters. For details, see Table 4-35.

Table 4-35 Description of general parameters

Parameter	Description
Name	<p>The name of the device.</p>  <p>Each device has its own name.</p>

Parameter	Description
Language	Select system language.
Video Standard	Select video standard from PAL and NTSC .
TVOut	<p>Select On or Off. This function is available on models with analog output.</p>  <ul style="list-style-type: none"> If the TV out is On, smart plans will be disabled; if the smart plans are enabled, the TV out will be set as Off. SDI and HDCVI are available on select models.

Step 3 Click **Save**.

4.8.2 Date & Time

You can configure date and time format, time zone, current time, DST (Daylight Saving Time) or NTP server.

Step 1 Select **Setting > System > General > Date & Time**.

The **Date & Time** interface is displayed. See Figure 4-89.

Figure 4-89 Date and time



Step 2 Configure date and time parameters. For details, see Table 4-36.

Table 4-36 Description of date and time parameters

Parameter	Description
Date Format	Configure the date format.
Time Format	Configure the time format. You can select from 12-Hour or 24-Hour .
Time Zone	Configure the time zone that the camera is at.
Current Time	Configure system time. Click Sync PC , and the system time changes to the PC time.
DST	Enable DST as needed. Select the check box, and configure start time and end time of DST with Date or Week .
NTP	Select the check box, and then NTP (network time protocol) is enabled,

Parameter	Description
NTP Server.	the system then syncs time with the internet server in real time. You can also enter the IP address, time zone, port, and interval of a PC which installed NTP server to use NTP.
Time Zone	
Port	
Interval	

Step 3 Click **Save**.

4.8.3 Splicing

When the panorama contains multiple images of various lens, enable this function. Before splicing, make sure that the surveillance scene is large and there is no shield on the image, and do not move the camera; otherwise, the splicing might fail.

Step 1 Select **Setting > System > General > Splicing**

The **Splicing** interface is displayed. See Figure 4-90 and Figure 4-91.

Figure 4-90 Splicing (1)

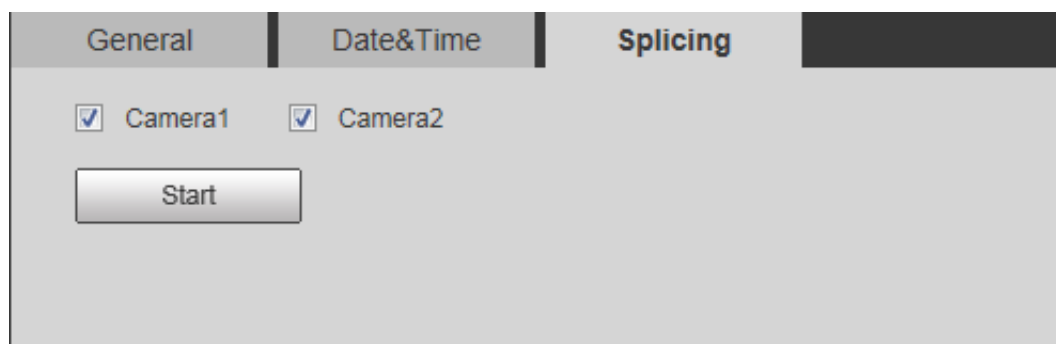
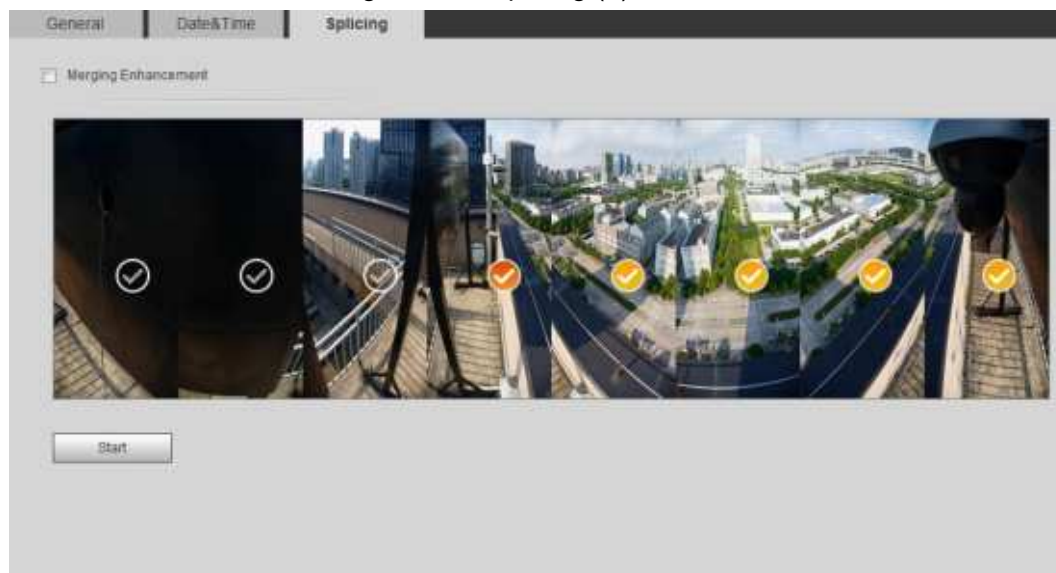



Figure 4-91 Splicing (2)



Step 2 Select the camera which needs to be spliced.

When splicing the image through selecting lenses, you need to select the continuous splicing screens. The screen with the icon  (deeper color) means the first screen of the splicing. You can select any screen as the first one, and select the following screens continuously. The system supports the splicing of 4, 5, 6, 7 and 8 sensors.



This function is available on some select models. And it is all sensors splicing by default.

Step 3 Click **Start**.

The system begins to splice image.

- Some camera restarts automatically after splicing is completed, and you can view the splicing effect on the **Live** interface.
- Some camera displays splicing live view interface after splicing is completed. Click **OK**, and then the system prompts default box. And then click **OK**. The splicing takes effect.

4.8.4 Account

Manage all the users. You can add, delete, or modify users. Users include admin, added users and ONVIF users.

Managing users and groups are only available for administrator users.

- The max length of the user or group name is 31 characters which consisted of number, letters, underline, dash, dot and @.
- The password must consist of 8 to 32 non-blank characters and contain at least two types of characters among upper case, lower case, number, and special character (excluding ' " ; : &).
- You can have 18 users and 8 groups at most.
- You can manage users through single user or group, and duplicate user names or group names are not allowed. A user can be in only one group at a time, and the group users can own authorities within group authority range.
- Online users cannot modify their own authority.
- There is one admin by default which has highest authority.
- Select **Anonymous Login**, and then log in with only IP address instead of user name and password. Anonymous users only have preview authorities. During anonymous login, click **Logout**, and then you can log in with other username.

4.8.4.1 Adding a User

You are admin user by default. You can add users, and configure different authorities.

Step 1 Select **Setting > System > Account > Account > Username**.

The **Username** interface is displayed. See Figure 4-92.

Figure 4-92 Username

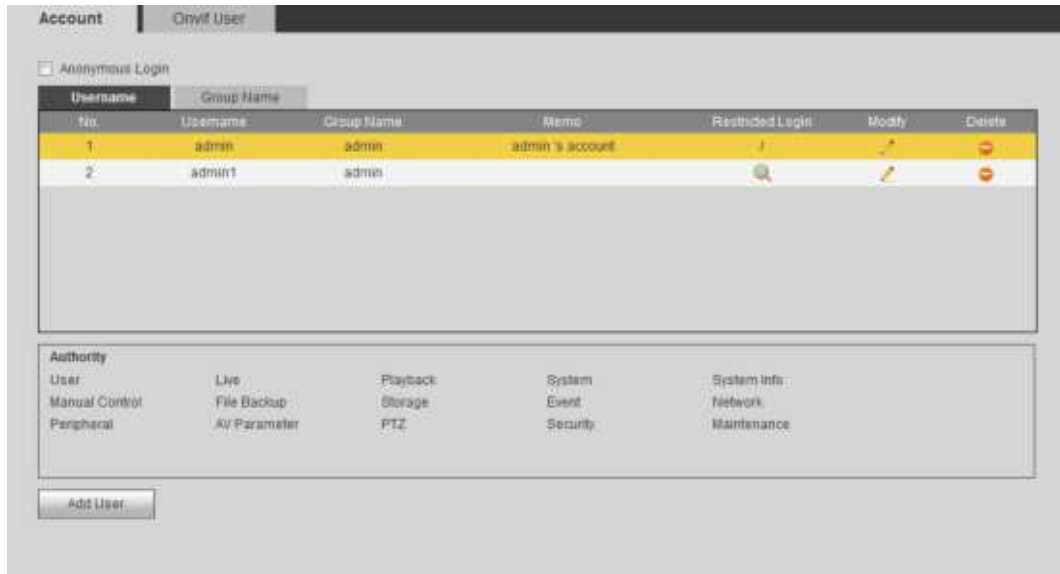

Step 2 Click **Add User**.

The **Add User** interface is displayed. See Figure 4-93 and Figure 4-94.

Figure 4-93 Add user (operation permission)

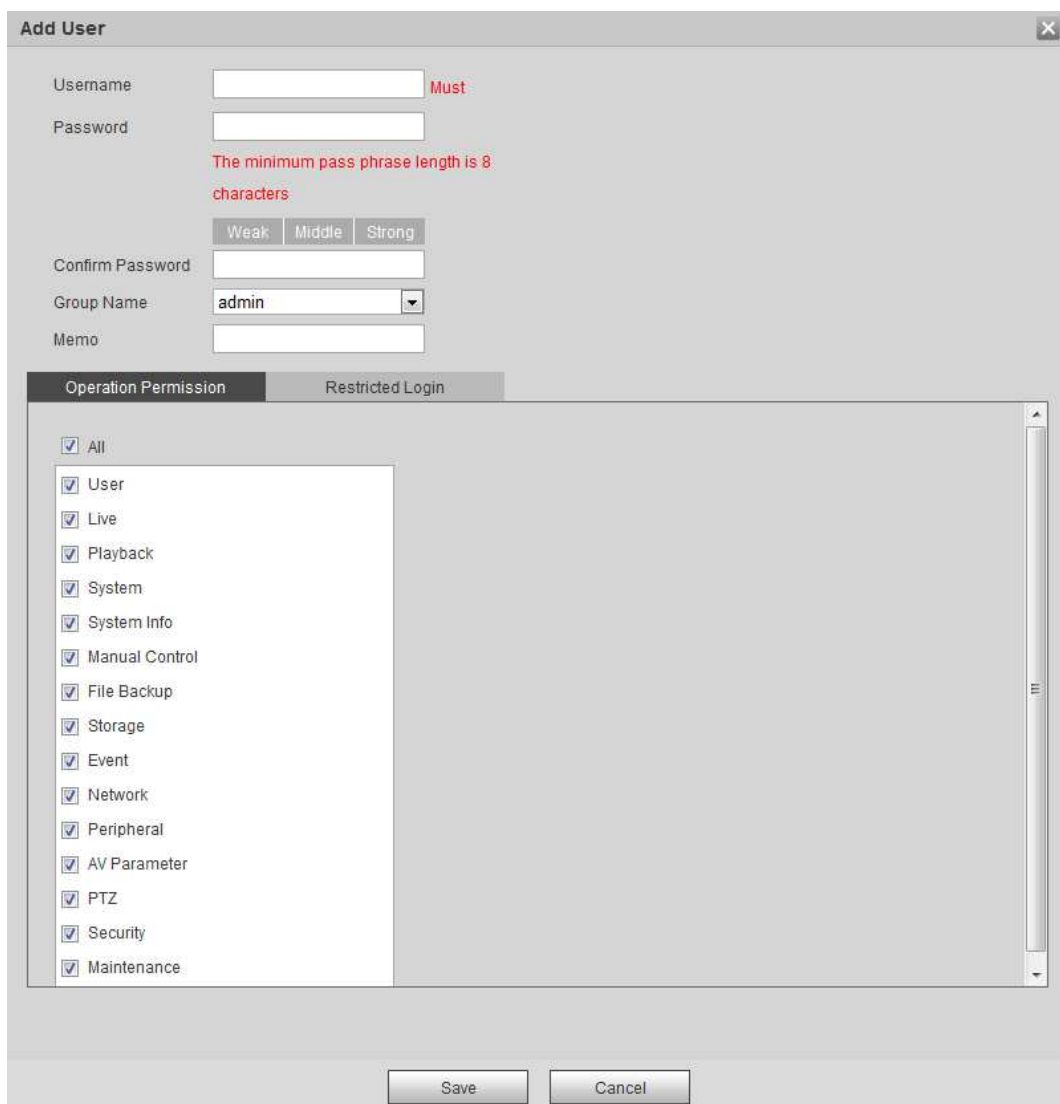



Figure 4-94 Add user (restricted login)

The screenshot shows the 'Add User' dialog box with the following fields and options:

- Username:** A text input field with a red asterisk and the word 'Must' next to it.
- Password:** A text input field.
- Confirm Password:** A text input field.
- Group Name:** A dropdown menu currently set to 'admin'.
- Memo:** A text input field.
- Operation Permission:** A tabbed interface with 'Restricted Login' selected.
- Restricted Login Section:**
 - IP Address: Includes a dropdown for 'IPv4', another dropdown for 'IP Address', and a field containing '1 . 0 . 0 . 1'.
 - Validity Period: Includes 'Begin Time' (2019-07-18, 08:00:00) and 'End Time' (2019-07-19, 08:00:00).
 - Time Range: A grid showing days of the week (Sun-Sat) and hours (0-24). All cells in the grid are highlighted in green. To the right of the grid are 'Setting' buttons for each day.
- Buttons:** 'Save' and 'Cancel' buttons at the bottom.

Step 3 Configure user parameters. For details, see Table 4-37.

Table 4-37 Description of user parameters (1)



Parameter	Description
Username	User's unique identification. You cannot use existed user name.
Password	Enter password and confirm it again. The password must consist of 8 to 32 non-blank characters and contain at least two types of characters among upper case, lower case, number, and special character (excluding ' " ; &).
Confirm Password	
Group Name	The group that users belong to. Each group has different authorities.
Memo	Describe the user.
Operation Permission	Select authorities as needed.  It is recommended to give fewer authorities to normal users than premium users.

Parameter	Description
Restricted Login	<p>Set the PC address that allows the defined user to log in to the camera and the validity period and time range. You can log in to web with the defined IP in the defined time range of validity period.</p> <ul style="list-style-type: none"> ● IP address: You can log in to web through the PC with the set IP. ● Validity period: You can log in to web in the set validity period. ● Time Range: You can log in to web in the set time range. <p>Set as following:</p> <ol style="list-style-type: none"> 1. Select IP Address: Select IP type and set IP address. <ul style="list-style-type: none"> ◇ IP Address: Enter the IP address of the host to be added. ◇ IP segment: Enter the start address and end address of the host to be added. 2. Select Validity Period: Set the begin time and end time. 3. Select Time Range: Set the time range that allow user to log in. For details, see "5.1.1.1 Setting Period."

Step 4 Click **Save**.

The newly added user is displayed in the user name list.



- After adding user, click  to modify password, group, memo or authorities; click  to delete the added users. Admin user cannot be deleted.
- Click  in the **admin** row to modify its username and email address.

4.8.4.2 Adding User Group

You have two groups named admin and user by default, and you can add new group, delete added group or modify group authority and memo.

Step 1 Select **Setting > System > Account > Account > Group Name**.

The **Group Name** interface is displayed. See Figure 4-95.

Figure 4-95 Group name

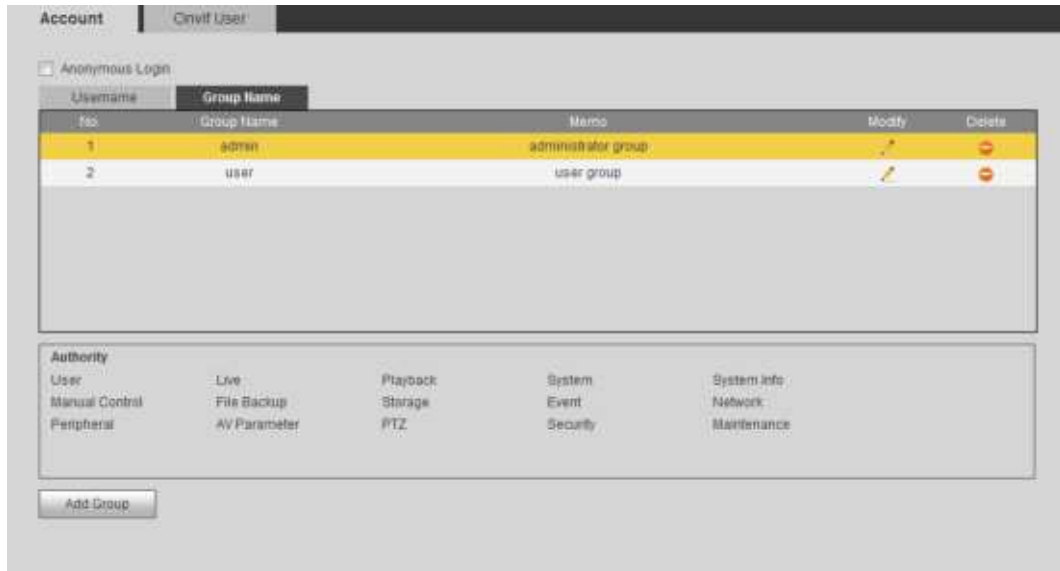

Step 2 Click **Add Group**.

The **Add Group** interface is displayed. See Figure 4-96.

Figure 4-96 Add group

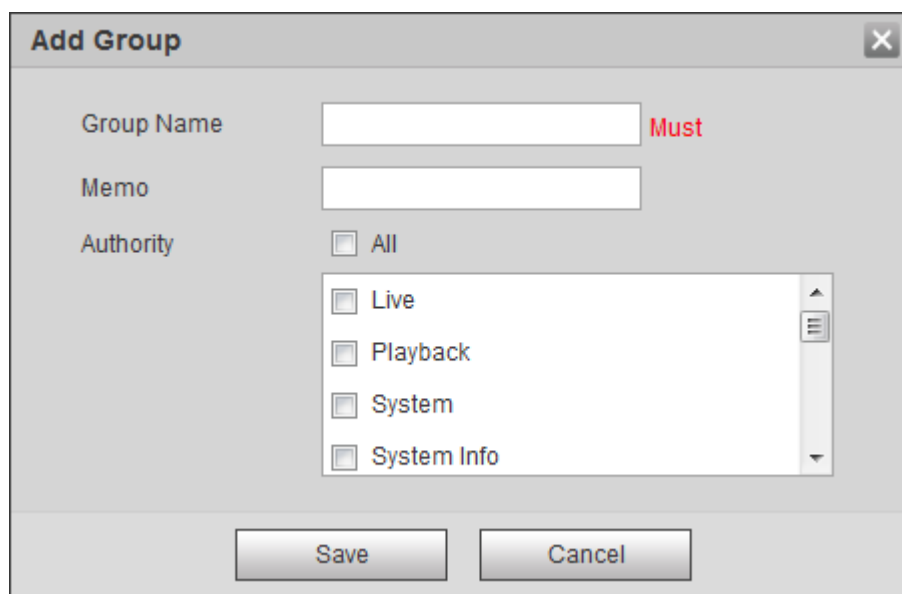



Step 3 Enter the group name and memo, and then select group authorities.

Step 4 Click **Save** to finish configuration.

The newly added group displays in the group name list.



- After adding group, click  to modify group memo or authorities; click  to delete the added group, admin group and user group cannot be deleted.
- Click  in the row of admin group or user group to modify group memo.

4.8.4.3 ONVIF User

You can add, delete ONVIF user, and modify their passwords.

Step 1 Select **Setting > System > Account > ONVIF User**.

The **ONVIF User** interface is displayed. See Figure 4-97.

Figure 4-97 ONVIF user

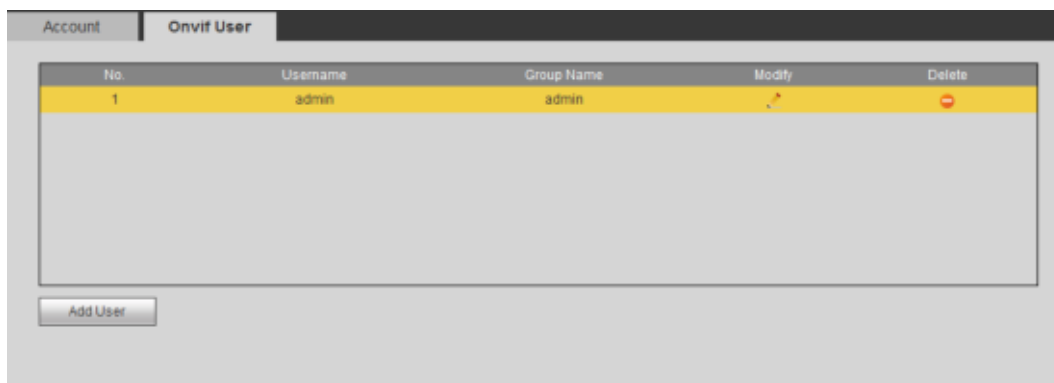

Step 2 Click **Add User**.

The **Add User** interface is displayed. See Figure 4-98.

Figure 4-98 Add user

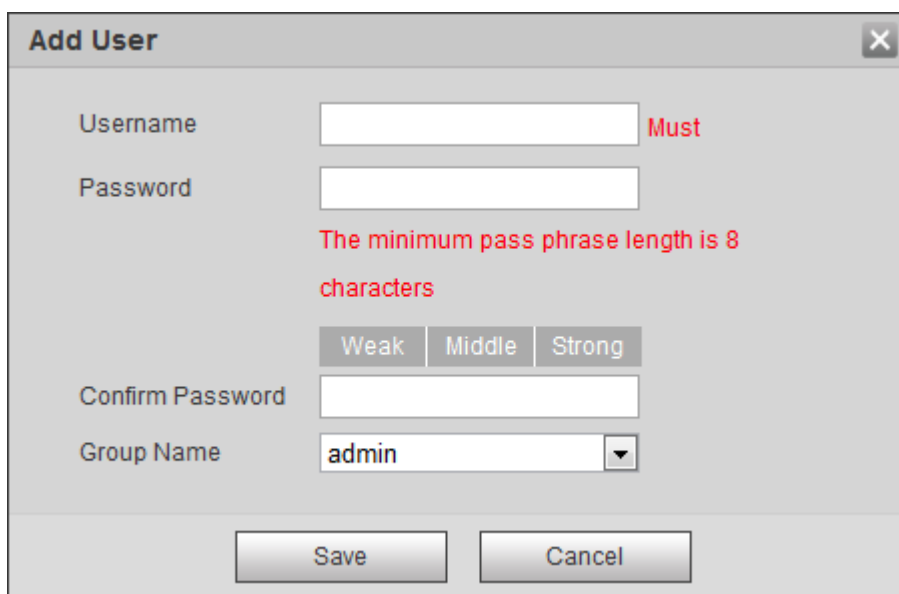

Step 3 Configure user parameters. For details, see Table 4-38.



Table 4-38 Description of user parameters (2)

Parameter	Description
Username	User's unique identification. You cannot use existed user name.
Password	Enter password and confirm it again.
Confirm Password	The password must consist of 8 to 32 non-blank characters and contain at least two types of characters among upper case, lower case, number, and special character (excluding ' " ; : &).
Group Name	The group that users belong to. Each group has different authorities.

Step 4 Click **Save**.

The newly added user displays in the user name list.



- After adding user, click  to modify password, group, memo or authorities; click  to delete the added user. Admin user cannot be deleted.
- Click  in the **admin** row to modify its username and email address.

4.8.5 Safety

You can configure system service, HTTPS, and Firewall.

4.8.5.1 System Service

Configure the IP hosts (devices with IP address) that are allowed to visit the device. Only the hosts in the trusted sites list can log in to the web interface. This is to enhance network and data security.

Step 1 Select **Setting > System > Safety > System Service**.

The **System Service** interface is displayed. See Figure 4-99.

Figure 4-99 System service

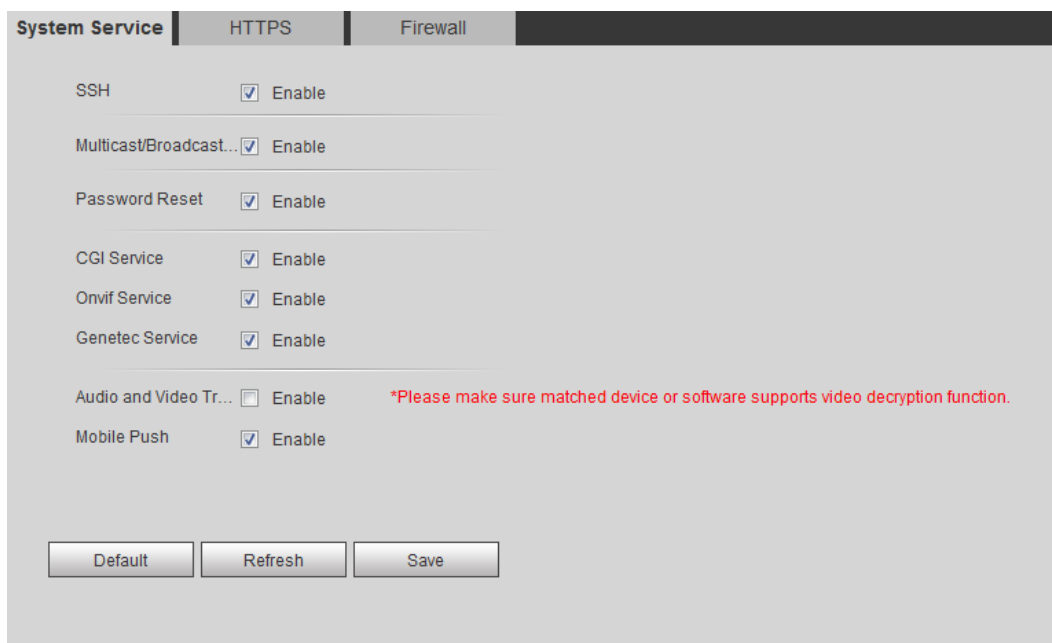

Step 2 Enable the system service according to the actual needs. For details, see Table 4-39.

Table 4-39 Description of system service parameters

Function	Description
SSH	You can enable SSH authentication to perform safety management.
Multicast/Broadcast Search	Enable this function, and then when multiple users are previewing the device video image simultaneously through network, they can find

Function	Description
	your device with multicast/broadcast protocol.
Password Reset	Manage system security with this function.
CGI Service	Enable this function, and then other devices can access through this service.
Onvif Service	Enable this function, and then other devices can access through this service.
Genetec Service	Enable this function, and then other devices can access through this service.
Audio and Video Transmission Encryption	<p>Enable to encrypt audio/video transmission.</p>  <p>Make sure that the other devices and software that working together with the camera support video decryption.</p>
Mobile Push	Enable this function, and then the system would send the snapshot that was taken when alarm is triggered to your phone, this is enabled by default.

Step 3 Click **Save**.

4.8.5.2 HTTPS

Create certificate or upload the authenticated certificate, and then you can log in through HTTPS with your PC. The HTTPS can protect page authenticity on all types of websites, secure accounts, and keep user communications, identity, and web browsing private.

Step 1 Create certificate or upload the authenticated certificate.

- If you select **Create Certificate**, follow the steps below.
 - 1) Select Setting > Network > HTTPS.

The **HTTPS** interface is displayed. See Figure 4-100.

Figure 4-100 HTTPS (1)

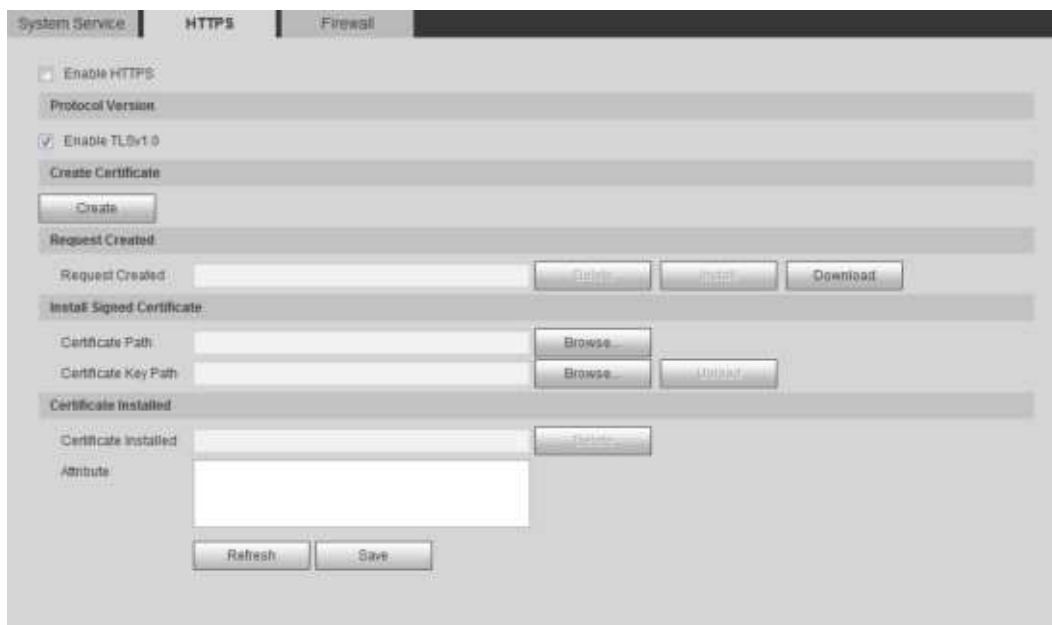

The screenshot displays the HTTPS configuration page. At the top, there are three tabs: "System Service", "HTTPS", and "Firewall". The "HTTPS" tab is active. Below the tabs, there are several sections:

- Enable HTTPS:** A checkbox labeled "Enable HTTPS" is currently unchecked.
- Protocol Version:** A text input field.
- Enable TLSv1.0:** A checkbox labeled "Enable TLSv1.0" is checked.
- Create Certificate:** A section with a "Create" button.
- Request Created:** A section with a "Request Created" label, an input field, and three buttons: "Delete", "Install", and "Download".
- Install Signed Certificate:** A section with "Certificate Path" and "Certificate Key Path" labels, each followed by a "Browse" button, and a "Upload" button.
- Certificate Installed:** A section with a "Certificate Installed" label, an input field, and a "Refresh" button.
- Attributes:** A section with an empty input field.

At the bottom of the page, there are two buttons: "Refresh" and "Save".

- 2) Click **Create**.
The **HTTPS** dialog box is displayed. See Figure 4-101.

Figure 4-101 **HTTPS** dialog box

- 3) Enter the required information and then click **Create**.



The entered **IP or Domain name** must be the same as the IP or domain name of the device.

- 4) Click **Install**. See Figure 4-102.

Figure 4-102 Certificate installation

- 5) Click **Download** to download root certificate.
- 6) Click **Download Root Certificate**.

The **File Download-Security Warning** dialogue box is displayed. See Figure 4-103.

Figure 4-103 File download



- 7) Click **Open**. The **Certificate Information** interface is displayed. See Figure 4-104.

Figure 4-104 Certificate information

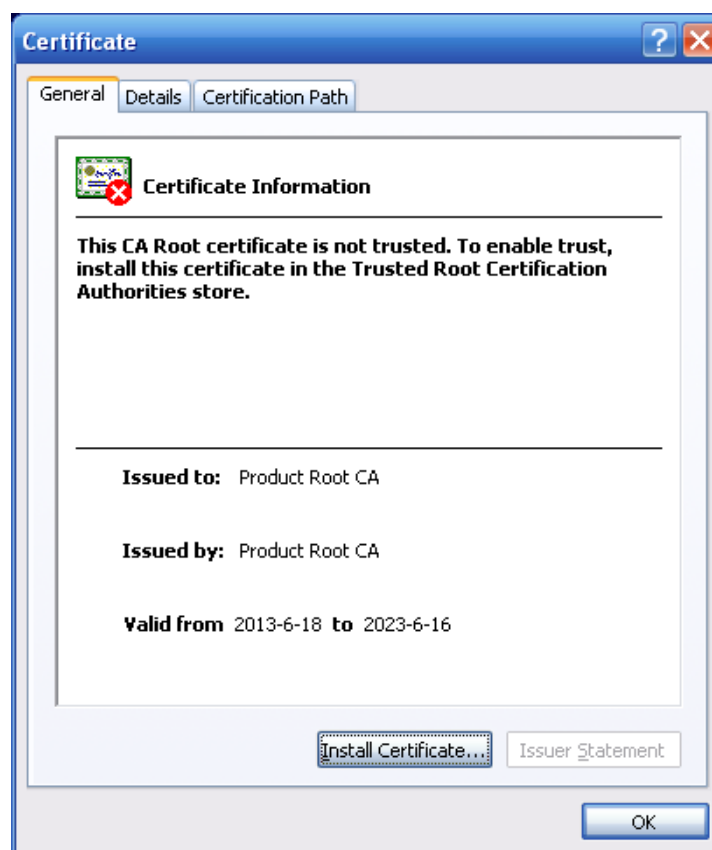

- 8) Click Install Certificate.
9) The **Certificate Import Wizard** interface is displayed. See Figure 4-105.

Figure 4-105 Certificate import wizard



10) Click **Next**.

The **Certificate Store** interface is displayed. See Figure 4-106.

Figure 4-106 Certificate import wizard

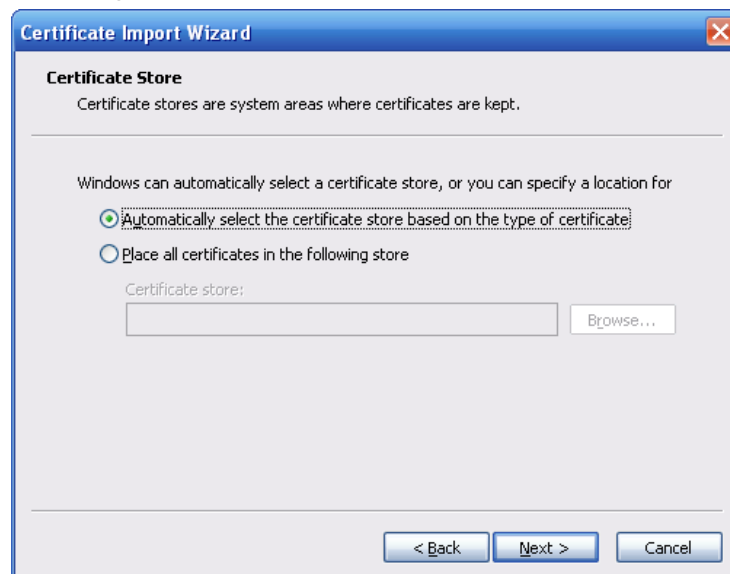

11) Select the storage location and click **Next**.

The **Certificate Import Wizard** interface is displayed. See Figure 4-107.

Figure 4-107 Certificate import wizard



- 12) Click **Finish** and a dialog box showing **The import was successful** pops up. See Figure 4-108.

Figure 4-108 Import succeeds



4.8.5.3 Firewall

Configure **Network Access**, **PING prohibited** and **Prevent Semijoin** to enhance network and data security.

- **Network Access:** Set trusted list and restricted list to limit access.
 - ◇ **Trust list:** Only when the IP/MAC of your PC in the trusted list, can you access the camera. Ports are the same.
 - ◇ **Banned list:** When the IP/MAC of your PC is in the banned list, you cannot access the camera. Ports are the same.
- **PING prohibited:** Enable **PING prohibited** function, and the camera will not respond to the ping request.
- **Prevent Semijoin:** Enable **Prevent Semijoin** function, and the camera can provide service normally under Semijoin attack.



- You cannot set trust or banned list for camera IP or MAC addresses.
- You cannot set trust or banned list for port MAC addresses.

- When the IP addresses of the camera and your PC are in the same LAN, MAC verification takes effect.
- When you access the camera through internet, the camera verifies the MAC address according to the router MAC.

This section takes **Network Access** as an example.

Step 1 Select **Setting > System > Safety > Firewall**.

The **Firewall** interface is displayed. See Figure 4-109.

Figure 4-109 Firewall

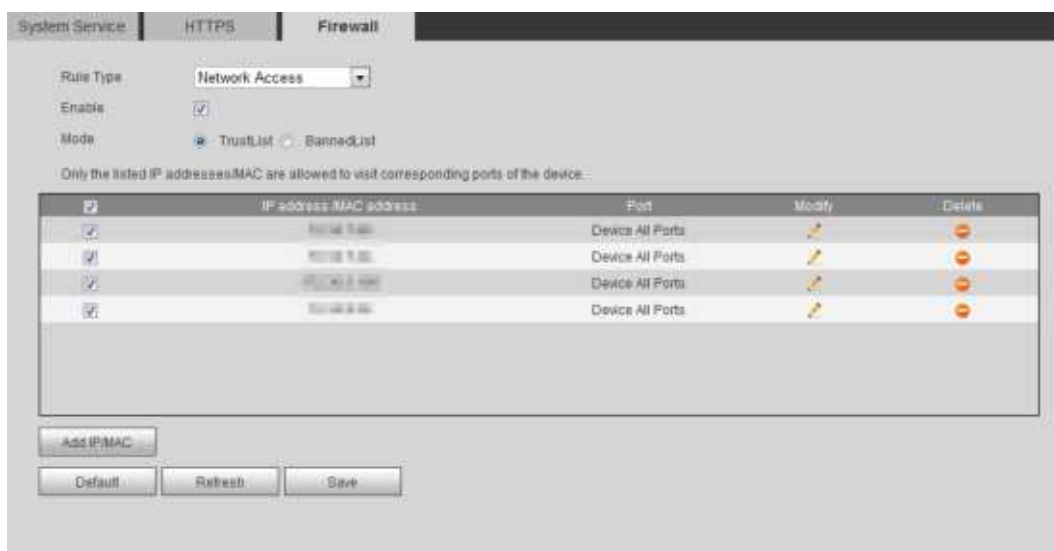

Step 2 Select **Network Access** from **Rule Type** list, and then select the **Enable** check box.

- Enable **PING prohibited** and **Prevent Semijoin**, and click **Save**. You do not need to configure parameters.
- Enable **Network Access**, and configure trust list and banned list.
 - 1) Select the mode: **TrustList** and **BannedList**.
 - 2) Click **Add IP/MAC**.

The **Add IP/MAC** interface is displayed. See Figure 4-110.

Figure 4-110 Add IP/MAC

Add IP/MAC

Rule Type: IP Address

IP Version: IPv4

IP Address: 1

Device All Ports:

Device Start Server...: 1

Device End Server...: 1

OK Cancel

Step 3 Configure parameters. For details, see Table 4-40.

Table 4-40 Description of adding IP/MAC parameters

Parameter	Description
Rule Type	Select IP address, IP segment, MAC address or all IP addresses. <ul style="list-style-type: none"> • IP address: Select IP version and enter the IP address of the host to be added. • IP segment: Select IP version and enter the start address and end address of the segment to be added. • MAC address: Enter MAC address of the host to be added. • All IP addresses: Set all IP addresses in trusted list or restricted list.
Device All Ports	Set access ports. You can select all ports or the ports in defined areas. <ul style="list-style-type: none"> • Device all ports: Set all IP port in trust list or Banned list. When selecting BannedList in Mode, and All IP Address in Rule Type, you cannot select the Device All Ports check box. • Device start server port and Device end server port: Set Device start server port and device end server port, and the range is 1–65535.
Device Start Server Port	
Device End Server Port	

Step 4 Click **OK**, and the **Firewall** interface is displayed.

Step 5 Click **Save**.

4.8.6 Peripheral

4.8.6.1 Serial Port Settings

Set the serial port of the external device.

Step 1 Select **Setting > System > Peripheral > Serial Port Settings**.

The **Serial Port Settings** interface is displayed. See Figure 4-111.

Figure 4-111 Serial port settings

Step 2 Configure serial port settings parameters. For details, see Table 4-41.

Table 4-41 Description of serial port settings parameters

Parameter	Description
Address	<p>The corresponding device address. It is 1 by default.</p>  <p>Make sure that the address is the device address; otherwise you cannot control the device.</p>
Baud Rate	Select the boud rate for the camera. It is 9600 by default.
Date Bit	It is 8 by default.
Stop Blt	It is 1 by default.
Parity	It is None by default.

Step 3 Click **Save**.

4.8.6.2 External Light

You need to configure external light mode when the external light is used.

Preparation

- Connect external light with RS-485 port.
- You have configured serial port parameters. For details, see "4.8.6.1 Serial Port Settings."

Procedure

Step 1 Select **Setting > System > Peripheral > External Light**.

The **External Light** interface is displayed. See Figure 4-112.

Figure 4-112 External light

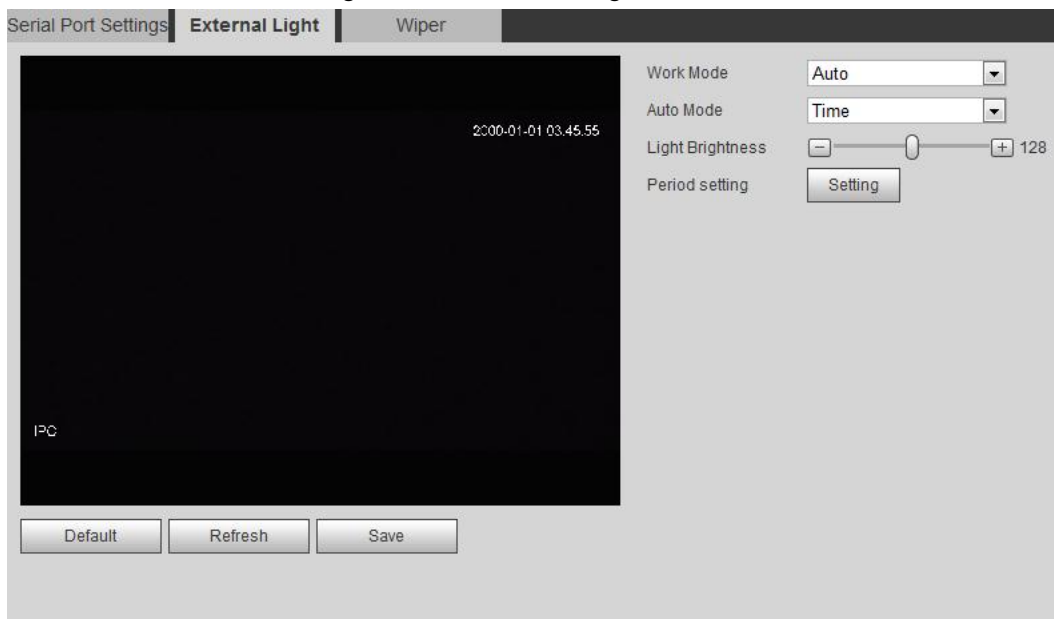

Step 2 Configure external light work mode. For details, see Table 4-42.

Table 4-42 Description of external light parameters

Parameter	Description
Work Mode	<ul style="list-style-type: none"> Off: Turn off the external light. Manual: Set the light brightness manually. Auto: The camera turns on or turns off the light according to the light time and photoresister automatically.
Auto Mode	<p>Time: When selecting Time in Auto Mode, click Setting to set the arming period. During the arming period, the external light is on. For details of arming period setting, see "5.1.1.1 Setting Period."</p> <p>Photoresister: When you select Photoresister in Auto Mode, the system turns on the external light according to the brightness automatically.</p>
Light Brightness	Set the brightness of the external light.

Step 3 Click **Save**.

4.8.6.3 Wiper

Step 1 Select **Setting > System > Peripheral > Wiper**.

The **Wiper** interface is displayed. See Figure 4-113.

Figure 4-113 Wiper

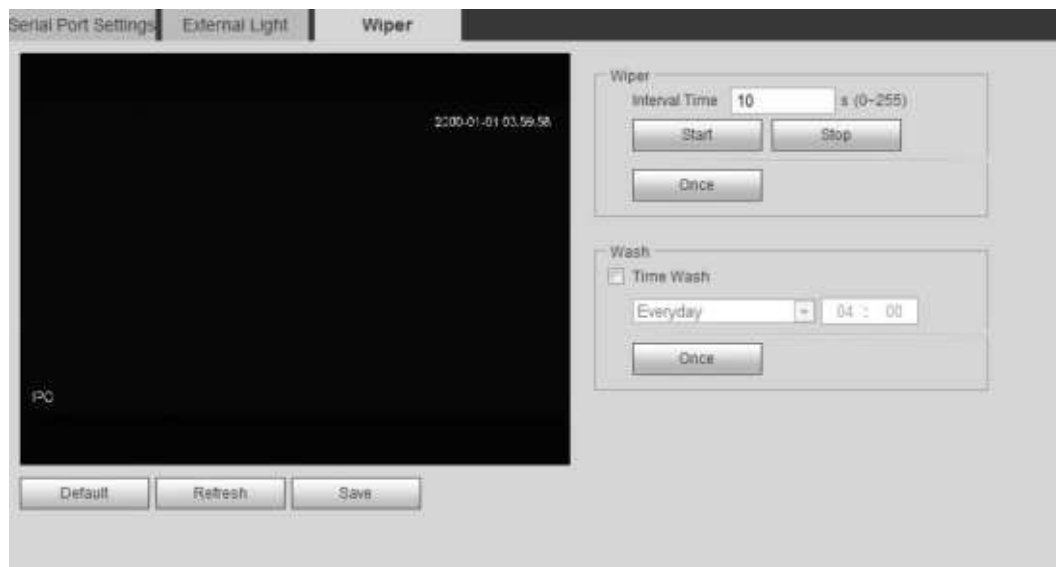

Step 2 Configure wiper work mode. For details, see Table 4-43.

Table 4-43 Description of wiper parameters

Parameter	Description
Interval Time	The interval time between stop mode and start mode. For example, set the time to 10 s, and the wiper will work every 10 s.
Start	Set the work status of the wiper. <ul style="list-style-type: none"> Start: Click Start, and the wiper works as the set interval time. Stop: Click Stop, and the wiper stops working. Once: Click Once, and the wiper works once.
Stop	
Once	
Time Wash	Select the Time Wash check box and set the time, and then the wiper will work as the set time. Click Once , and the wiper works once. It can be used to check whether the wiper can work normally.

Step 3 Click **Save**.

5 Event

This chapter introduces intelligent event settings, including smart track, panoramic calibration, video detection, audio detection, smart plan, IVS, face detection, face recognition, people counting, heat map, video structuralization, alarm, and abnormality.

5.1 Setting Alarm Linkage

5.1.1 Alarm Linkage

When configuring alarm events, select alarm linkages (such as record, snapshot). See Figure 5-1. When the corresponding alarm is triggered in the configured arming period, the system will alarm.

Figure 5-1 Alarm linkage

Period

Anti-Dither s (0~100) Sensor Type

Record

Record Delay s (10~300)

Relay-out

Alarm Delay s (10~300)

Send Email

PTZ

Snapshot

5.1.1.1 Setting Period

Set arming periods. The system only performs corresponding linkage action in the configured period.

Step 1 Click **Setting** next to **Period**.

The **Period** interface is displayed. See Figure 5-2.

Figure 5-2 Period

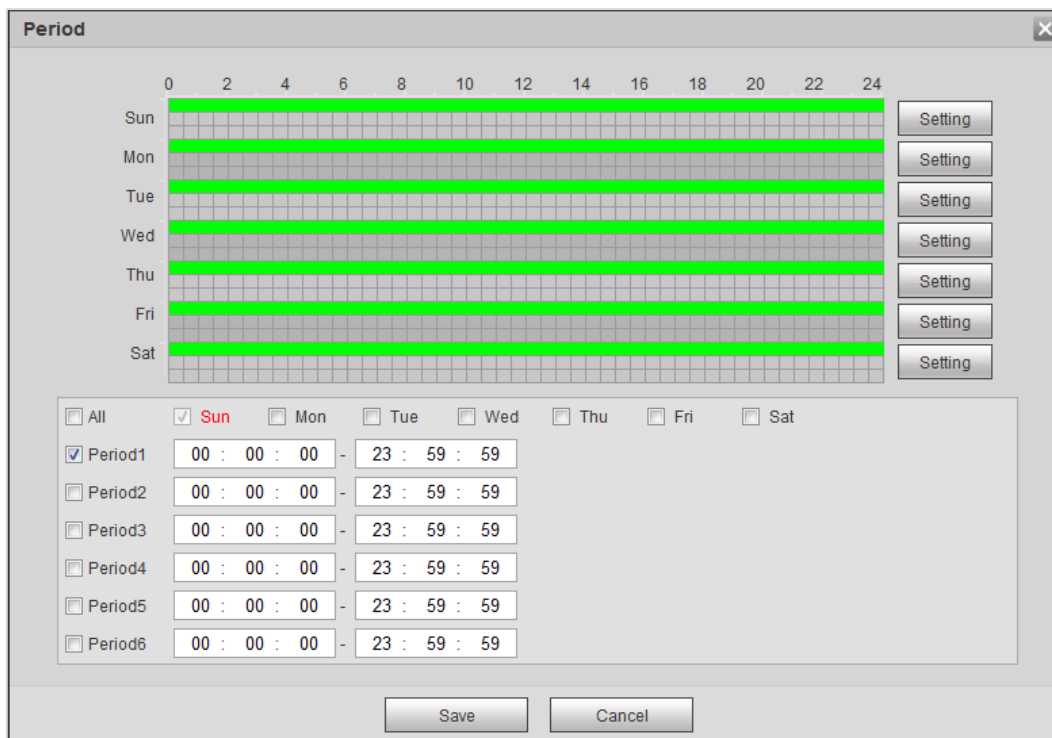

Step 2 Set arming periods. Alarms will be triggered in the time period in green on the timeline.

- Method one: Directly press and drag the left mouse button on the timeline.
- Method two: Enter an actual time period.
 - 1) Click **Setting** next to a day.
 - 2) Select a time period to be enabled.
 - 3) Enter start time and end time of a time period.



- ◇ Select **All** or check boxes of some days to set the time period of multiple days at one time.
- ◇ You can set 6 time periods per day.

Step 3 Click **Save**.

5.1.1.2 Record Linkage

The system can link record channel when an alarm event occurs. After alarm, the system stops recording after an extended time period according to the **Record Delay** setting.

To use the record linkage function, set record plan for motion detection alarm and enable auto recording in record control.

5.1.1.2.1 Setting Record Plan

After the corresponding alarm type (**Normal**, **Motion**, **Alarm**) is enabled, the record channel links recording.

Step 1 Select **Setting > Storage > Schedule > Record**.

The **Record** interface is displayed. See Figure 5-3.

Figure 5-3 Record

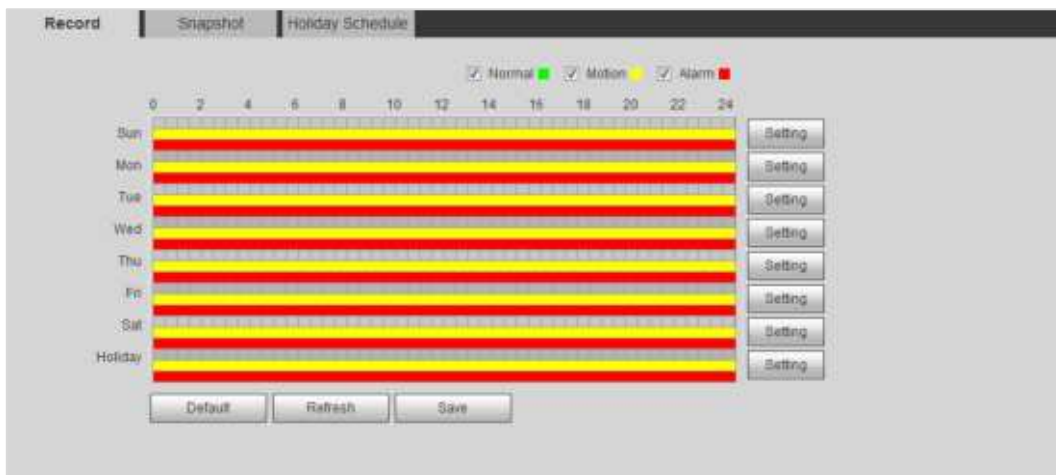

Step 2 Set record plan.

Green represents normal record plan (such as timing recording); yellow represents motion record plan (such as recording triggered by intelligent events); red represents alarm record plan (such as recording triggered by alarm-in).

- Method one: Select a record type, such as **Normal**, and directly press and drag the left mouse button to set the time period for normal record on the timeline.
- Method two: Enter an actual time period.
 - 1) Click **Setting** next to a day.

The **Setting** interface is displayed. See Figure 5-4.

Figure 5-4 Setting (record time period)

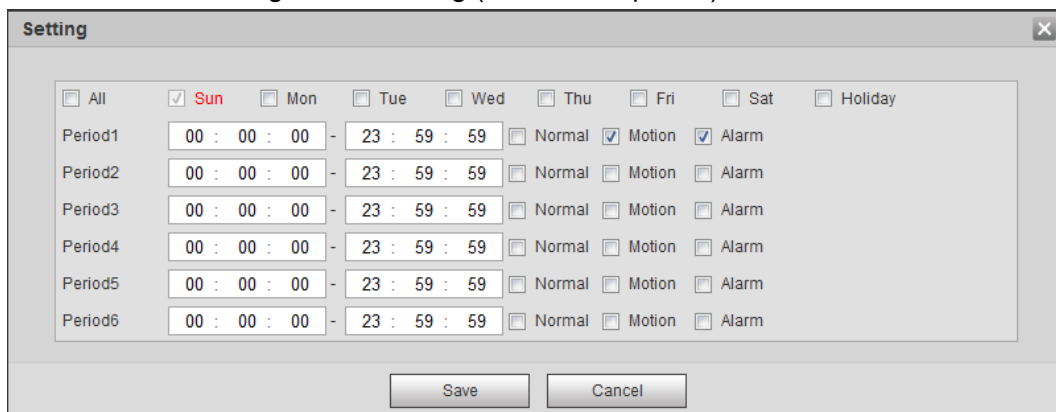

- 2) Select a day, and the alarm type next to a period, and then set the period.



- ◇ Select **All** or check boxes of some days to set the time period of multiple days at one time.
- ◇ You can set 6 time periods per day.

- 3) Click **Save**.

The **Record** interface is displayed.

Step 3 Click **Save**.

5.1.1.2.2 Setting Record Control

Set parameters such as pack duration, pre-event record, disk full, record mode, and record stream.



Make sure that the SD card is authenticated before recording if you use smart card. For details, see "4.5.2.5 Path."

Step 1 Select **Setting > Storage > Record Control**.

The **Record Control** interface is displayed. See Figure 5-5.

Figure 5-5 Record control

Step 2 Set parameters. See Table 5-1.

Table 5-1 Description of record control parameters

Parameter	Description
Pack Duration	The time for packing each video file.
Pre-event Record	<p>The time to record the video in advance of a triggered alarm event. For example, if the pre-event record is set to be 5 s, the system saves the recorded video of 5 s before the alarm is triggered.</p>  <p>When an alarm or motion detection links recording, and the recording is not enabled, the system saves the video data within the pre-event record time to the video file.</p>
Disk Full	<p>Recording strategy when the disk is full.</p> <ul style="list-style-type: none"> ● Stop: Stop recording when the disk is full. ● Overwrite: Cyclically overwrite the earliest video when the disk is full.
Record Mode	When you select Manual , the system starts recording; when you select Auto , the system starts recording in the configured time period of record plan.
Record Stream	Select record stream, including Main Stream and Sub Stream .

Step 3 Click **Save**.

5.1.1.2.3 Setting Record Linkage

On the alarm event setting interface (such as the motion detection interface), select **Record** and set **Record Delay** to set alarm linkage and record delay.

After **Record Delay** is configured, alarm recording continues for an extended period after the alarm ends.

Figure 5-6 Record linkage



5.1.1.3 Snapshot Linkage

After snapshot linkage is configured, the system can automatically alarm and take snapshots when an alarm is triggered.

After **Motion** is enabled in **Snapshot**, the system takes snapshots when an alarm is triggered. For querying and setting snapshot storage location, see "4.5.2.5 Path."

5.1.1.3.1 Setting Snapshot Plan

According to the configured snapshot plan, the system enables or disables snapshot at corresponding time.

Step 1 Select **Setting > Storage > Schedule > Snapshot**.

The **Snapshot** interface is displayed. See Figure 5-1.

Figure 5-1 Snapshot



Step 2 Select snapshot type and set time period.

Green represents normal snapshot plan (such as timing snapshot); yellow represents motion snapshot plan (such as snapshot triggered by intelligent events); red represents alarm snapshot plan (such as snapshot triggered by alarm-in).

- Method one: Select snapshot type, such as **Normal**, and directly press and drag the left mouse button to set time period for normal snapshot on the timeline.
- Method two: Enter an actual time period.
 - 1) Click **Setting** next to a day.

The **Setting** interface is displayed. See Figure 5-2.

Figure 5-2 Setting (snapshot time period)

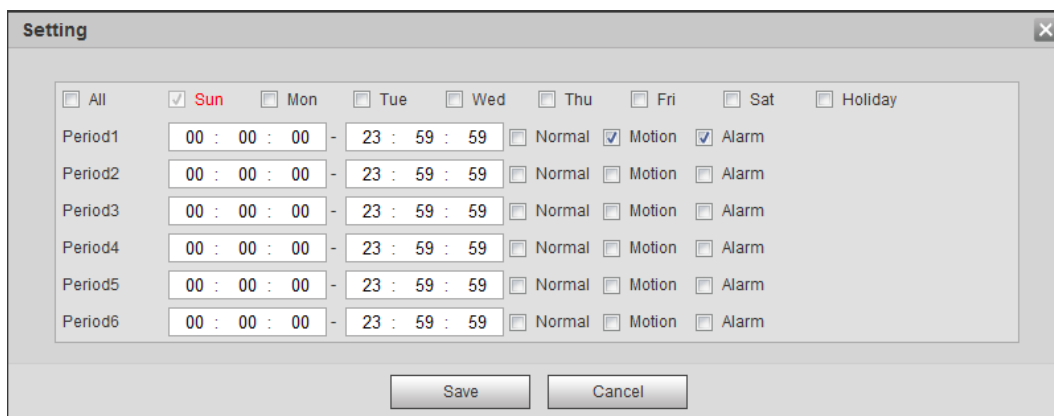

2) Select a day, and the alarm type next to a period. Then set the period.



- ◇ Select **All** or check boxes of some days to set the time period of multiple days at one time.
- ◇ You can set 6 time periods per day.

3) Click **Save**.

The **Snapshot** interface is displayed.

Step 3 Click **Save**.

5.1.1.3.2 Setting Snapshot Linkage

On the alarm event setting interface (such as the motion detection interface), select **Snapshot** and set alarm linkage snapshot.

Figure 5-3 Snapshot linkage



5.1.1.4 Relay-out Linkage

When an alarm is triggered, the system can automatically link with relay-out device.

On the alarm event setting interface (such as the motion detection interface), select **Alarm** and set **Alarm Delay**.

When alarm delay is configured, alarm continues for an extended period after the alarm ends.

Figure 5-4 Relay-out linkage



5.1.1.5 Email Linkage

When an alarm is triggered, the system will automatically send an email to users.

Email linkage takes effect only when SMTP is configured. For details, see "4.6.5 SMTP (Email)."

Figure 5-5 Email linkage



A screenshot of a user interface element showing a single checkbox labeled "Send Email". The checkbox is currently unchecked.

5.1.1.6 PTZ Linkage

When an alarm is triggered, the system links PTZ to do some operations. For example, the system links PTZ to rotate to the preset X.

Figure 5-6 PTZ linkage

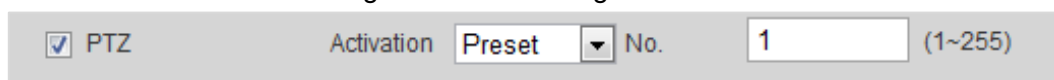

A screenshot of a user interface element for PTZ linkage. It features a checked checkbox labeled "PTZ". To its right, the word "Activation" is followed by a dropdown menu currently set to "Preset". Further right is the label "No." followed by a text input field containing the number "1" and a range indicator "(1~255)".

5.1.1.7 White Light Linkage

When an alarm is triggered, the system can automatically enable the white light.

Set **Mode**, **Duration**, **Flicker Frequency**, **Duration**, and **Period**.

- **Mode:** The display mode of the white light when an alarm is triggered. It includes **Normally on** and **Flicker**. When set flicker as the mode, you need to set the flicker frequency.
- **Duration:** After setting white light duration, the white light is turned off after an extended time of period after an alarm. It is 5 seconds–30 seconds.
- **Period:** The period for using white light. When an alarm triggered during the configured period, the system links white light. For the configuration, see "5.1.1.1 Setting Period."

Figure 5-7 White light linkage

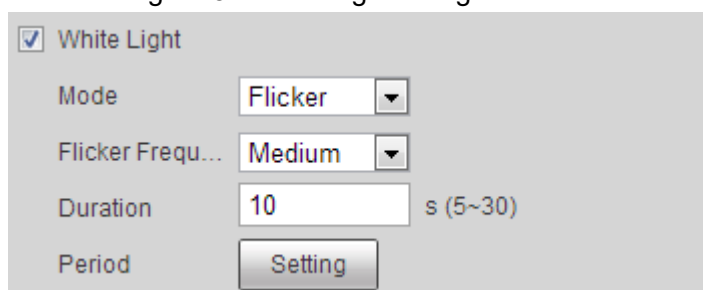

A screenshot of a user interface element for White Light linkage. It features a checked checkbox labeled "White Light". Below it are four configuration fields: "Mode" with a dropdown menu set to "Flicker", "Flicker Frequ..." with a dropdown menu set to "Medium", "Duration" with a text input field containing "10" and a range indicator "s (5~30)", and "Period" with a button labeled "Setting".

5.1.1.8 Audio Linkage

The system broadcasts alarm audio file when an alarm event occurs. Select **Setting > Camera > Audio > Alarm Audio** to set alarm audio file.

Figure 5-8 Audio linkage

5.1.2 Subscribing Alarm

5.1.2.1 About Alarm Types

For alarm types and preparations of alarm events, see Table 5-2.

Table 5-2 Description of alarm types

Alarm Type	Description	Preparation
Motion Detection	The alarm is triggered when moving object is detected.	Motion detection is enabled. For details, see "5.4.1 Setting Motion Detection."
Disk Full	The alarm is triggered when the free space of SD card is less than the set value.	The SD card no space function is enabled. For details, see "5.18.1 Setting SD Card."
Disk Error	The alarm is triggered when there is failure or malfunction in the SD card.	SD card failure detection is enabled. For details, see "5.18.1 Setting SD Card."
Video Tampering	The alarm is triggered when the camera lens is covered or there is defocus in video images.	Video tampering is enabled. For details, see "5.4.2 Setting Video Tamper."
External Alarm	The alarm is triggered when there is external alarm input.	The device has alarm input port and external alarm function is enabled. For details, see "5.17 Setting Relay-in."
Illegal Access	The alarm is triggered when the number of consecutive login password error is up to the allowable number.	Illegal access detection is enabled. For details, see "5.18.3 Setting Illegal ."
Audio Detection	The alarm is triggered when there is audio connection problem.	Abnormal audio detection is enabled. For details, see "5.5 Setting Smart Motion Detection."
IVS	The alarm is triggered when intelligent rule is triggered.	Enable IVS, crowd map, face detection or people counting, and other intelligent functions.

Alarm Type	Description	Preparation
Scene Changing	The alarm is triggered when the device monitoring scene changes.	Scene changing detection is enabled. For details, see "5.4.3 Setting Scene Changing."
Voltage Detection	The alarm is triggered when the device detects abnormal voltage input.	Voltage detection is enabled. For details, see "5.18.4 Setting Voltage Detection."
Security Exception	The alarm is triggered when the device detects malicious attack.	Voltage detection is enabled. For details, see "5.18.5 Setting Security Exception."

5.1.2.2 Subscribing Alarm Information

You can subscribe alarm event. When a subscribed alarm event is triggered, the system records detailed alarm information at the right side of the interface.



Functions of different devices might vary, and the actual product shall prevail.

Step 1 Click the **Alarm** tab.

The **Alarm** interface is displayed. See Figure 5-9.

Figure 5-9 Alarm (subscription)

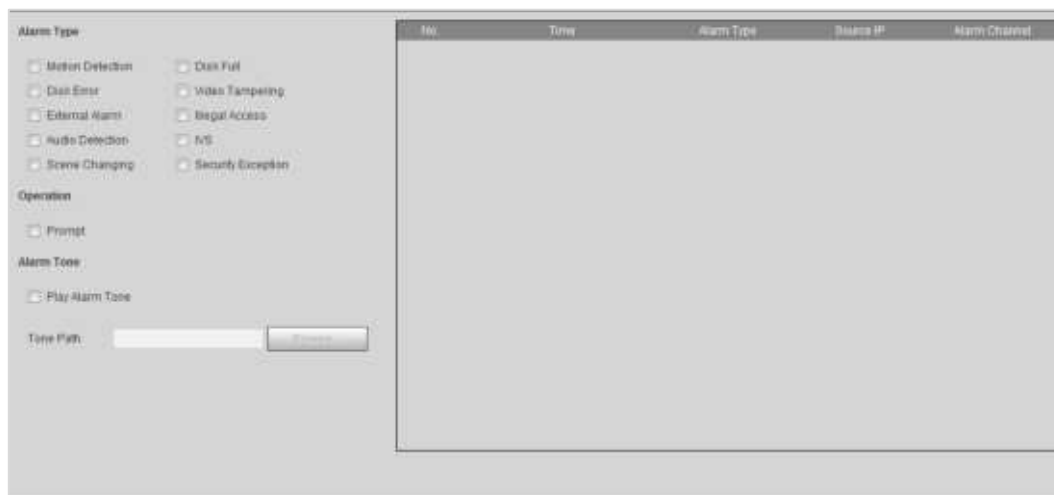

Step 2 Select **Alarm Type** according to the actual need. For details, see Table 5-2.

- Select **Prompt**. The system prompts and records alarm information according to actual conditions.
 - ◇ When the subscribed alarm event is triggered and the **Alarm** interface is not displayed, the  is displayed on the **Alarm** tab and the alarm information is recorded automatically. Click the **Alarm** tab, and this icon disappears.
 - ◇ When the subscribed alarm event is triggered and the **Alarm** interface is displayed, the corresponding alarm information is displayed in the alarm list at the right side of the **Alarm** interface.

- Select **Play Alarm Tone**, and select the tone path.
The system would play the selected audio file when the selected alarm is triggered.

5.2 Setting Smart Track

After setting calibration and parameters for smart track, the tracking speed dome can automatically link to a corresponding position and tracks an object till it is out of the object is beyond the monitoring range or the set tracking time is reached when the intelligent rules for panoramic camera triggers an alarm.

5.2.1 Setting Calibration Parameters for Smart Track

The camera has calibration parameters by default, and you can modify the parameters manually when the effect is not good with default setting.

Step 1 Select **Setting > Event > Smart Track > Smart Track**.

The **Smart Track** interface is displayed. See Figure 5-10.

Figure 5-10 Smart track



Step 2 Select scene number under the video images in turns (See Figure 5-11) to add calibration points on the video images of the corresponding scene. Scene numbers 1 to 4 are four splitting scenes of spliced image, and at least add four calibration points on each scene.

Figure 5-11 Selecting scene number



Add calibration points according to the following procedure.

- 1) Adjust the video image of the speed dome to a position aligned with the panoramic image, and then click .

Calibration box is displayed in the images of speed dome and panoramic camera.

- 2) Drag the calibration box to a proper position, and click  to save one pair of calibration boxes.

After the calibration record is saved, the calibration box is displayed in yellow.

Step 3 Click **Save**.

5.2.2 Enabling Alarm Track

Alarm Track is disabled by default. Smart Track is enabled only after Alarm Track is enabled and intelligent rules of the panoramic camera. **Smart Track** is supported only when rules of crowd map, intrusion and tripwire are triggered. See "5.8 Setting IVS" and "5.9 Setting Crowd Map."

Step 1 Select **Setting > Event > Smart Track > Alarm Track**.

The **Alarm Track** interface is displayed. See Figure 5-12.

Figure 5-12 Alarm track

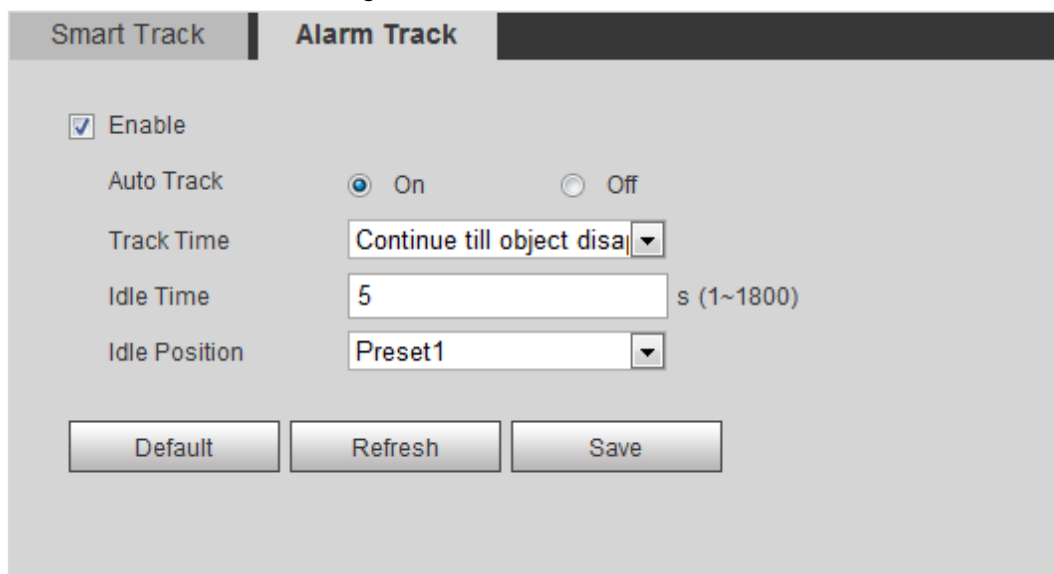

Step 2 To enable track linkage, select the **Enable** check box.

- Manual positioning and manual track are enabled after **Alarm Track** is enabled.
- **Auto Track** is enabled after **Alarm Track** and **Auto Track** are enabled.

Step 3 Set parameters. See Table 5-3.

Table 5-3 Description of alarm track parameters

Parameter	Description
-----------	-------------

Parameter	Description
Auto Track	Select On , the speed dome would automatically links to a corresponding position and tracks an object when the intelligent rules of the panoramic camera trigger alarms.
Track Time	Set the alarm track time. <ul style="list-style-type: none"> Before an object disappears: The speed dome would automatically links to a corresponding position and tracks an object until the object moves out of the monitoring range when the intelligent rules of the panoramic camera trigger alarms. Custom: Set the auto alarm track time of the speed dome.
Idle Time	It is an interval from the end of alarm track of the speed dome to the start of idle mode. Set Idle Time and Idle Position . If no event needs to be tracked after the configured idle time, the device automatically rotates to the set idle position. For example, the Idle Time is set to be five seconds and the Idle Position is set to be preset point 1. When the speed dome does not start tracking after five seconds, it automatically rotates to preset point 1. To set Idle Position , first set a preset point. For preset point, see "4.3.2.1 Preset."
Idle Position	

Step 4 Click **Save**.

5.3 Setting Panoramic Calibration

The device has calibration parameters by default, and you can modify the parameters manually when the effect is not good with default setting. Before manually calibrating a channel, clear all default calibration parameters.

Channel 1 is PTZ camera. You should calibrate the scene coordinates of **Channel 1** and other channels. Take **Channel 2** as an example.

Step 1 Select **Setting > Event > Panoramic Calibration**.

The **Panoramic Calibration** interface is displayed. See Figure 5-13.

Figure 5-13 Panoramic calibration

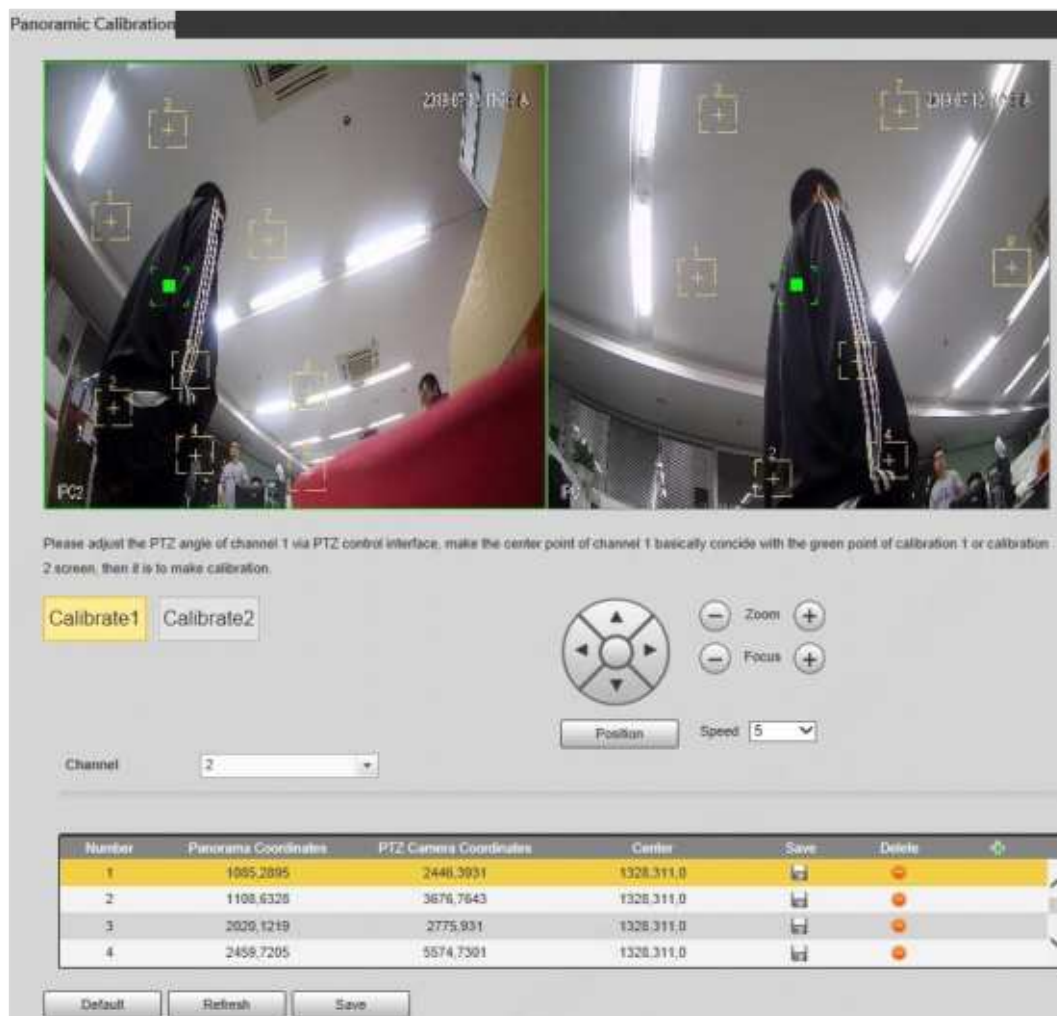

Step 2 Select channel 2, and then select a calibration number under the video images in turns (See Figure 5-14) to add calibration points to the corresponding video images. Take **Calibrate1** as an example.

Figure 5-14 Selecting a calibration number



- 1) Adjust the PTZ angle of channel 1 through the PTZ control interface to rotate the center of channel 1 to a position aligned with the green point in **Calibrate1** image, and then click .

Calibration box is displayed in images of **Channel 1** and **Calibrate1**.

- 2) Respectively drag calibration boxes on images of **Channel 1** and **Calibrate1** to the corresponding positions. Click to save this pair of calibration boxes. You are recommended to drag calibration box to a static position with clear edges in the image. This can ensure the edges can be accurately distinguished by the camera. After the calibration record is saved, the calibration box is displayed in yellow.

Repeat steps 1)–2) to add at least 4 pairs of calibration points to each calibration picture.

Step 3 Click **Save**.

5.4 Setting Video Detection

Check whether there are considerable changes on the video by analyzing video images. In case of any considerable change on the video (such as moving object, fuzzy image), the system performs an alarm linkage.

5.4.1 Setting Motion Detection

The system performs an alarm linkage when the moving object appears on the image and its moving speed reaches the preset sensitivity.



- If you enable motion detection and smart motion detection simultaneously, and configure the linked activities, the linked activities take effect as following:
 - ◇ When Motion Detection is triggered, the camera will record and take snapshots, but other configured linkages such as sending emails, PTZ operation will not take effect.
 - ◇ When Smart Motion Detection is triggered, all the configured linkages take effect.
- If you only enable motion detection, all the configured linkages take effect when motion detection is triggered.

Step 1 Select **Setting > Event > Video Detection > Motion Detection**.

The **Motion Detection** interface is displayed. See Figure 5-15.

Figure 5-15 Motion detection

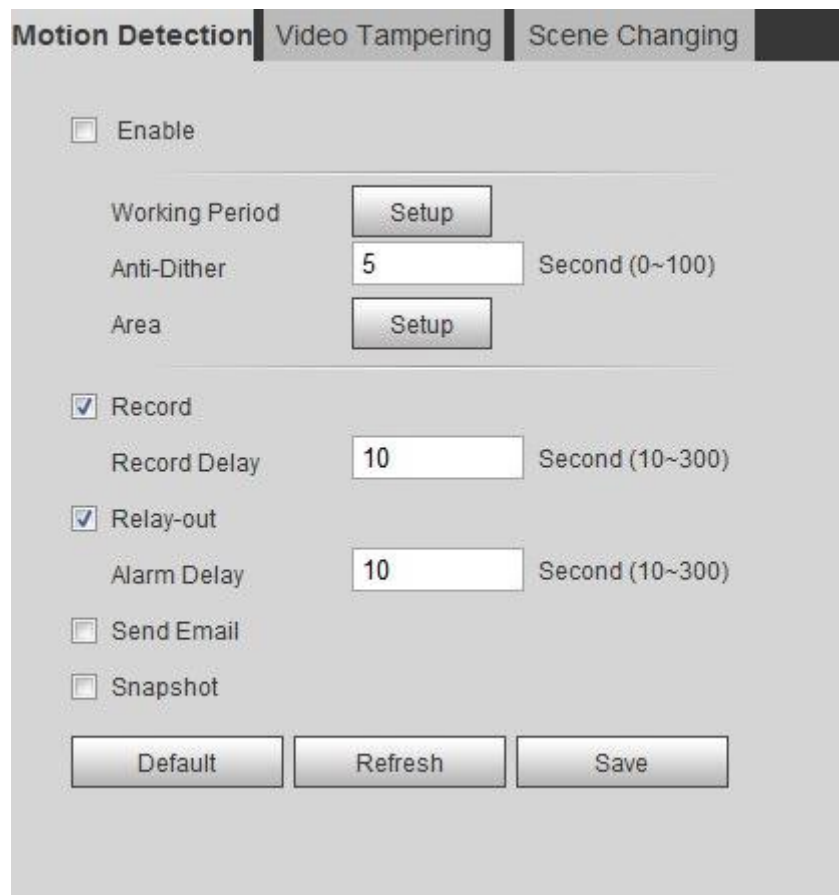

Step 2 Select the **Enable** check box to enable Motion Detection.

Step 3 Set the area for motion detection.

1) Click **Setup** next to **Area**.

The **Area** interface is displayed. See Figure 5-16.

Figure 5-16 Area

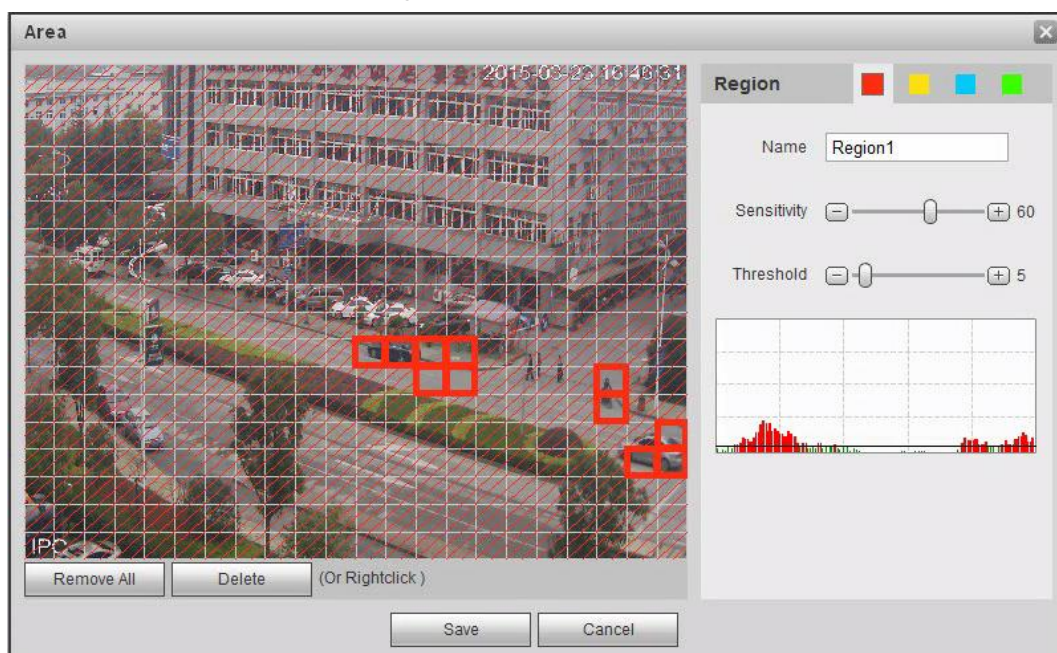

2) Select a color and set the region name. Select an effective area for Motion Detection in the image and set **Sensitivity** and **Threshold**.

- ◇ Select a color on  to set different detection parameters for each region.
- ◇ Sensitivity: Sensitive degree of outside changes. It is easier to trigger the alarm with higher sensitivity.
- ◇ Threshold: Effective area threshold for Motion Detection. The smaller the threshold is, the easier the alarm is triggered.
- ◇ The whole video image is the effective area for Motion Detection by default.
- ◇ The red line in the waveform indicates that the Motion Detection is triggered, and the green one indicates that there is no motion detection. Adjust sensitivity and threshold according to the waveform.

3) Click **Save**.

Step 4 Set arming periods and alarm linkage action. For details, see "5.1.1 Alarm Linkage."
Anti-dither: After the **Anti-dither** time is set, the system only records one motion detection event in the period.

Step 5 Click **Save**.

5.4.2 Setting Video Tamper

The system performs alarm linkage when the lens is covered or video output is mono-color screen caused by light and other reasons.

Step 1 Select **Setting > Event > Video Detection > Video Tamper**.

The **Video Tamper** interface is displayed. See Figure 5-17.

Figure 5-17 Video tampering

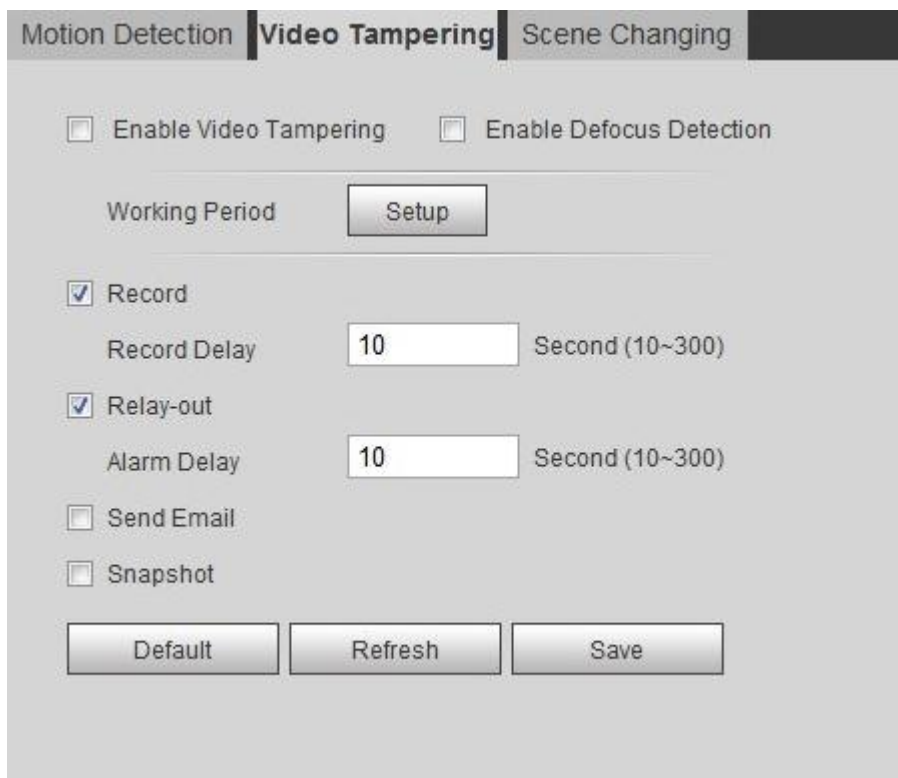

Step 2 Select the **Enable Video Tampering** check box, and set arming periods and alarm linkage action. For details, see "5.1.1 Alarm Linkage."

Select the **Enable Defocus Detection** check box: The alarm is triggered when the image is fuzzy. This function is available on some select models.

Step 3 Click **Save**.

5.4.3 Setting Scene Changing

The system performs alarm linkage when the image switches from the current scene to another one.

Step 1 Select **Setting > Event > Video Detection > Scene Changing**.

The **Scene Changing** interface is displayed. See Figure 5-18.

Figure 5-18 Scene changing

Step 2 Set arming periods and alarm linkage action. For details, see "5.1.1 Alarm Linkage."

Step 3 Click **Save**.

5.5 Setting Smart Motion Detection

The system performs alarm linkage when human, non-motorized vehicle, or motor vehicle appear on the image and its moving speed reaches the preset sensitivity. Enabling smart motion detection can avoid the alarms triggered by the environment changes, and the function is enabled by default.

Preparation

- Select **Setting > Event > Video Detection > Motion Detection** to enable Motion Detection.

- You have set **Period** and **Area** in **Motion Detection**, and make sure that the sensitivity value is larger than 0, and the threshold value is smaller than 100.

Procedure

Step 1 Select **Setting > Event > Smart Motion Detection**.

The **Smart Motion Detection** interface is displayed. See Figure 5-19.

Figure 5-19 Smart motion detection

Step 2 Select the **Enable** check box to enable smart motion detection function.

Step 3 Set effective object and sensitivity.

- Effective object: Includes **Human** and **Motor vehicle**. When you select **Human**, the camera will detect human and non-motorized vehicle.
- Sensitivity: Includes **Low**, **Middle**, and **High**. The higher the sensitivity is, the easier the alarm will be triggered.

Step 4 Click **OK**.

5.6 Setting Audio Detection

The system performs alarm linkage when vague voice, tone change, or sound intensity rapid change is detected.

Step 1 Select **Setting > Event > Audio Detection**.

The **Audio Detection** interface is displayed. See Figure 5-20.

Figure 5-20 Audio detection

Audio Detection

Enable Input Abnormal

Enable Intensity Change

Sensitivity 50

Threshold 50

Working Period

Anti-Dither Second (0~100)

Record

Record Delay Second (10~300)

Relay-out

Alarm Delay Second (10~300)

Send Email

Snapshot

Step 2 Set parameters.

- Input abnormal: Select the **Enable Input Abnormal** check box, and the alarm is triggered when the system detects abnormal sound input.
- Intensity change: Select the **Enable Intensity Change** check box and then set **Sensitivity** and **Threshold**. The alarm is triggered when the system detects that the sound intensity exceeds the set threshold.
 - ◇ It is easier to trigger the alarm with higher sensitivity or smaller threshold. Set a high threshold for noisy environment.
 - ◇ The red line in the waveform indicates audio detection is triggered, and the green one indicates no audio detection. Adjust sensitivity and threshold according to the waveform.

Step 3 Set arming periods and alarm linkage action. For details, see "5.1.1 Alarm Linkage."**Step 4** Click **Save**.











5.7 Setting Smart Plan

Smart plan includes face detection, heat map, IVS, people counting, face detection, video structuralization, and stereo analysis. The intelligent function can be enabled only after the corresponding smart plan is enabled.

Step 1 Select **Setting > Event > Smart Plan**.

The **Smart Plan** interface is displayed. For smart plan icon, see Table 5-4.

Table 5-4 Description of smart plan icon

Icon	Description	Icon	Description	Icon	Description
	Face detection		Stereo vision		Heat map
	Stereo analysis		IVS		Face recognition
	People counting		Video Structuralization		Crowd map
	ANPR		-		-

Step 2 Enable smart functions as need.

Different cameras support different ways to enable smart functions. Select corresponding ways to enable these functions according to the actual interface.

- Select an icon to enable the corresponding smart plan.
Click an icon to enable it, and the selected smart function is highlighted. Click it again to cancel the selection.

If there is  icon on the interface, click it to enable the smart function switch.

- Enable smart plan through **Add Plan**.
 - 1) Select a preset point from the **Add Plan** the interface.
The smart plan for the point is displayed.
 - 2) To enable a smart function, click the corresponding icon.
The selected smart function is highlighted. Click it again to cancel the selection.

Step 3 Click **Save**.

5.8 Setting IVS

This section introduces scene selection requirements, rule configuration, and global configuration for IVS (intelligent video surveillance).

Basic requirements on scene selection are as follows.

- The target should occupy no more than 10% of the whole image.
- The target size in the image should be no more than 10×10 pixels. The size of abandoned object in the image should be no less than 15×15 pixels (CIF image). The target height and width should no more less than a third of the image height and width. The recommended target height is 10% of the image height.
- The brightness difference of the target and the background should be no less than 10 gray levels.
- The target should be continuously present in the image for no less than two seconds, and the moving distance of the target should be larger than its width and no less than 15 pixels (CIF image) at the same time.
- Reduce the complexity of surveillance scene as much as you can. Intelligent analysis functions are not recommended to be used in scene with dense targets and frequent illumination change.
- Avoid areas such as glass, reflective ground, water surface, and areas interfered by branch, shadow and mosquito. Avoid backlight scene and direct light.

5.8.1 Global Configuration

Set global rules for IVS, including anti-disturb, depth of field calibration, and valid motion parameter for targets.

Calibration Purpose

Determine corresponding relationship between 2D image captured by the camera and 3D actual object according to one horizontal ruler and three vertical rulers calibrated by the user and the corresponding actual distance.

Applicable Scene

- Medium or distant view with installation height of more than three meters. Scenes with parallel view or ceiling-mounted are not supported.
- Calibrate horizontal plane, not vertical walls or sloping surfaces.
- This function is not applicable to scenes with distorted view, such as the distorted views captured by super wide-angle or fisheye camera.

Notes

- Calibration Drawing
 - ◇ Calibration area: The calibration area drawn should be on one horizontal plane.
 - ◇ Vertical ruler: The bottom of three vertical rulers should be on the same horizontal plane. Select three reference objects with fixed height in triangular distribution as vertical rulers, such as vehicle parked at roadside or road lamp poles. Arrange three persons to draw at each of the three positions in the monitoring scene.
 - ◇ Horizontal ruler: Select reference object with known length on the ground, such as sign on the road, or use a tape to measure the actual length.
- Calibration Verification

After setting the ruler, draw a straight line on the image, check the estimated value of the straight line, and then compare this value with the value measured in the actual scene to verify calibration accuracy. In case of major difference between the estimated value and the actual one, fine-tune or reset parameters until the error requirement is met.

Procedure

Step 1 Select **Setting > Event > IVS > Global Setup**.

The **Global Setup** interface is displayed. See Figure 5-21.

Figure 5-21 Global setup of IVS

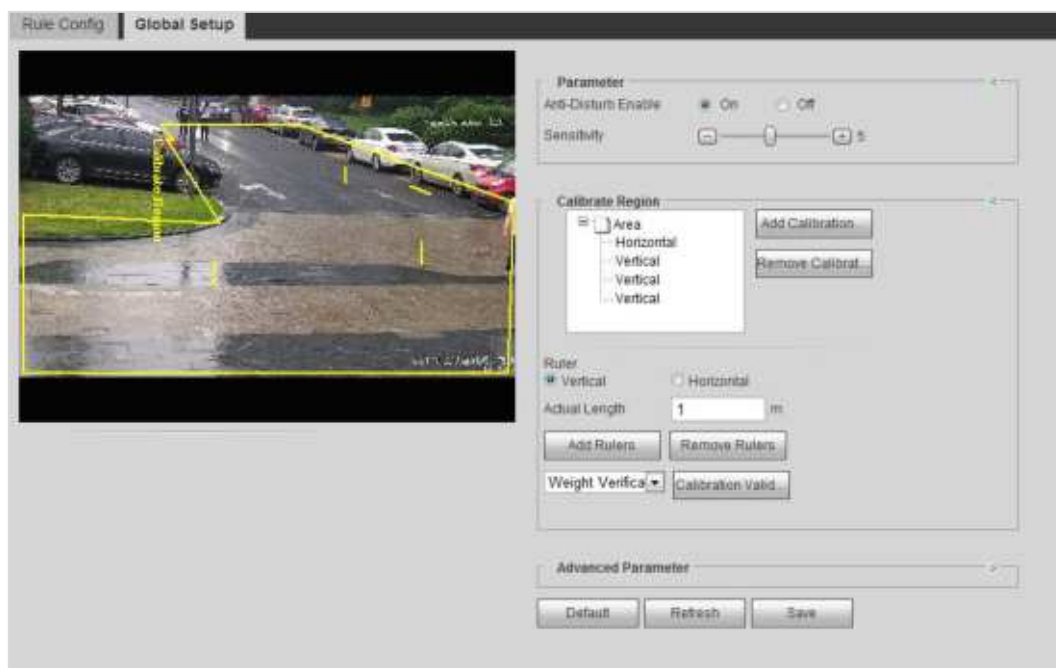

Step 2 Set parameters. See Table 5-5.

Table 5-5 Description of global setup (IVS) parameters

Parameter	Description
Anti-Disturb Enable	A reserved function.
Sensitivity	Adjust the filter sensitivity. With higher value, it is easier to trigger an alarm when low-contrast object and small object are captured, and the false detection rate is higher.
Tracking Overlap Rate	A reserved function.
Valid Tracking Distance	A reserved function.
Valid Tracking Time	A reserved function.

Step 3 Set calibration area and ruler.

- 1) Click **Add Calibration Area** and draw a calibration area in the image.
- 2) Select a calibration type and enter the actual length, and then click **Add Rulers**.
- 3) Draw one horizontal ruler and three vertical rulers in the calibration area.

Step 4 Click **Save**.

Verification

Step 1 Select the verification type, and then click **Calibration Valid**.

To verify vertical ruler and horizontal ruler, respectively select **Height Verification** and **Width Verification**.

Step 2 Draw a straight line in the image to verify whether the rulers are correctly set.

In case of big difference between the estimated value and the actual one, fine-tune or reset parameters until the error requirement is met.

5.8.2 Rule Configuration

Set rules for IVS, including cross fence detection, tripwire, intrusion, abandoned object, moving object, fast moving, parking detection, crowd gathering, and loitering detection.

For the functions and applications of the rules, see Table 5-6.

Table 5-6 Description of IVS functions

Rule	Description	Applicable Scene
Tripwire	When the target crosses tripwire from the defined motion direction, the system performs alarm linkages.	Scenes with sparse targets and no occlusion among targets, such as the perimeter protection of unattended area.
Intrusion	When the target enters, leaves, or appears in the detection area, the system performs alarm linkages.	
Abandoned object	When an object is abandoned in the detection area over the set time, the system performs alarm linkages.	Scenes with sparse targets and without obvious and frequent light change. Simple scene in the detection area is recommended. <ul style="list-style-type: none"> Missed alarm might increase in the scenes with dense targets, frequent occlusion, and people staying. In scenes with complex foreground and background, false alarm might be triggered for abandoned or missing object.
Missing object	When an object is taken out of the detection area over the defined time, the system performs alarm linkages.	
Fast moving	When the motion speed is higher than the configured speed, the system performs alarm linkages.	Scene with sparse targets and less occlusion. The camera should be installed right above the monitoring area. The light direction should be vertical to the motion direction.
Parking detection	When the target stays over the configured time, the system performs alarm linkages.	Road monitoring and traffic management.

Rule	Description	Applicable Scene
Crowd gathering	When the crowd gathers or the crowd density is large, the system performs alarm linkages.	Scenes with medium or long distance, such as outdoor plaza, government entrance, station entrance and exit. It is not suitable for short-distance view analysis.
Loitering detection	When the target loiters over the shortest alarm time, the system performs alarm linkages. After alarm is triggered, if the target stay in the area within the time interval of alarm, then alarm will be triggered again.	Scenes such as park and hall.

Preparation

- Select **Setting > Event > Smart Plan**, and enable **IVS**.
- Select **Setting > Event > IVS > Global Setup** to finish global configuration, and then configure **Fast Moving** rule.

Procedure

Configure IVS rules. This section takes tripwire as an example.



Go to the **Rule Config** interface of the speed dome, and the PTZ lock function is automatically enabled. The locking time is 180 seconds. You can only manually control the PTZ during the locking time. Click **Unlock** at lower left corner of the **Rule Config** interface to manually unlock the PTZ, and click **Lock** again to relock the PTZ.

Step 1 Select **Setting > Event > IVS > Rule Config**.

The **Rule Config** interface is displayed.

Step 2 Click , double-click the name to modify the rule name, and select **Tripwire** from the **Rule Type** drop-down list. See Figure 5-22.

Figure 5-22 Tripwire



- Step 3** Click **Draw Rule** to draw rule line in the image. Right-click to finish drawing.
For requirements of drawing rules, see Table 5-7. After drawing rules, drag corners of the detection area to adjust the area range.

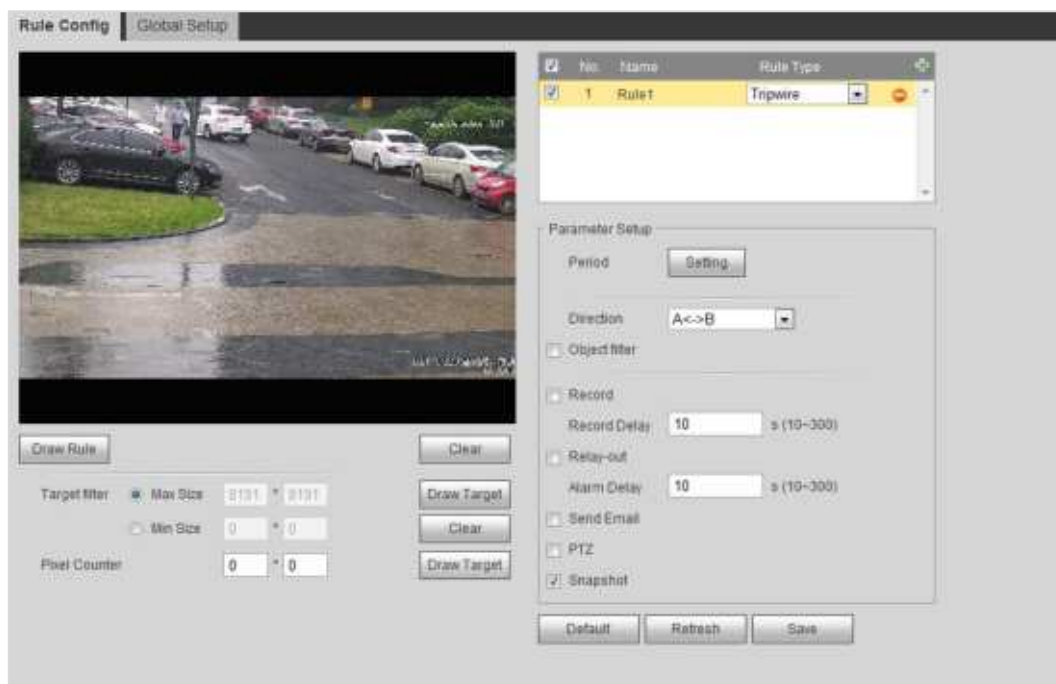

Table 5-7 Description of IVS analysis

Rule	Description
Tripwire	Draw a detection line.
Intrusion	Draw a detection area.
Abandoned object	<ul style="list-style-type: none"> During the detection of abandoned object, the alarm is also triggered if pedestrian or vehicle stays for a long time. If the abandoned object is smaller than pedestrian and vehicle, set the target size to filter pedestrian and vehicle or properly extend the duration to avoid false alarm triggered by transient staying of pedestrian.
Missing object	
Fast moving	
Parking detection	
Crowd gathering	<ul style="list-style-type: none"> During the detection of crowd gathering, false alarm might be triggered by low installation height, large percentage of single person in an image or obvious target occlusion, continuous shaking of the camera, shaking of leaves and tree shade, frequent opening or closing of retractable door, or dense traffic or people flow.
Loitering detection	

- Step 4** (Optional) Click **Draw Target** at the right side of **Target Filter**, and then draw the target in the image.
- When the rule of crowd gathering is configured, you do not need to set target filter, but draw the minimum gathering area. Click **Draw Target** to draw the minimum gathering area in the scene. The alarm is triggered when the number of people in the detection area exceeds the minimum area and the duration.
 - Click **Clear** to delete all drawn detection lines.
 - Click **Draw Target** at the right side of **Pixel Counter**, and then press and hold the left mouse button to draw a rectangle, the **Pixel Counter** then displays its pixel.

- Step 5** Set rule parameters for IVS. For details, see Table 5-8.

Table 5-8 Description of IVS parameters

Parameter	Description
Direction	<p>Set the direction of rule detection.</p> <ul style="list-style-type: none"> When setting cross fence detection and tripwire, select A->B, B->A or A<->B When setting intrusion, select Enters, Exits, or Enter&Exit.
Action	When setting intrusion action, select Appears or Cross .
Object tracking	<p>Select Object Tracking to enable this function. When alarm is triggered by a moving object, select 1P+3 or 1P+5 as the object tracking display mode in the Live interface. Then the tracking scene follows the moving object until the object is out of the camera range. For details, see "4.2.4 Window Adjustment Bar."</p>  <p>This function is available on some select models.</p>
Track linkage	<p>Select Alarm Track and set the tracking time. When alarm is triggered, the camera automatically tracks the person or object that triggers the alarm. Tracking time is the duration that the camera automatically tracks the object.</p> 
Track Time	<p>Before enabling this function, you need to enable or disable the Alarm Track function under Smart Track as needed.</p> <ul style="list-style-type: none"> When the Channel is set as 1, disable Alarm Track under Smart Track. When the Channel is set as 2 or 3, enable Alarm Track under Smart Track.
AI Recognition	<p>Select AI Recognition to enable this function.</p> <ul style="list-style-type: none"> When you select Person as the alarm target, an alarm will be triggered when the system detects that persons trigger the rule. When you select Vehicle as the alarm target, alarm will be triggered when the system detects that vehicle trigger the rule.
Duration	<ul style="list-style-type: none"> For abandoned object, the duration is the shortest time for triggering an alarm after an object is abandoned. For missing object, the duration is the shortest time for triggering an alarm after an object is missing. For parking detection, crowd gathering, or loitering detection, the duration is the shortest time for triggering an alarm after an object appears in the area.
Sensitivity	<ul style="list-style-type: none"> For fast moving, sensitivity is related to the triggering speed. Lower sensitivity requires faster moving speed to trigger the alarm. For crowd gathering, sensitivity is related to the alarm triggering time. It is easier to trigger the alarm with higher sensitivity.

Step 6 Set arming periods and alarm linkage action. For details, see "5.1.1 Alarm Linkage."

Step 7 Click **Save**.

To view alarm information on the **Alarm** tab, you need to subscribe relevant alarm event. For details, see "5.1.2 Subscribing Alarm."

5.9 Setting Crowd Map

You can view crowd distribution on the map in real time for timely arming, to prevent stampede and other accidents.

5.9.1 Global Configuration

Set calibration parameters of panoramic camera.

Calibration Purpose

Determine corresponding relationship between 2D image captured by the camera and 3D actual object according to the rulers calibrated by the user and its corresponding actual distance.

Notes

Draw two rulers at a position close to and a position far away from the center area in the image to ensure small difference between actual vertical distance and the calibrated one of each point in the image after calibration. It is recommended to arrange two persons to draw at each of the two positions in the monitoring scene.

Procedure

Step 1 Select **Setting > Event > Crowd Map > Global Setup**.

The **Global Setup** interface is displayed. See Figure 5-23.

Figure 5-23 Global setup (crowd map)



Step 2 Click **Add Rulers 1** and **Add Rulers 2** to respectively draw a ruler in the area.

Step 3 Enter the installation height and the actual length according to the actual situation.

Step 4 Click **Save**.

5.9.2 Rule Configuration

When the number of people or the crowd density in the detection area exceeds the configured threshold, the system performs alarm linkages.

Preparation

- Select **Setting > Event > Smart Plan**, and enable **Crowd Map**.
- Select **Setting > Event > Crowd Map > Global Setup** to configure the crowd map.

Procedure

Step 1 Select **Setting > Event > Crowd Map > Crowd Map**.

The **Crowd Map** interface is displayed. See Figure 5-24.

Figure 5-24 Crowd map

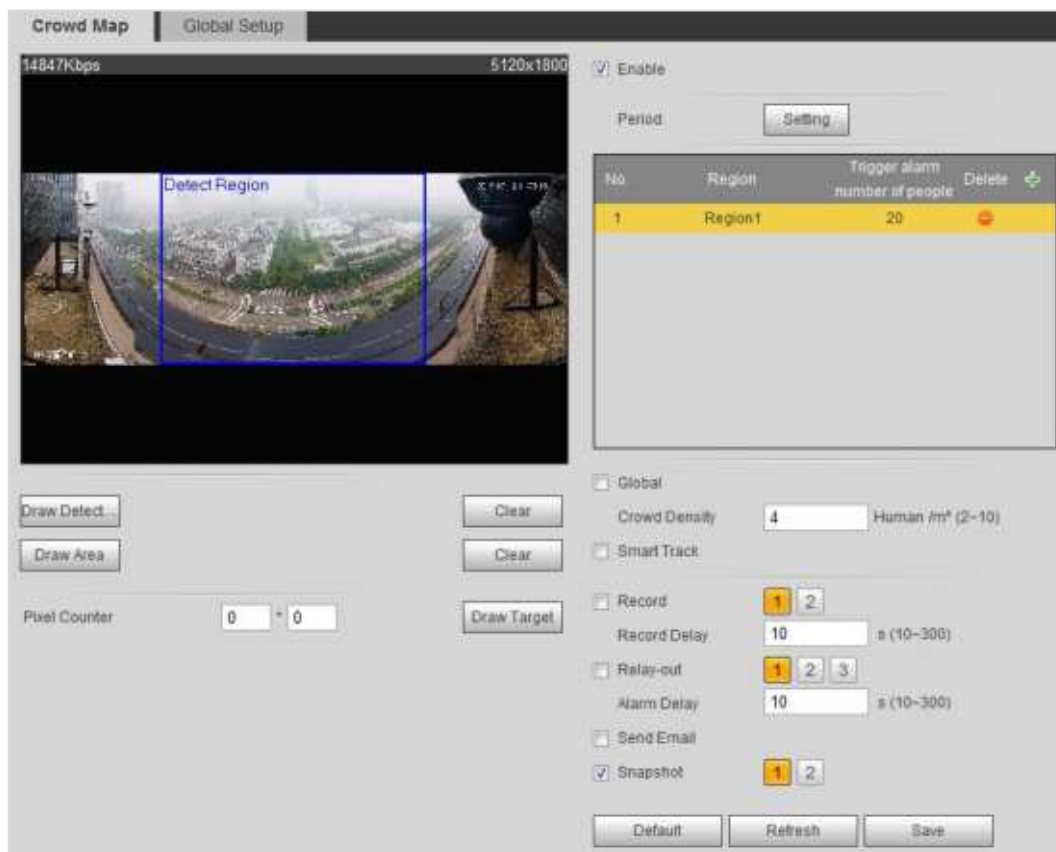

Step 2 Select the **Enable** check box, and then the crowd map function is enabled.

Step 3 Click **Draw Detection Area** to draw global area for detecting crowd distribution in the image.

After drawing a global area, you can draw multiple local statistical areas in the global area as needed.

- 1) Click , and then click **Draw Area** to draw local statistical area in global detection area.

You can draw up to eight local statistical areas.

- 2) Double-click the area name and the alarm people amount to set the area name of local statistical area and the threshold of the alarm people amount.

When the number of people in the statistical area exceeds the alarm people amount, the system performs alarm linkages. The default alarm people amount is 20.

Step 4 Set parameters. See Table 5-9.

Table 5-9 Description of crowd map parameters

Parameter	Description
Global	Select the Global check box and set the crowd density threshold. The system detects crowd distribution in the global area. When the crowd density exceeds the configured threshold, the system performs alarm linkages.
Crowd Density	

Parameter	Description
Smart track	<p>Select the Smart Track check box, and when alarm is triggered by the panoramic camera, the speed dome automatically turns to the position where alarm is triggered. The tracking time is "idle time + five seconds." For the details of idle time configuration, see "5.2.2 Enabling Alarm Track."</p> <p>Linkage rules:</p> <ul style="list-style-type: none"> • Detect global alarm only: Turns to crowd with highest density. • Detect local alarm only: Turns to local area that triggers alarm first. • Detect global alarm + one local alarm: First turns to local area, and then the crowd with highest density when there is no alarm in local area. • Detect global alarm + multiple local alarms: First turns to local area that triggers alarm first, and then the crowd with highest density when there is no alarm in local area. <p></p> <p>Before enabling this function, you need to configure Smart Track. For details, see "5.2 Setting Smart Track."</p>
Pixel Counter	<p>Click Draw Target next to Pixel Counter, and then press and hold the left mouse button to draw a rectangle, the Pixel Counter then displays its pixel.</p>

Step 5 Set arming periods and alarm linkage actions. For details, see "5.1.1 Alarm Linkage."

Step 6 Click **Save**.

Verification

Click  on the **Live** interface to view the crowd map. See Figure 5-25.

Figure 5-25 Crowd map (1)



Double-click the rendering area at the lower-right corner in the image to view crowd distribution in the area. See Figure 5-26.

Figure 5-26 Crowd map (2)



5.10 Setting Face Recognition

When a face is detected or recognized in the detection area, the system performs alarm linkage and supports searching face detection and recognition results.

- **Face Detection:** When a face is detected in the area, the system performs alarm linkage, such as recording and sending emails.
- **Face Recognition:** When a face is detected in the area, the system compares the captured face image with the information in the face database, and links alarm according to the comparison result.

For the process of setting face recognition, see Figure 5-27.

Figure 5-27 Face recognition flowchart

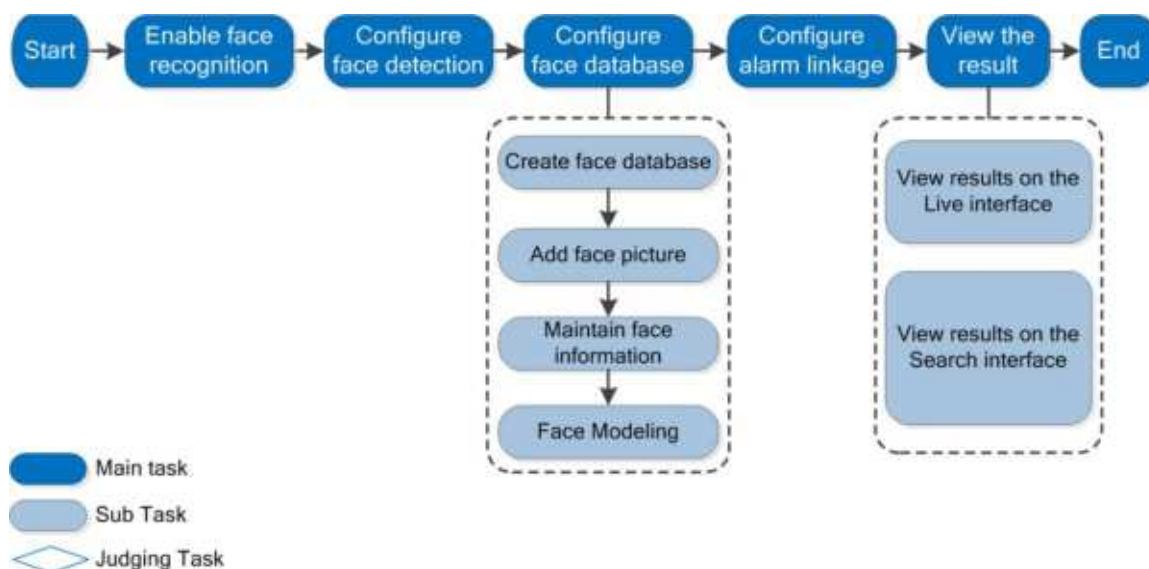

5.10.1 Setting Face Detection

When a face is recognized in the detection area, the system performs alarm linkage.

Preparation

Enable **Face Recognition** from **Setting > Event > Smart Plan**.

Procedure

Step 1 Select **Setting > Event > Face Recognition > Face Detection**.

The **Face Detection** interface is displayed. See Figure 5-28.

Figure 5-28 Face detection

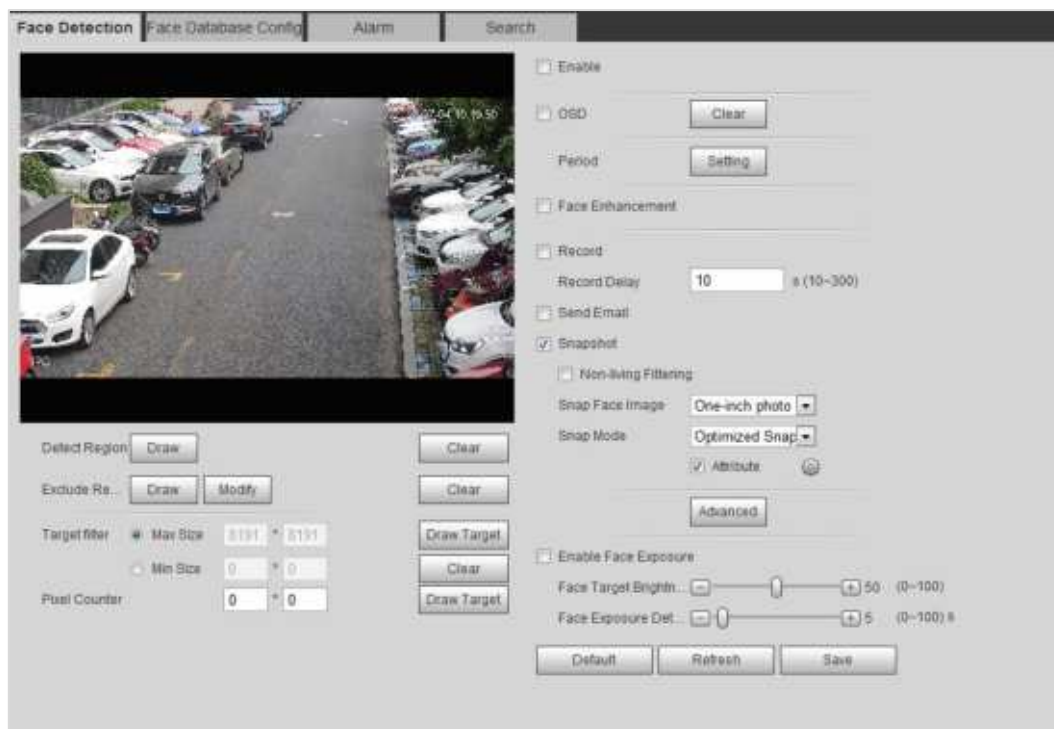

Step 2 Select the **Enable** check box to enable the face detection function.

Step 3 (Optional) Click **Draw** next to **Detect Region** to draw a face detection area in the image.



Step 4 (Optional) Click **Draw** next to **Exclude Region** to draw a non-face detection area in the **Detect Region**.

Step 5 (Optional) Select **Max Size** or **Min Size**, click **Draw Target** at the right side of **Target filter**, and then draw the target in the image.

Step 6 Set parameters. See Table 5-10.

Table 5-10 Description of face detection parameters

Parameter	Description
OSD	Select the OSD check box, and the number of people with face detected and recognized is displayed on the Live interface. Click Reset to recount.
Face Enhancement	Select the Face Enhancement check box to preferably guarantee clear face with low stream.
Non-living Filtering	Filter non-living faces in the image, such as a face picture.
Snap Face Image	Set a range for snapping face image, including face picture and one-inch picture.

Parameter	Description
Snap Mode	<ul style="list-style-type: none"> ● Optimized Snapshot: Capture the clearest picture within the configured time after the camera detects face. ● Recognition Priority: Repeatedly compare the captured face to the faces in the armed face database, and capture the most similar face image and send the alarm. It is recommended to use this mode in access control scene.  <p>Click Advanced to set the optimized time.</p>
Attribute	Select the Attribute check box, and click  to set the display of face attribute during the face detection.
Advanced	<ul style="list-style-type: none"> ● Snapshot Angle Filter: Set snapshot angle to be filtered during the face detection. ● Snapshot Sensitivity: Set snapshot sensitivity during the face detection. It is easier to detect face with higher sensitivity. ● Optimized Time: Set a time period to capture the clearest picture after the camera detects face.
Enable Face Exposure	Select the Enable Face Exposure check box. When a face is detected, the camera can enhance brightness of the face to make the face image clear.
Face Target Brightness	Set the face target brightness. It is 50 by default.
Face Exposure Detection Interval	Set the face exposure detection interval to prevent image flickering caused by constant adjustment of face exposure. It is five seconds by default.
Pixel Counter	Click Draw Target next to Pixel Counter , and then press and hold the left mouse button to draw a rectangle, the Pixel Counter then displays its pixel.

[Step 7](#) Set arming periods and alarm linkage actions. For details, see "5.1.1 Alarm Linkage."

[Step 8](#) Click **Save**.

5.10.2 Setting Face Database

By setting face database, the face database information can be used to compare with the face detected.

Face database configuration includes creating face database, adding face picture, and face modeling.

5.10.2.1 Creating Face Database

Face database includes face picture, face data and other information. It also provides comparison data for the captured face pictures.

[Step 1](#) Select **Setting > Event > Face Recognition > Face Database Config**.

The **Face Database Config** interface is displayed. See Figure 5-29.
Capacity Limit: Shows the usage of the memory.

Figure 5-29 Face database configuration



Step 2 Click **Add Face Database**.

The **Add Face Database** interface is displayed. See Figure 5-30.

Figure 5-30 Add face database

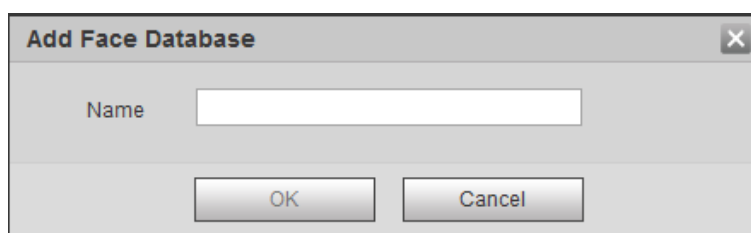

Step 3 Set the name of the face database.

Step 4 Click **OK**. See Figure 5-31.

Figure 5-31 Face database successfully added

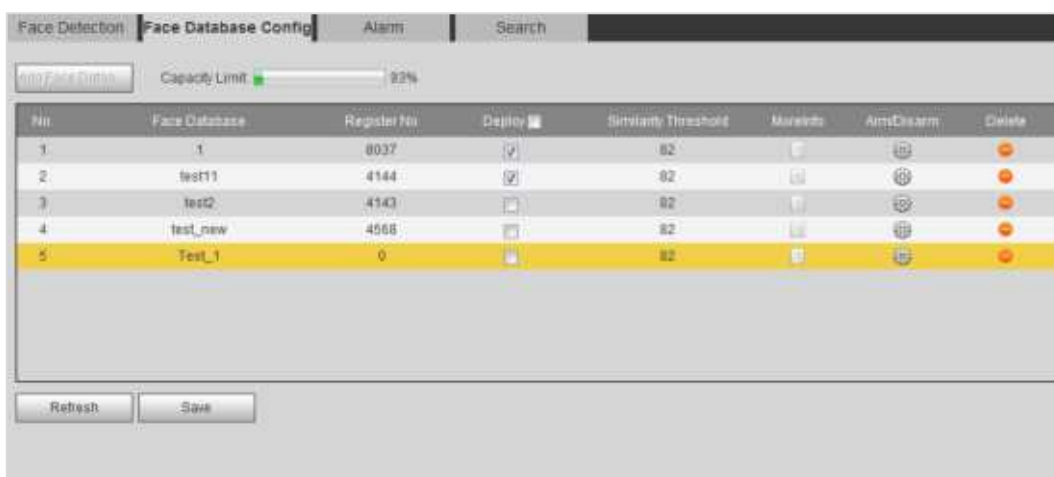

Step 5 Set parameters. See Table 5-11.

Table 5-11 Description of face database parameters

Parameter	Description
Deploy	Select the Deploy check box, and the face database deployment is enabled. The captured face picture is compared to the armed face database.

Parameter	Description
Similarity Threshold	The detected face matches the face database only when the similarity between the detected face and the face feature in face database reaches the configured similarity threshold. After successful match, the comparison result is displayed on the Live interface.
MoreInfo	Click MoreInfo to manage face database. You can search face images by setting search conditions, register personnel, and modify personnel information.
Arm/Disarm	Set the alarm time period. Alarm event will be triggered only within the defined time. See "5.1.1.1 Setting Period."
Delete	Delete the selected face database.

5.10.2.2 Adding Face Picture

Add face picture to the created face database. Single adding and batch importing are supported.

Requirements on face pictures.

- A single face picture size is 50K–150K in JPEG format. The resolution is less than 1080p.
- Face size is 30%–60% of the whole picture. Pixel should be no less than 100 pixels between the ears.
- Taken in full-face view directly facing the camera without makeup, beautification, glasses, and fringe. Eyebrow, mouth and other face features must be visible.

5.10.2.2.1 Single Adding

Add face pictures one by one. Select this way when you need to add a small number of face pictures.

Step 1 Select **Setting > Event > Face Recognition > Face Database Config**.

The **Face Database Config** interface is displayed.

Step 2 Click  next to the face database to be set.

The **Face Database Config** interface is displayed. See Figure 5-32.

Figure 5-32 Face database configuration



Step 3 Click **Registration**.

The **Registration** interface is displayed. See Figure 5-33.

Figure 5-33 Registration (1)

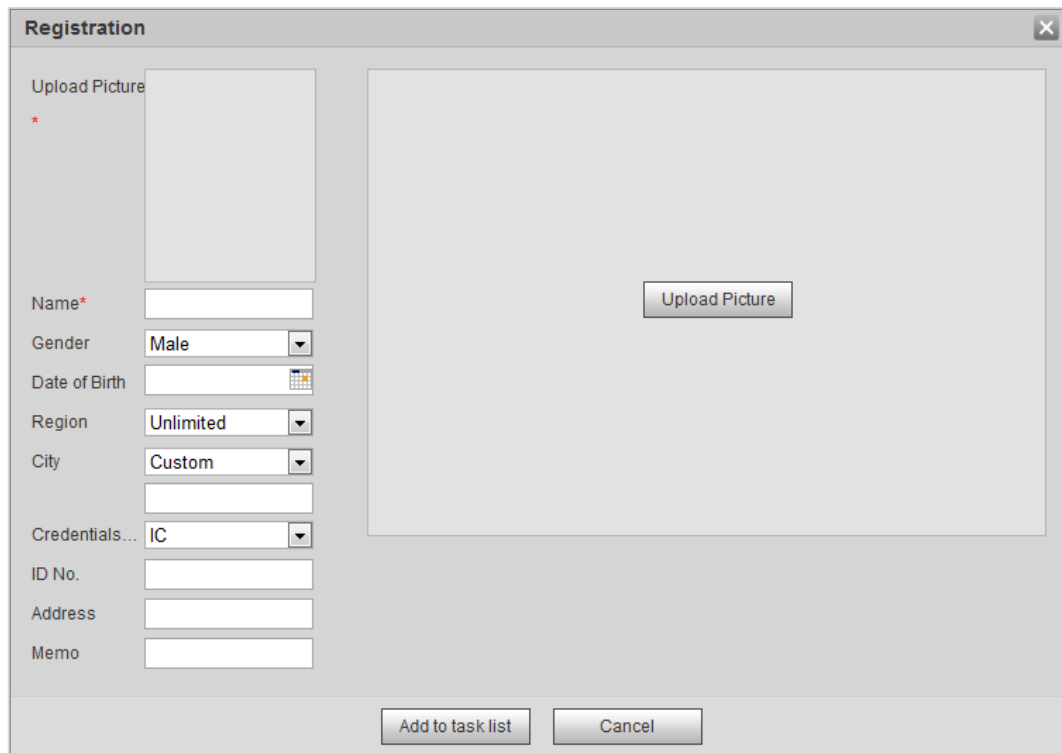
A screenshot of a registration window titled "Registration". The window has a close button in the top right corner. On the left side, there is a vertical list of fields: "Upload Picture" with a red asterisk, "Name*", "Gender" (set to "Male"), "Date of Birth" with a calendar icon, "Region" (set to "Unlimited"), "City" (set to "Custom"), "Credentials..." (set to "IC"), "ID No.", "Address", and "Memo". Each field has a corresponding input box or dropdown menu. On the right side, there is a large, empty rectangular area with a button labeled "Upload Picture" centered within it. At the bottom of the window, there are two buttons: "Add to task list" and "Cancel".

Step 4 Click **Upload Picture**, select a face picture to be uploaded, and click **Open**.
The interface shown as Figure 5-34 is displayed.



You can manually select the area for a face. After uploading picture, box select a face and click **OK**. When there are multiple faces in a photo, select the target face and click **OK** to save face picture.

Figure 5-34 Registration (2)



Step 5 Enter the information about face picture according to the actual situation.

Step 6 Click **Add to task list**.

Step 7 Click **Task List1**, and then click **OK**.

The **Task List** interface is displayed. See Figure 5-35. Click **Remove All** to remove all tasks by one click.

Figure 5-35 Task list (manually add)

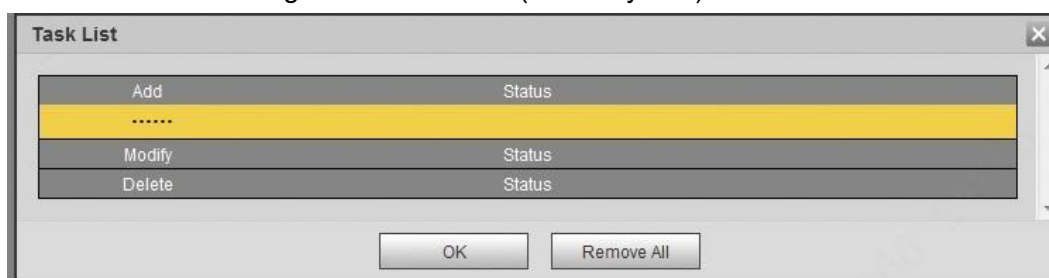

If adding user fails, the error code is displayed on the interface. For details, see Table 5-12. For face modeling operation, see "5.10.2.4 Face Modeling."

Table 5-12 Description of error code

Parameter	Error	Description
0x1134000C	Picture importing error	The picture is too large, and the upper limit is 150K.
0x1134000E		The quality of the added pictures is to the upper limit.
0x11340019		The space of the face database exceeds the upper limit.

Parameter	Error	Description
1	Picture modeling error	The picture format is not correct. Import the picture in JPG format.
2		No face in the picture or the face is not clear. Change the picture.
3		Mutiple faces in the picture. Change the picture
4		Fails to decode the picture. Change the picture.
5		The picture is not suitable to be imported to the face database. Change the picture.
6		The database error. Restart the camera and model faces again.
7		Fails to get the picture. Import the picture again.
8		System error. Restart the camera and model faces again.

5.10.2.2.2 Batch Importing

Import face pictures in batches. Select this way when you need to add a large number of face pictures.

Preparation

Before importing pictures in batches, name face pictures in a format of "Name#SGender#BDate of Birth#NRegion#TCredentials Type#MID No.jpg" (for example, "John#S1#B1990-01-01#T1#M0000). For naming rules, see Table 5-13.



- The max. size of a single face picture is 150K, and the resolution is less than 1080p.
- When naming pictures, Name is required, and others are optional.

Table 5-13 Description of naming rules for batch import parameters

Parameter	Description
Name	Enter a name.
Gender	Enter a figure. "1" is male and "2" female.
Date of Birth	Enter a figure. Format: yyyy-mm-dd, such as 2017-11-23.
Credentials Type	Enter a figure. "1" is ID card and "2" passport.
ID number	Enter ID No..

Procedure

- Step 1** Select **Setting > Event > Face Recognition > Face Database Config**.
The **Face Database Config** interface is displayed.

Step 2 Click  next to the face database that you want to set.

The **Face Database** interface is displayed.

Step 3 Click **Batch Registration**.

The **Task List** interface is displayed. See Figure 5-36.

Figure 5-36 Batch add

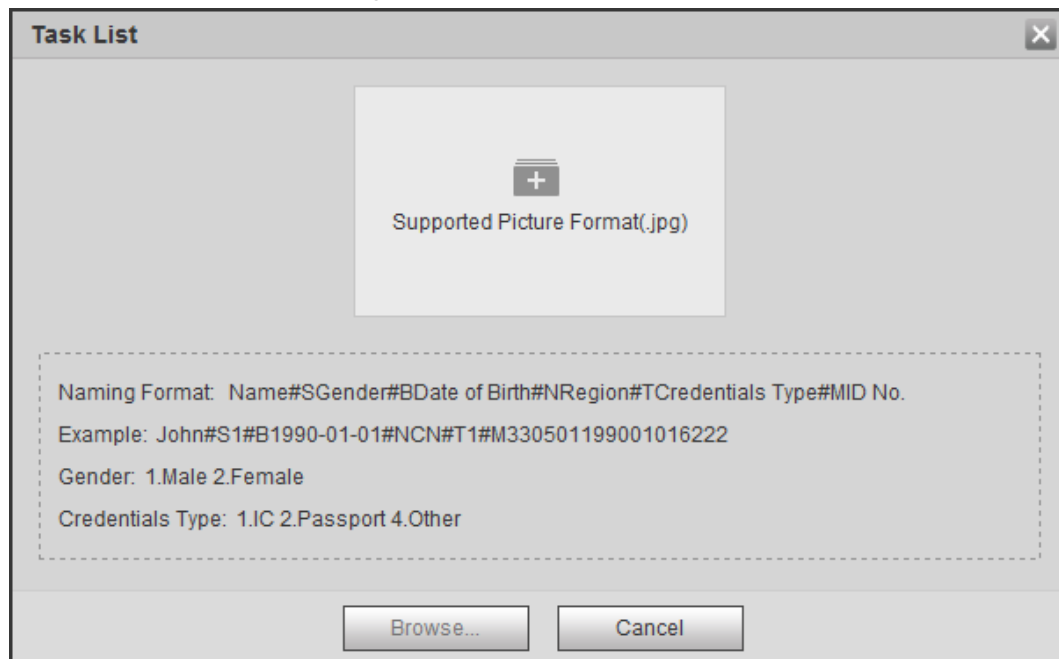

Step 4 Click  to select file path.

Figure 5-37 Batch import

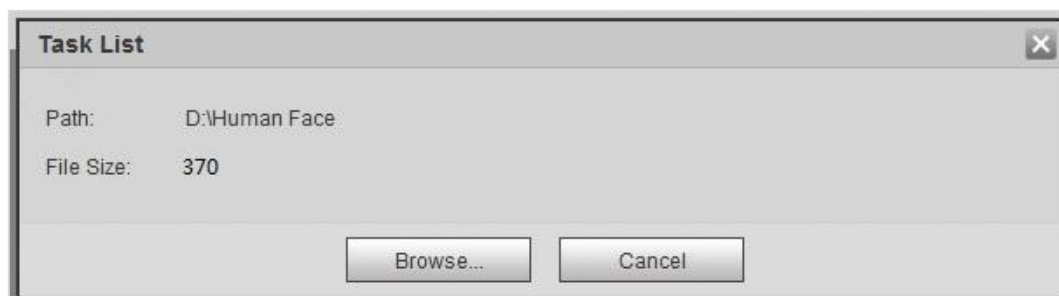

Step 5 Click **Browse**.

The interface shows import process. After finishing the import, the interface shown as Figure 5-38 is displayed.

Figure 5-38 Importing successfully

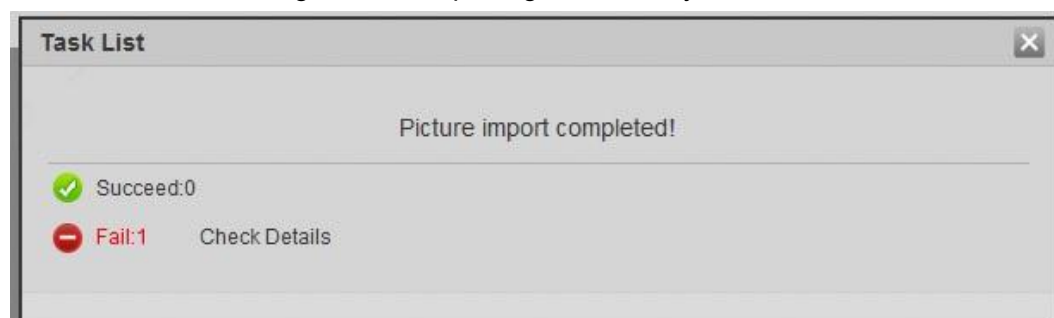



5.10.2.3 Managing Face Picture

Add face pictures to face database, and then manage and maintain face pictures to ensure correct information.

5.10.2.3.1 Modifying Face Information

Step 1 Go to the **Face Database Config** interface, set filtering condition as needed, and click **Search**.

The search result is displayed.

Step 2 Select the row where the face picture or the personnel information is located, and then click  or .

The **Registration** interface is displayed. See Figure 5-39.

Figure 5-39 Face information modification

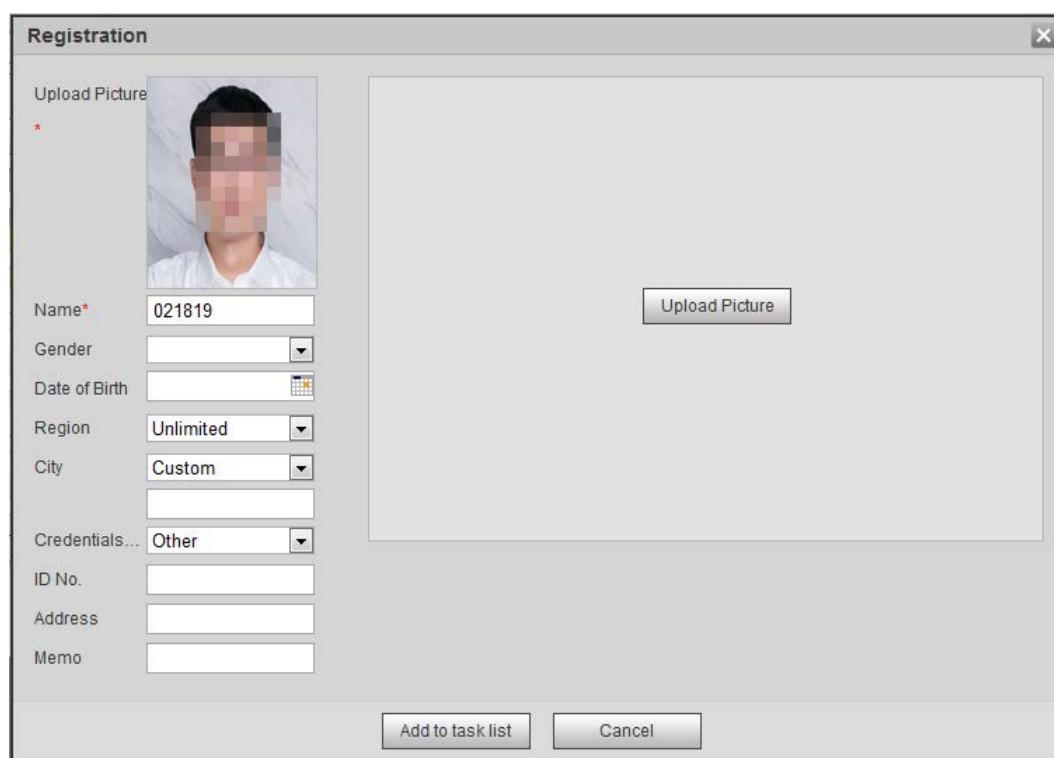



Step 3 Modify face information according to the actual need. Click **Add to task list**.

Step 4 Click , and then click **OK**.

5.10.2.3.2 Deleting Face Picture

Go to the **Face Database Config** Interface, and delete the created face picture.

- Single delete: Select the row where the face picture or the personnel information is located, and click  or  to delete the face picture.
- Batch delete: Select at the upper right corner of the face picture or of the row

where the personnel information is located. Select the information, click **Add to Deletion List**, , and then click **OK** to delete the selected face picture.

- Delete all: When viewing face pictures in a list, click of the row where the serial number is located; when viewing by thumbnail, select **All** to select all face pictures. Click **Add to Deletion List**, , and then click **OK** to delete all face pictures.

5.10.2.4 Face Modeling

Face modeling extracts face picture information and imports the information to a database to establish relevant face feature models. Through this function, the face recognition and other intelligent detections can be realized.



- The more the selected face pictures are, the longer time the face modeling takes. Please wait patiently.
- During modeling, some intelligent detection functions (such as face recognition) are not available temporarily, and will be available after modeling.

Step 1 Select **Setting > Event > Face Recognition > Face Database Config**.

The **Face Database Config** interface is displayed.

Step 2 Click  next to the face database to be set.

The **Face Database Config** interface is displayed. See Figure 5-40.

Figure 5-40 Face database configuration



Step 3 Start modeling.

- Selective modeling.
If there are many face pictures in the face database, you can set search criteria to select the pictures that need to be modeled.
 - 1) Set the search criteria, and click **Search**.
 - 2) Select the face pictures to be modeled.
 - 3) Click **Modeling**.
- All modeling,
Click **Modeling All** to complete modeling of all face pictures in the face database.

Step 4 View the modeling result.

- For successful modeling, see Figure 5-41.

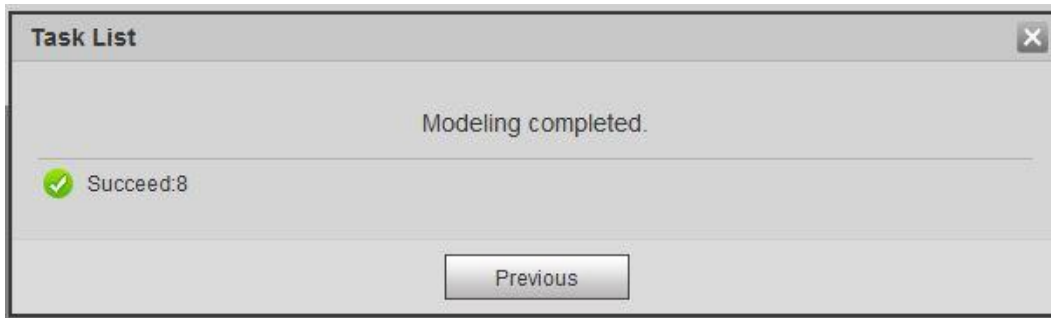

Figure 5-41 Successful modeling



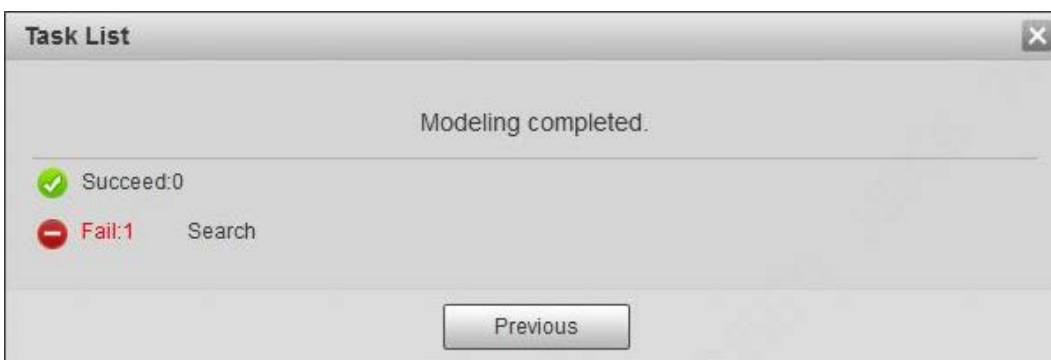

- For failed modeling, see Figure 5-42.

Figure 5-42 Failed modeling



Click Search, and the face details are displayed. Click  to view the face picture in list format. See Figure 5-43. Click  to view the face picture in thumbnail format. See Figure 5-44.

- ◇ When the modeling status is **Valid** in the list or  is displayed on the left corner of the thumbnail, it means the modeling succeeded.
- ◇ When the modeling status is **Invalid** in the list or  is not displayed on the left corner of the thumbnail, it means the modeling failed. Point to the modeling status in the list or the pictures without  to view the details of the failure.

Change the pictures according to the details.

Figure 5-43 Modeling status (list)



Figure 5-44 Modeling status (thumbnail)



5.10.3 Setting Face Recognition Alarm Linkage

When face recognition succeeded or failed, the device links alarm out.

Step 1 Select **Setting > Event > Face Recognition > Alarm**.

The **Alarm** interface is displayed. See Figure 5-45.

Figure 5-45 Alarm (face recognition)

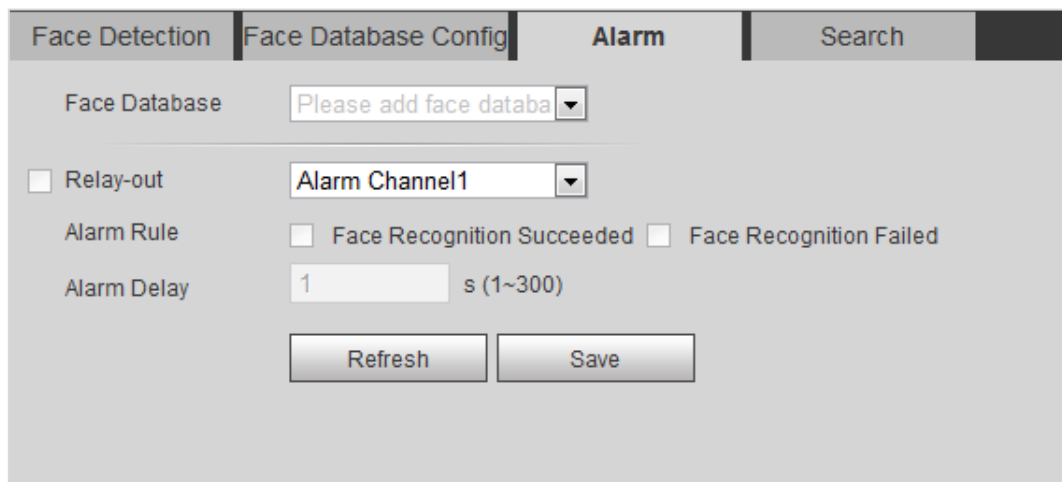

Step 2 Select a face database and an alarm rule.

- Face recognition succeeded: When the detected face matches that in the face database, the device links alarm out.
- Face recognition failed: When the detected face fails to match that in the face database, the device links alarm out.

Step 3 Set alarm linkage actions. For details, see "5.1.1 Alarm Linkage."

Step 4 Click **Save**.

5.10.4 Viewing Face Recognition Result

View face recognition result on the **Live** interface or by the search function.

5.10.4.1 Viewing Result in the Live Interface

View face recognition result on the **Live** interface. See Figure 5-46.

- Face recognition result is displayed at the left side and the captured face pictures and attribute information at the right side.

- Click a face picture in the display area, and the information is displayed.

Figure 5-46 Face recognition result

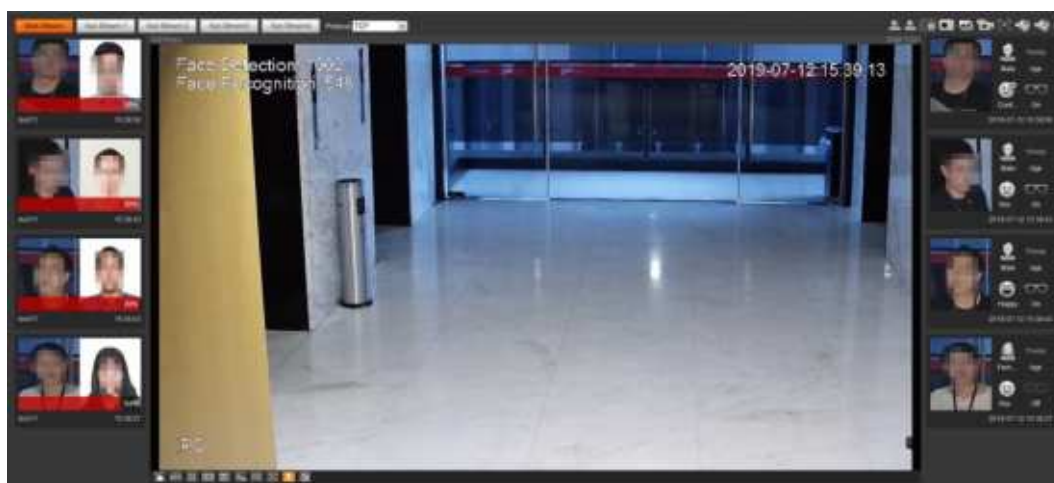

5.10.4.2 Viewing Result by Search Function

View face recognition or face snapshot result. Take face recognition search as an example.

Preparation

You have installed a SD card in the camera.

Procedure

Step 1 Select **Setting > Event > Face Recognition > Search**.

The **Search** interface is displayed. See Figure 5-47.

Figure 5-47 Face recognition search

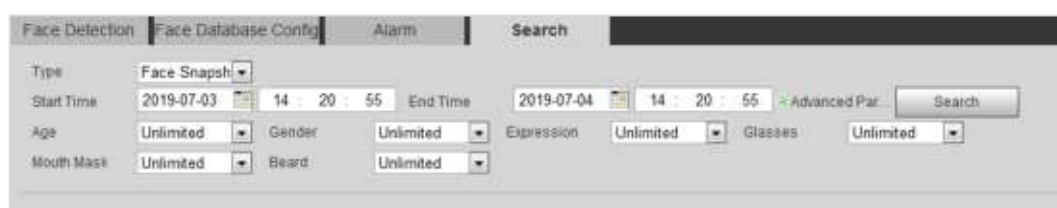

Step 2 Select **Face Recognition** for **Type**, enter the start time and the end time, and then click **Search**.

The result is displayed. See Figure 5-48.

- Click **Advanced Parameters** to set more search conditions.
- Click the search result to view details. See Figure 5-49.

Figure 5-48 Search result (face recognition)

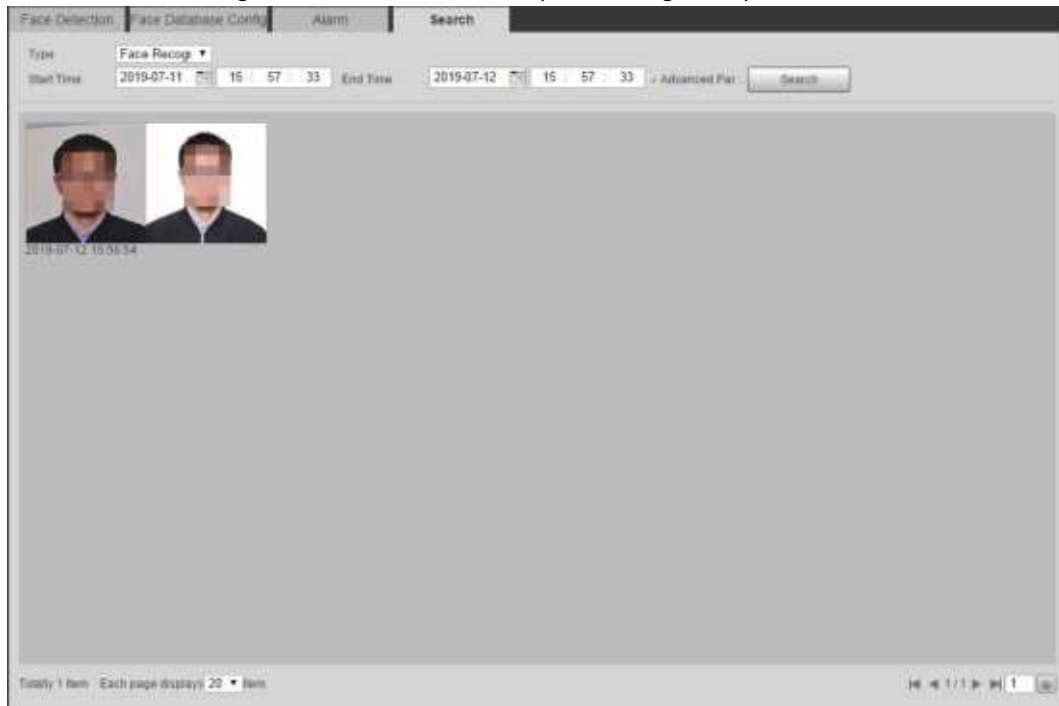
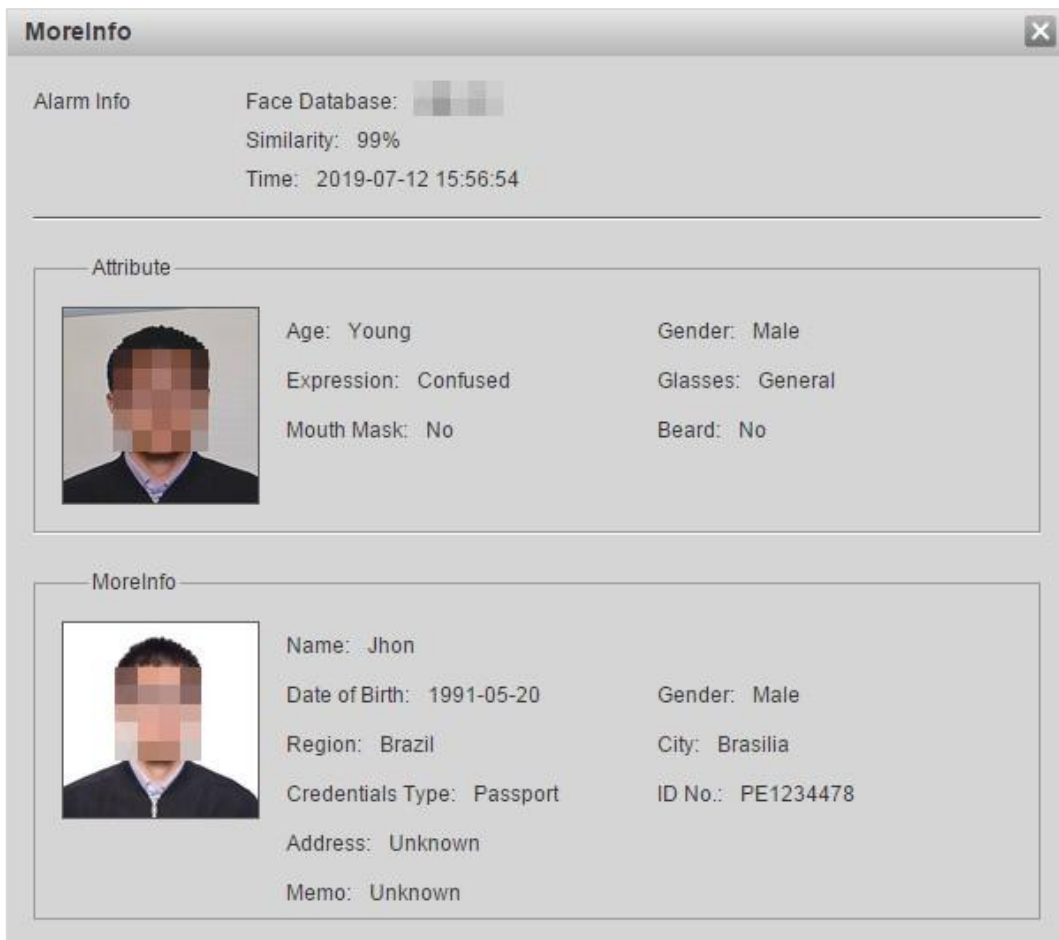

Figure 5-49 MoreInfo (face recognition)



5.11 Setting Face Detection

When a face is detected in the detection area, the system performs an alarm linkage.

Preparation

Select **Setting > Event > Smart Plan**, and then enable **Face Detection**.

Procedure

Step 1 Select **Setting > Event > Face Detection**.

The **Face Detection** interface is displayed. See Figure 5-50.

Figure 5-50 Face detection

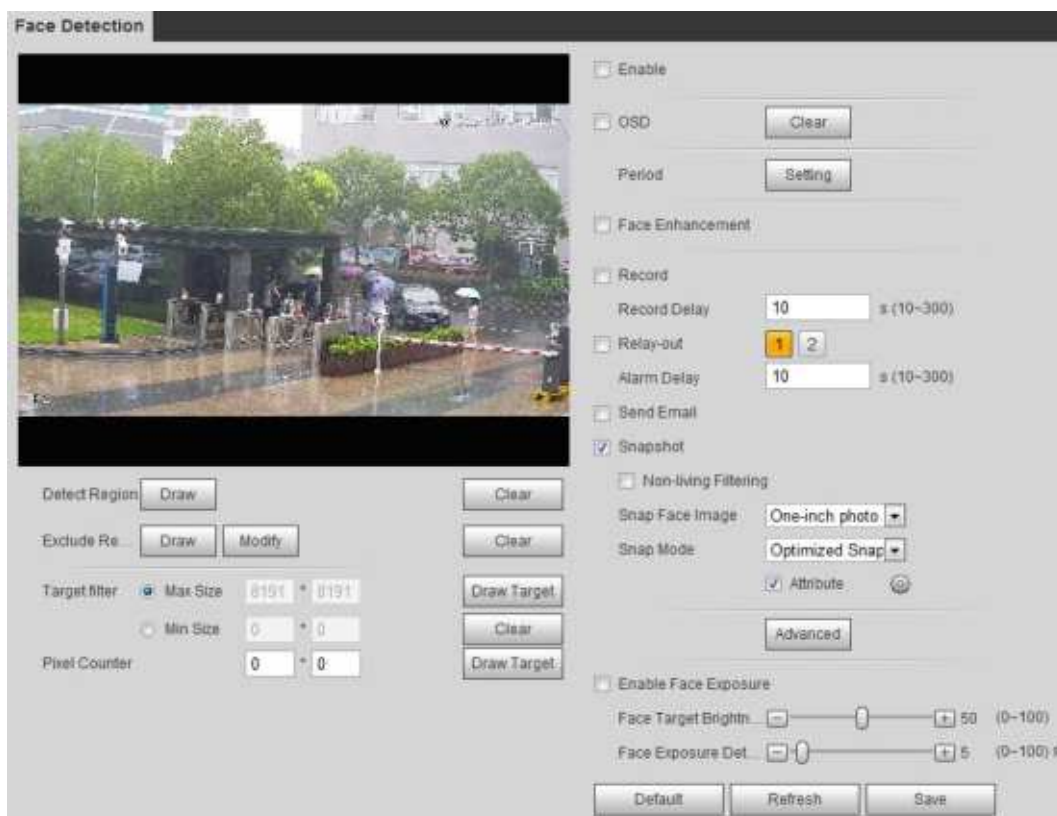

Step 2 Select the **Enable** check box to enable the face detection.

Step 3 (Optional) Click **Draw** next to **Detect Region** to draw a face detection area in the image.



Step 4 (Optional) Click **Draw** next to **Exclude Region**, and then draw an area excluding face detection in the image.

Step 5 (Optional) Select **Max Size** or **Min Size**, click **Draw Target** at the right side of **Target filter**, and then draw the target in the image.

Step 6 Set parameters. See Table 5-14.

Table 5-14 Description of face detection parameters

Parameter	Description
-----------	-------------

Parameter	Description
OSD	Select the OSD check box, and the number people with face detected and recognized is displayed on the Live interface. Click Reset to recount.
Face Enhancement	Select the Face Enhancement check box to preferably guarantee clear face with low stream.
Target Box Overlay	Select the Non-living Filtering check box to add a target box to the face in the captured picture to highlight the face. The captured face picture is saved in SD card. Click the Snap Face Image tab to view the captured picture.
Non-living Filtering	Filter non-living faces in the image, such as a face picture.
Snap Face Image	Set a range for snapping face image, including face picture and one-inch picture.
Snap Mode	<ul style="list-style-type: none"> ● Optimized Snapshot: Capture the clearest picture within the configured time after the camera detects face. ● Recognition Priority: Repeatedly compare the captured face to the faces in the armed face database, and capture the most similar face image and send the event. It is recommended to use this mode in access control scene.  <p>Click Advanced to set the optimized time.</p>
Attribute	Select the Attribute check box, and click  to set the display of face attribute during the face detection.
Advanced	<ul style="list-style-type: none"> ● Snapshot Angle Filter: Set snapshot angle to be filtered during the face detection. ● Snapshot Sensitivity: Set snapshot sensitivity during the face detection. It is easier to detect face with higher sensitivity. ● Optimized Time: Set a time period to capture the clearest picture after the camera detects face.
Enable Face Exposure	Select the Enable Face Exposure check box. When a face is detected, the camera can enhance brightness of the face to make the face image clear.
Face Target Brightness	Set the face target brightness. It is 50 by default.
Face Exposure Detection Interval	Set the face exposure detection interval to prevent image flickering caused by constant adjustment of face exposure. It is five seconds by default.
Pixel Counter	Click Draw Target next to Pixel Counter , and then press and hold the left mouse button to draw a rectangle, the Pixel Counter then displays its pixel.

Step 7 Set arming periods and alarm linkage actions. For details, see "5.1.1 Alarm Linkage."

Step 8 Click **Save**.

To view alarm information on the **Alarm** tab, subscribe relevant alarm event. For details, see "5.1.2 Subscribing Alarm."

Verification

The face detection result is displayed on the live interface. See Figure 5-51.

- The face pictures snapped in real time and their attribute information is displayed.
- Click a face picture in the display area, and the details are displayed.

Figure 5-51 Face detection result

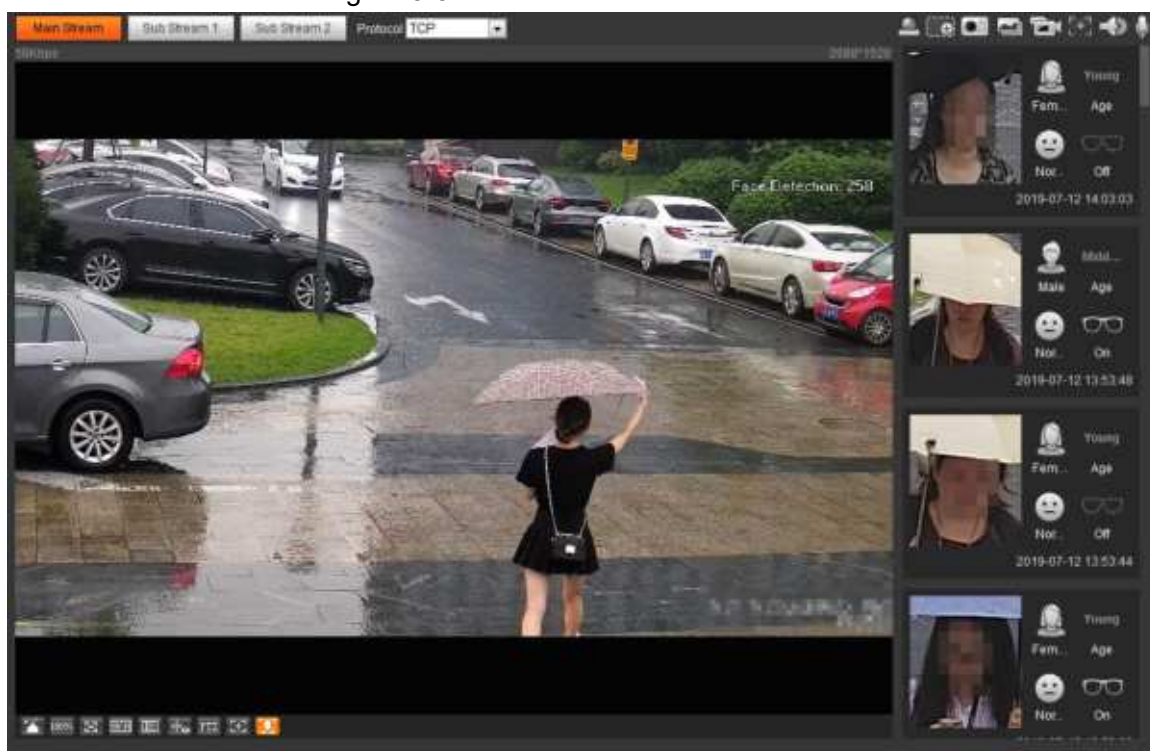

5.12 Setting People Counting

Make statistics on people flow (including enter number, leave number and people number in area), and view the people counting data in report form.

5.12.1 People Counting

The system counts the people flow entering and leaving the detection area. When the counted people flow exceeds the configured value, the system performs an alarm linkage.

Preparation

Select **Setting > Event > Smart Plan**, and then enable **People Counting**.

Procedure

Step 1 Select **Setting > Event > People Counting**.

The **People Counting** interface is displayed. See Figure 5-52 and Figure 5-53.

Figure 5-52 People counting

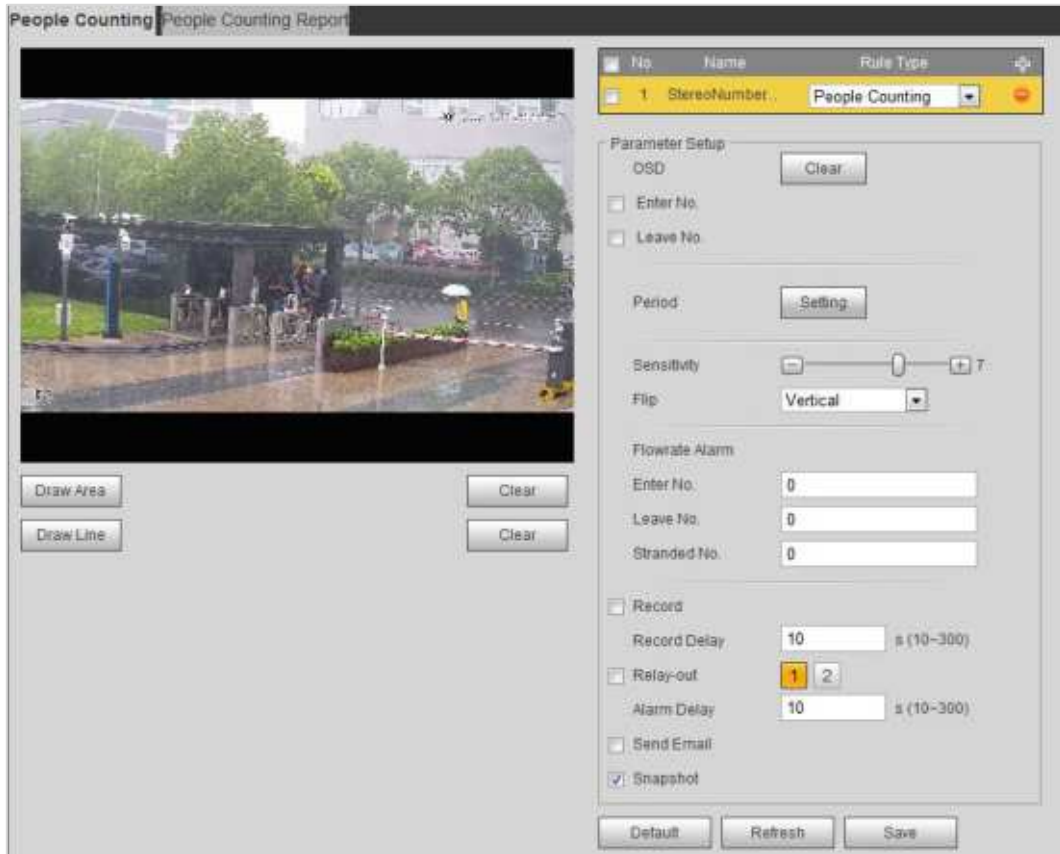
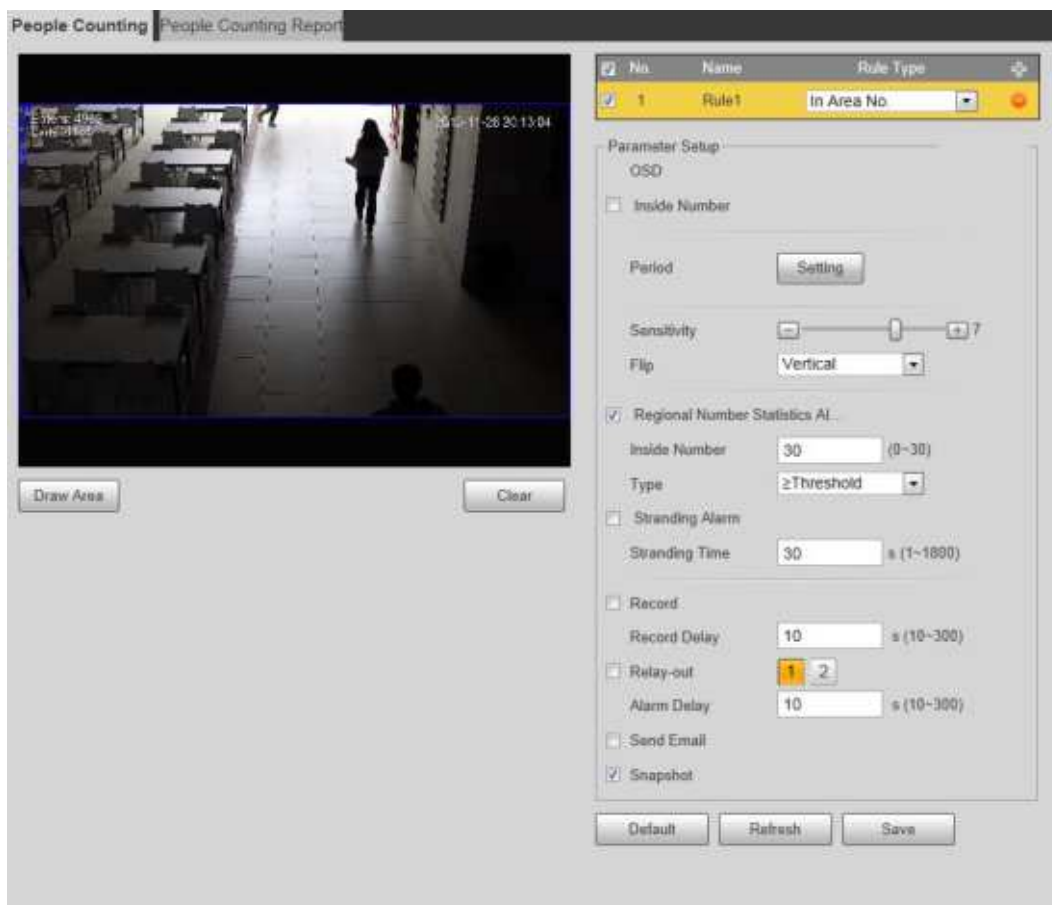

Figure 5-53 In area No.



Step 2 Click to add the people counting function.

Step 3 Double-click the name to modify the rule name. Select **People Counting** or **In Area No.**

- **People Counting:** The system counts the people flow entering and leaving the detection area. When the counted number of people who enter, leave, or stay in the area exceeds the configured value, the system performs an alarm linkage.
- **In Area No.:** The system counts the people flow in the detection area and the duration that people stay in the area. When the counted number of people in the detection area or the stay duration exceeds the configured value, the system performs an alarm linkage. This function is available on some select models.

Step 4 Click **Draw Area** to draw a detection area in the image.

- When setting **People Counting**, you need to draw direction lines. When targets enter or leave along the direction line, they will be counted.
- For the models that support multiple counting rules, different detection areas can be overlapped.

Step 5 Set parameters. See Table 5-15.

Table 5-15 Description of people counting parameters

Parameter	Description
OSD	Select the OSD check box or select the Enter No. or Leave No. check box under OSD to display the people counting data in the image. Click Clear to clear the count.
Flip	Set the viewing angle of the image as Inclined or Vertical .

Parameter	Description
Flowrate Alarm	Set Enter No. , Leave No. , and Stranded No. The alarm is triggered when the configured value is reached.
Regional People Number Statistics Alarm	Set the number of people in the people counting region. When the people count reaches the threshold or the stay duration exceeds the configured value, the alarm is triggered.
Inside Number	When you set inside number to be 0, and select the type to be \geq
Type	Threshold , the system will not perform the alarm linkage.
Stranding Alarm	Select the Stranding Alarm check box, and then set the stranding time, when the stay duration exceeds the configured value, the alarm will be triggered.
Stranding Time	
Sensitivity	Set the alarm-triggered sensitivity. The higher the sensitivity is, the easier the alarm will be triggered.

Step 6 Set arming periods and alarm linkage actions. For details, see "5.1.1 Alarm Linkage."

Step 7 Click **Save**.

To view alarm information on the **Alarm** tab, subscribe relevant alarm event. For details, see "5.1.2 Subscribing Alarm."

Verification

You can view the counting result on the **Live** interface. See Figure 5-54.

- For **People Counting** rule, the entry and exit numbers are displayed.
- For **In Area No.** rule, the inside number is displayed.

Figure 5-54 Counting result

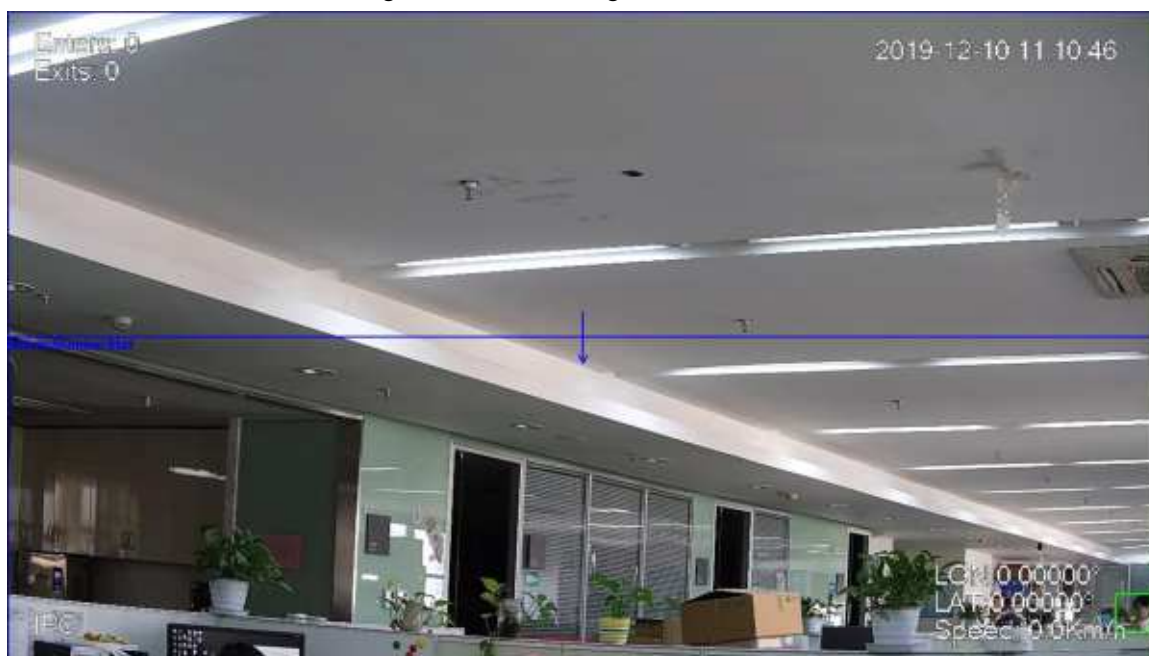

5.12.2 Queuing

The system counts the queue people in the detection area. When the queue people number exceeds the configured number or the queue time exceeds the configured time, the alarm is triggered, and the system performs an alarm linkage.

Preparation

Select **Setting > Event > Smart Plan**, and then enable **People Counting**.

Procedure

Step 1 Select **Setting > Event > Queuing**.

The **Queuing** interface is displayed. See Figure 5-55.

Figure 5-55 Queuing

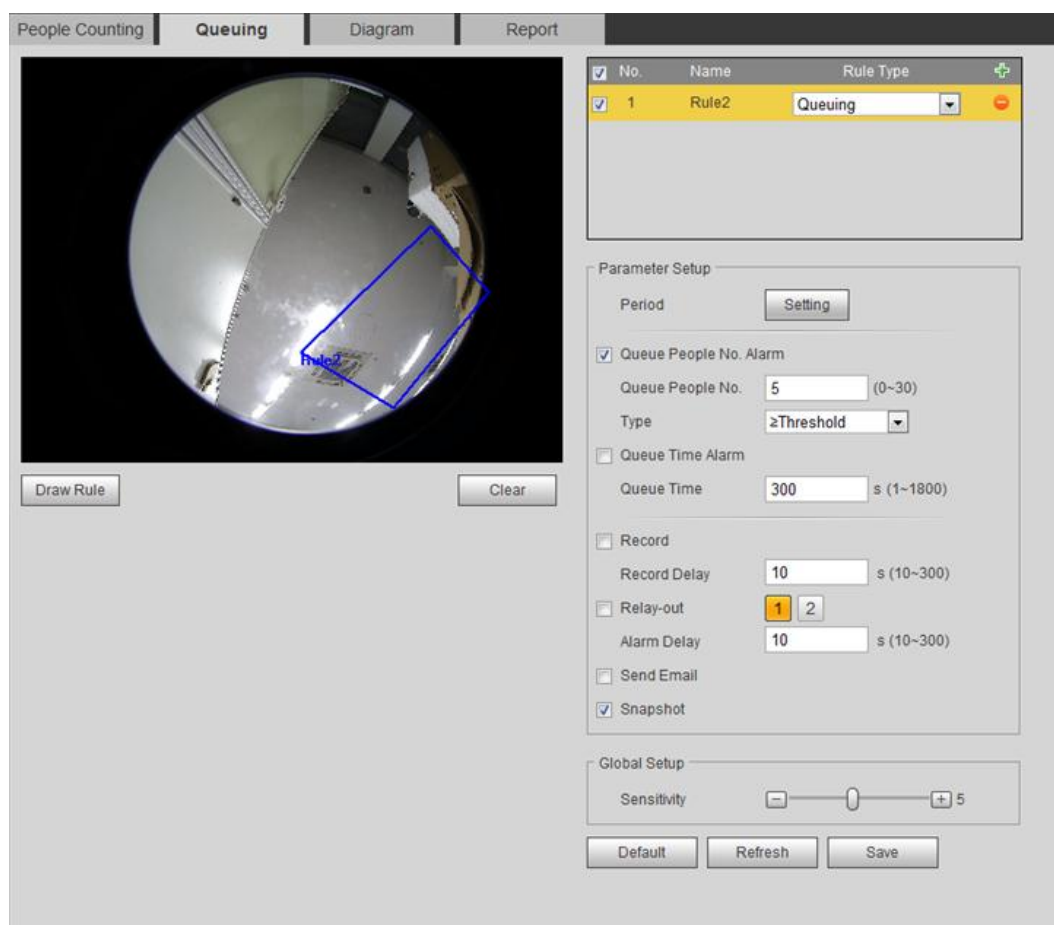

Step 2 Click  to add the queuing function.



You can add 4 rules at most.

Step 3 Double-click the name to modify the rule name. Click **Draw Rule** to draw a detection area in the image, and right-click to complete the drawing.

Step 4 Set parameters. See Table 5-16.

Table 5-16 Description of people queuing

Parameter	Description
Queue People No. Alarm	Set the queue people number for triggering the alarm and counting type. When the queue people number reaches the configured value, the alarm is triggered.
Queue People No.	
Type	
Queue Time Alarm	Set the queue time. When the queue time reaches the configured value, the alarm is triggered.
Queue Time	
Sensitivity	Set the alarm-triggered sensitivity. The higher the sensitivity is, the easier the alarm will be triggered.

Step 5 Set arming periods and alarm linkage actions. For details, see "5.1.1 Alarm Linkage."

Step 6 Click **Save**.

To view alarm information on the **Alarm** tab, subscribe relevant alarm event. For details, see "5.1.2 Subscribing Alarm."

Verification

You can view the queuing result on the **Live** interface. See Figure 5-56.

The queuing number and the stranding time of each target are displayed on the interface.

Figure 5-56 Queuing result



5.12.3 Viewing People Counting Diagram

You can search and export the heat map and tracking map according to the set searching criteria. This function is available on some Fisheye camera.

Step 1 Select **Setting > Event > People Counting > Diagram**.

The **Diagram** interface is displayed. See Figure 5-57.

Figure 5-57 Diagram

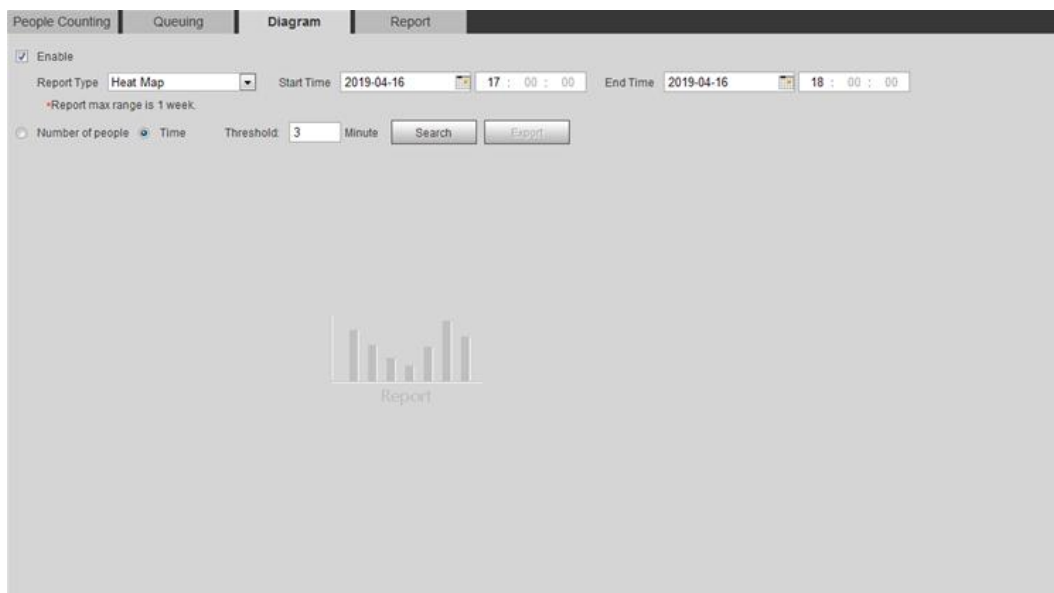

Step 2 Select the **Enable** check box to enable diagram function. And then you can search the diagram during the set period.

Step 3 Set the searching criteria. See Table 5-17.

Table 5-17 Description of searching criteria

Parameter	Description
Report Type	Select the report type from the following two types: <ul style="list-style-type: none"> ● Heat Map: Density statistics of moving object, the color range is from blue to red, blue means the minimum heat value and red means the maximum heat value. ● Track Map: Tendency statistics of moving object.
Start Time	The start time of the report.
End Time	The end time of the report.
Number of People	When selecting heat map as the report type, you can select Number of People , and set the threshold. The system searches the diagram according to the number of people in the area, and shows the heat map.
Threshold	
Time	When selecting heat map as the report type, you can select Time , and set the threshold. The system searches the diagram according to the queuing time in the area and shows the heat map..
Threshold	

Step 4 Click **Search** to complete the diagram. See Figure 5-58.

Click **Export** to export the report.

Figure 5-58 Diagram

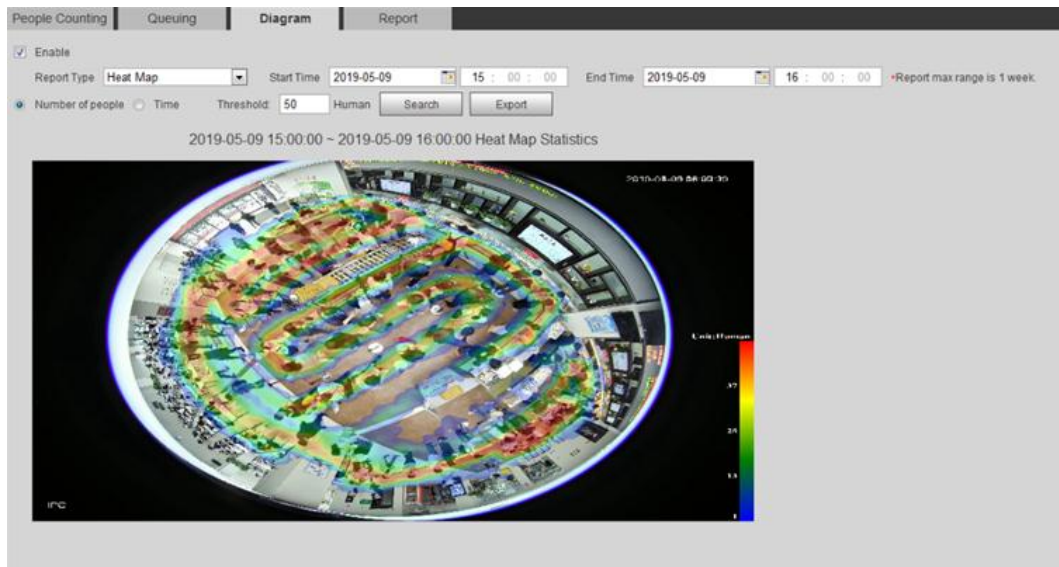

With the ruler on the right, you can read the diagram clearly.

5.12.4 Viewing People Counting Report

Generate people counting data in report form.

Step 1 Select **Setting > Event > People Counting > People Counting Report**.

The **People Counting Report** interface is displayed. See Figure 5-59.

Figure 5-59 People counting report

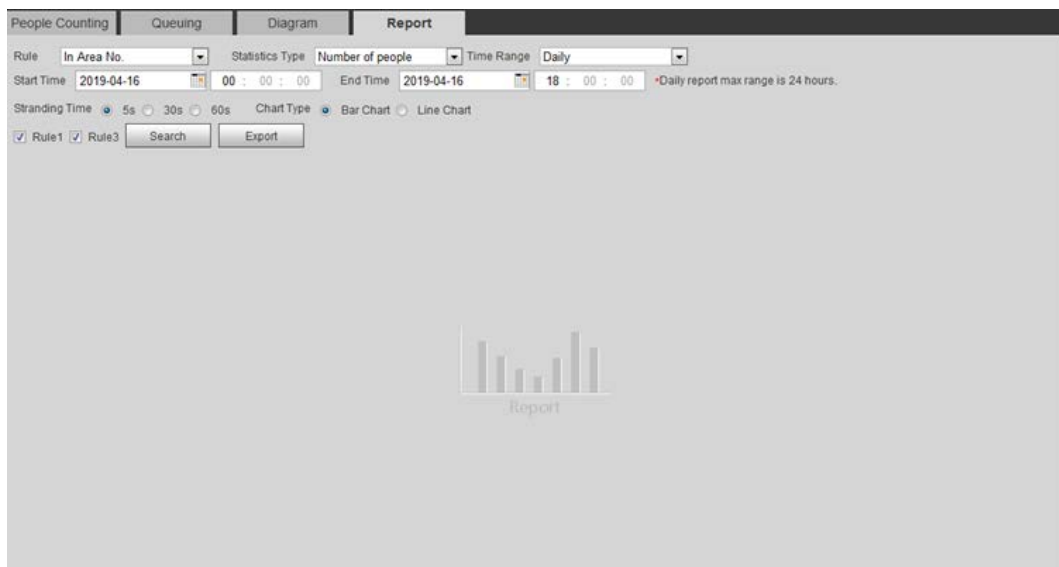

Step 2 Set search conditions. For details, see Table 5-18.

Table 5-18 Description of people counting report parameters

Parameter	Description
Rule	Select the rule of the report from In Area No and Queuing .

Parameter	Description
Statistics Type	The statistical type of people counting report. <ul style="list-style-type: none"> When you select Number of people, the system generates the report of the number of people that exceeds the configured number of people. When you select Average stranding time, the system generates the report of the average stranding time that exceeds the average stranding time.
Time Range	Select the period for the report. <ul style="list-style-type: none"> When selecting People Counting, you can view daily report, monthly report and annual report. When selecting In Area No., you can view daily report and monthly report.
Begin Time	The begin time and the end time of people counting.
End Time	
People Counting Direction	In and out directions of people counting report. You can select Entrance or Leave . Select Display Data , and the statistical quantity is displayed on the report.
Stranding Time	Count the stay time, select 5 s, 30 s, or 60 s.
Queue Time	Count the queuing time, select 1 minute, 5 minutes, or 10 minutes.
Report Type (Bar Chart/Line Chart)	Includes bar chart and line chart.
Rule 1, Rule 2...	Select the check box to search the report of the corresponding rule.

Step 3 Click **Search** to complete the report.

Click **Export** to export the report in .bmp or .csv format.

5.13 Setting Heat Map

Make statistics on the cumulative density of object movement and view heat map in report.

5.13.1 Heat Map

Detect the distribution of dynamically moving objects in the target area within a certain period and displays the distribution on a heat map. Color varies from blue to red. The lowest heating value is in blue, and the highest heating value is in red.

When mirroring occurs on the camera or the viewing angle changes, original data on the heat map will be cleared.

Preparation

Select **Setting > Event > Smart Plan**, and then enable **Heat Map**.

Procedure

Step 1 Select **Setting > Event > Heat Map > Heat Map**.

The **Heat Map** interface is displayed. See Figure 5-60.

Figure 5-60 Heat map

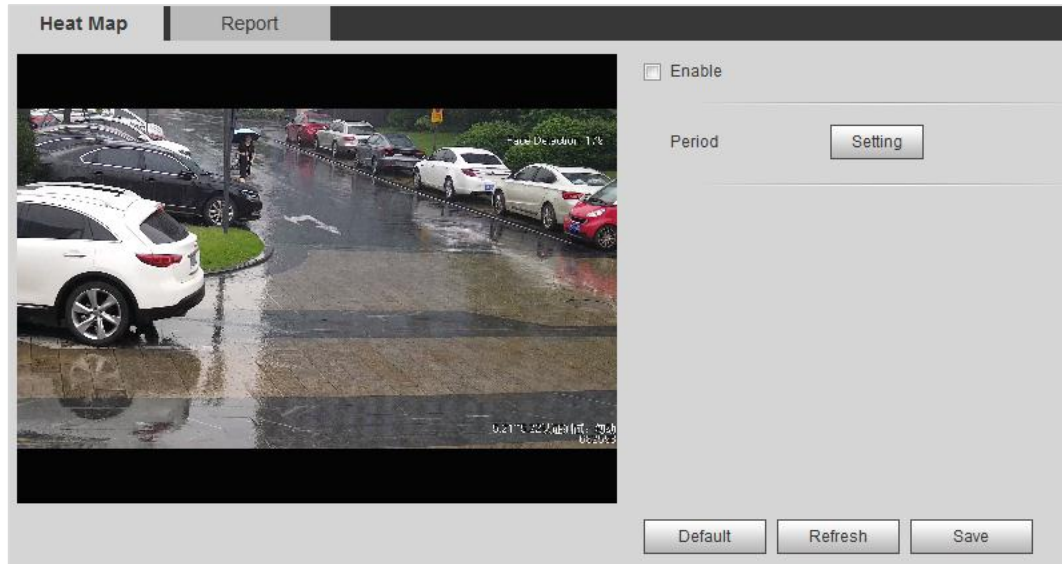

Step 2 Select the **Enable** check box to enable the heat map function.

Step 3 Set the arming period. For details, see "5.1.1.1Setting Period."

Step 4 Click **Save**.

5.13.2 Viewing Heat Map Report

The system can export heat map data as a report.

Step 1 Select **Setting > Event > Heat Map > Report**.

The **Report** interface is displayed. See Figure 5-61.

Figure 5-61 Heat map report



Step 2 Set the start time and end time.

Only some devices support heat map sequence numbers.

Step 3 Click **Search** to complete the report.

Click **Export** to export the statistical report.

5.14 Setting Stereo Analysis

Stereo analysis includes rule configuration and calibration configuration.

5.14.1 Setting Rules for Stereo Analysis

The rules for stereo analysis include **Fall Detection**, **Violence Detection**, **People No. Error**, **People Approaching Detection**, and **Strand Detection**.

For the functions and applications of the rules, see Table 5-19.

Table 5-19 Description of stereo analysis function

Rule	Function	Applicable Scene
Fall Detection	When walking or standing people in the detection area suddenly fall down on the ground, the alarm is triggered.	Park and hall
Violence Detection	When people walking or standing inside or outside the self-service hall or ATM protection cabin have violent movement (such as smashing ATM machine) or fighting, the alarm is triggered.	Bank halls and ATM protection cabins
People No. Error (Functions of People No. Error vary from devices.)	The camera can recognize the real-time number of people in the monitoring area. When the number of people exceeds the configured value, the alarm is triggered.	Scenic spots and banks
	When a recording device is used, the device that monitors the front of a classroom needs to be configured with this function. With this function, the teacher's actions can be traced and enlarged. When the number of people in the image is not 1, the whole image is displayed.	Classrooms
People Approaching Detection	When the distance between walking or standing people reaches the configured value, the alarm is triggered.	Banks and educational institutions
Strand Detection	When people in the monitoring area stay longer than the configured stranding time, the alarm is triggered.	Banks and parks

Preparation

Select **Setting > Event > Smart Plan**, and then enable **Stereo Analysis**.

Procedure

This section takes Fall Detection as an example to introduce the configuration of stereo analysis rule.

Step 1 Select **Setting > Event > Stereo Analysis > Stereo Analysis**.

The **Stereo Analysis** interface is displayed.

Step 2 Click , double-click the name to modify the rule name, and then select **People Approaching Detection** as **Rule Typ**. See Figure 5-62.

Figure 5-62 People approaching detection



Step 3 (Optional) Click **Clear** to delete the default rule box, and then click **Draw Rule** to draw a detection area in the image.

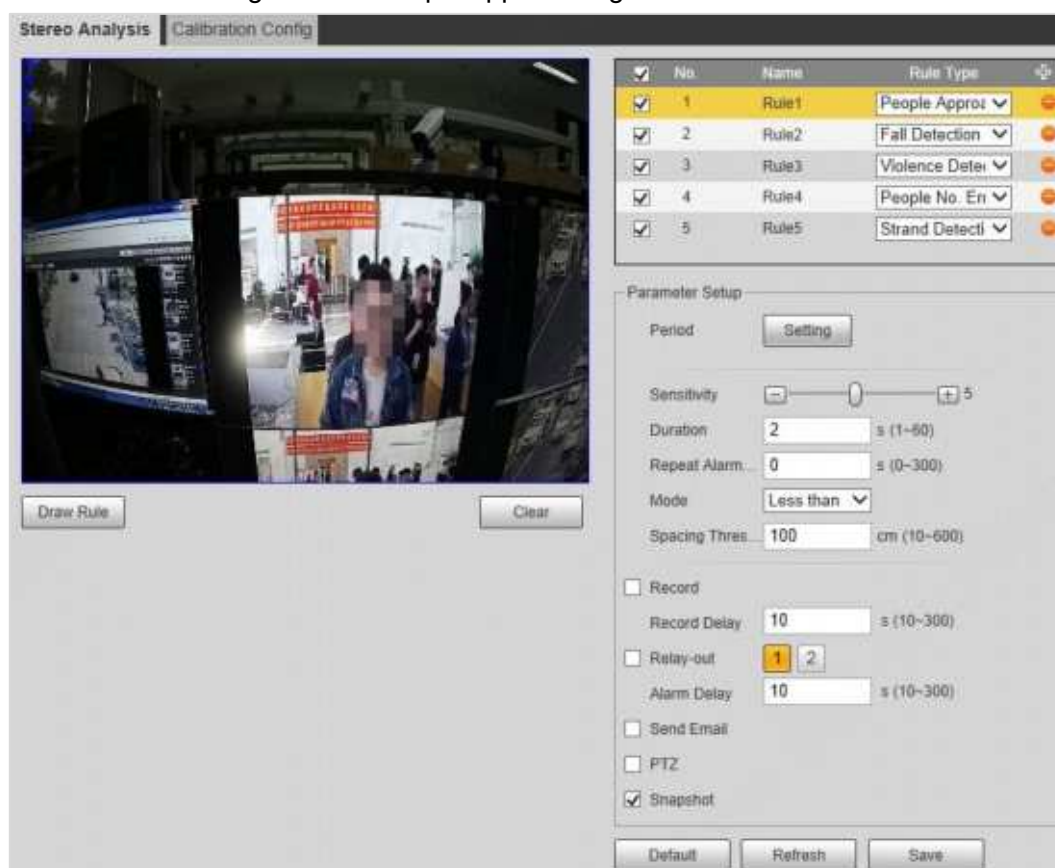

- When selecting **People No. Error** for a recording device, draw the front of a classroom as the detection area.
- When selecting **Stand Detection** for a recording device, draw the area where the students stay as the detection area.
- For other devices without special requirements, use the default box of the system (draw the full screen as the detection area).

Step 4 Set parameters. See Table 5-20.

Parameters for recording device and common device are different. The actual interface shall prevail.

Table 5-20 Description of stereo analysis parameters

Parameter	Description
-----------	-------------

Parameter	Description
Sensitivity	Set the alarm-triggered sensitivity. The higher the sensitivity is, the easier the alarm will be triggered.
Alarm People Amount	When configuring People No. Error , set the alarm people amount and alarm type. Alarm type includes Greater than , Equal to , Less than , and Unequal to .
Alarm Type	When the real-time number of people in the detection area is greater than, equal to, less than, or unequal to Alarm People Amount , the alarm is triggered.
Duration	<ul style="list-style-type: none"> For People Approaching Detection, when the time for people approaching reaches the configured value, the alarm is triggered. For Fall Detection, when the time of people falling down on the ground reaches the configured value, the alarm is triggered. For People No. Error, when the number of people in the area reaches the configured value of alarm people amount and alarm type, and the time reaches the configured value, the alarm is triggered.
Close-up Mode	<ul style="list-style-type: none"> For people No. error function for a recording device, select Tracking Mode as Close-up Mode. Then the camera traces the teacher's walking trajectory. You can view the tracking effect through sub stream 1 of the live interface. When the number of people on the image is not 1, the full screen is displayed. When setting the stand detection function for a recording device, select Fixed Mode as Close-up Mode. Then sub stream 1 enlarges and displays the image of standing people. When the number of standing people is not 1, the full screen is displayed.  <p>Before viewing the tracking or enlargement effect through sub stream 1, ensure that sub stream 1 is enabled and the resolution of the main stream and sub stream is 1080p. For configuration details of the main and sub streams, see "4.5.2.1 Video."</p>
Repeat Alarm Time	<p>After the alarm is triggered, if the status lasts for the configured time in Repeat Alarm Time, the alarm will be triggered again.</p>  <p>0 indicates that the function is disabled.</p>
Strand Time Threshold	When configuring Strand Detection, you need to set the strand time threshold. When people in the area stay longer than the configured strand time threshold, the alarm is triggered.

Step 5 Set arming periods and alarm linkage actions. For details, see "5.1.1 Alarm Linkage."

Step 6 Click **Save**.

- Select **Setting > Event > Stereo Analysis > Calibration Config** to finish calibration configuration for other devices, and then the detection rule becomes valid. For details, see "5.14.2 Calibration Configuration."
- To view alarm information on the **Alarm** tab, you should subscribe relevant alarm

event. For details, see "5.1.2 Subscribing Alarm."

5.14.2 Calibration Configuration

After configuring the rule configuration for stereo analysis, set the installation height and angle of the camera through calibration configuration.

- Calibration mode 1: Directly enter the installation height and angle according to the actual conditions.
- Calibration mode 2: Draw an area in the image to automatically calculate the installation height and the angle.

Preparation

You have set at least one rule under **Setting > Event > Stereo Analysis > Stereo Analysis**.

Procedure

Take the calibration mode 2 as an example.

Step 1 Select **Setting > Event > Stereo Analysis > Calibration Config**.

The **Calibration Config** interface is displayed. See Figure 5-63.

Figure 5-63 Calibration configuration (stereo analysis)

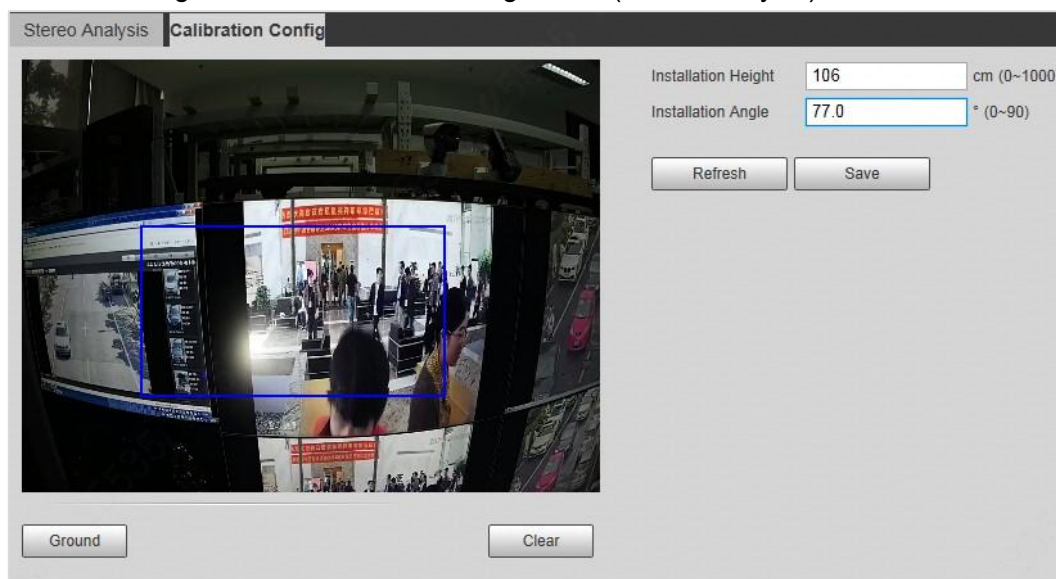

Step 2 Click **Clear** to clear the default calibration box.

Step 3 Click **Ground** to draw a rectangular box in the image.

Ground should be on the same plane and as big as possible for calibration.

Step 4 Click **Save**, and then the camera calculates its height above the ground and the angle it forms with the ground.

If the height and angle are quite different from the actual situation, repeat Step 2–Step 4.

5.15 Setting ANPR

Extract information of motor vehicles and display related attributes on the live interface.

5.15.1 Scene Configuration

Configure non-motor vehicle detection.

Preparation

Select **Setting > Event > Smart Plan**, and then enable **ANPR**.

Procedure

Step 1 Select **Setting > Event > ANPR > Scene Set**.

The **Scene Set** interface is displayed. See Figure 5-64.

Figure 5-64 Scene set (ANPR)

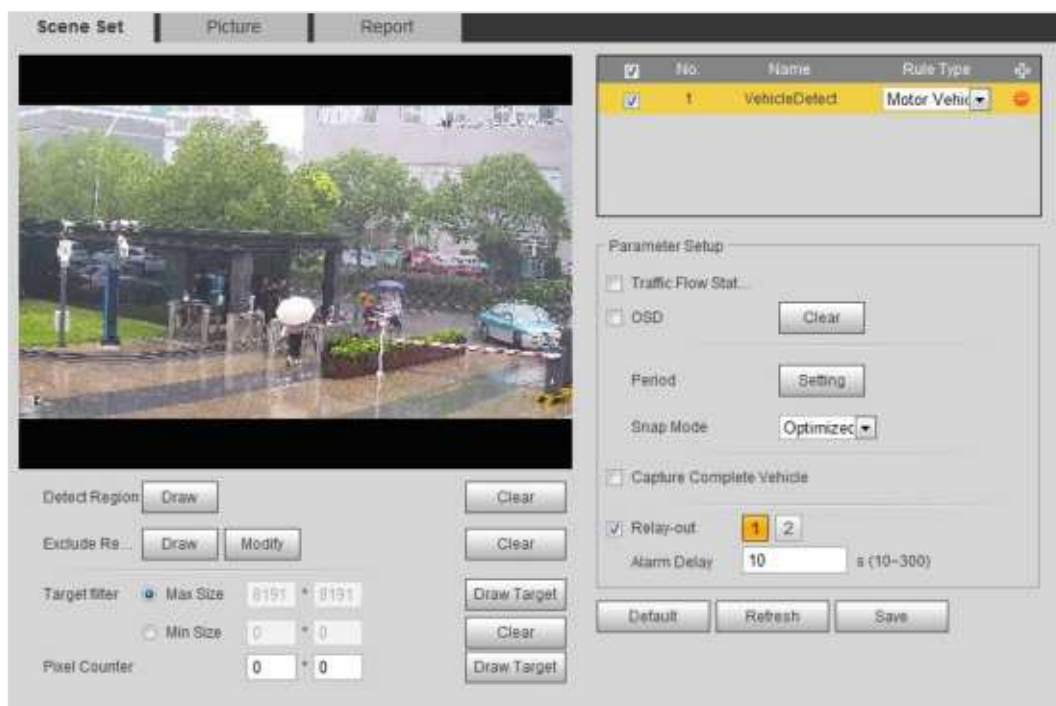

Step 2 Click **Draw** to draw a detect region and an exclude region in the image.

- Detect region: The region that needs to be detected.
- Exclude region: The region that does not need to be detected. Click **Modify** to modify the drawn region.

Click **Clear** at the right side to draw the detection area again.

Step 3 Click **Draw Target** next to **Target Filter** to draw the maximum size and minimum size for the detection target in the image.

Step 4 Configure parameters. See Table 5-21.

Table 5-21 Description of scene set parameters (ANPR)

Parameter	Description
Traffic Flow Statistics	Select Traffic Flow Stat , and the device detects the number of motor vehicles and non-motor vehicles in the detection area and generates the statistical report. If Traffic Flow Stat is disabled, the report has no statistical data.
OSD	Select OSD to display the statistical result on the preview interface. To clear the statistical result, click Clear .
Snap Mode	Select the snap mode: Optimized Snap and Tripwire .
Relay-out	Select the Relay-out check box, and when alarm is triggered, the system interacts with the linked alarm devices.
Alarm Delay	The Alarm linkage keeps running for the configured time after alarm is ended.

Step 5 Set arming periods and alarm linkage action. For details, see "5.1.1 Alarm Linkage."

Step 6 Click **Save**.

Verification

The ANPR result is displayed on the live interface. See Figure 5-65.

- The plate no. and attribute information of vehicle are displayed at the right side.
- Click the picture in the display area, and the detailed information is displayed.

Figure 5-65 ANPR result

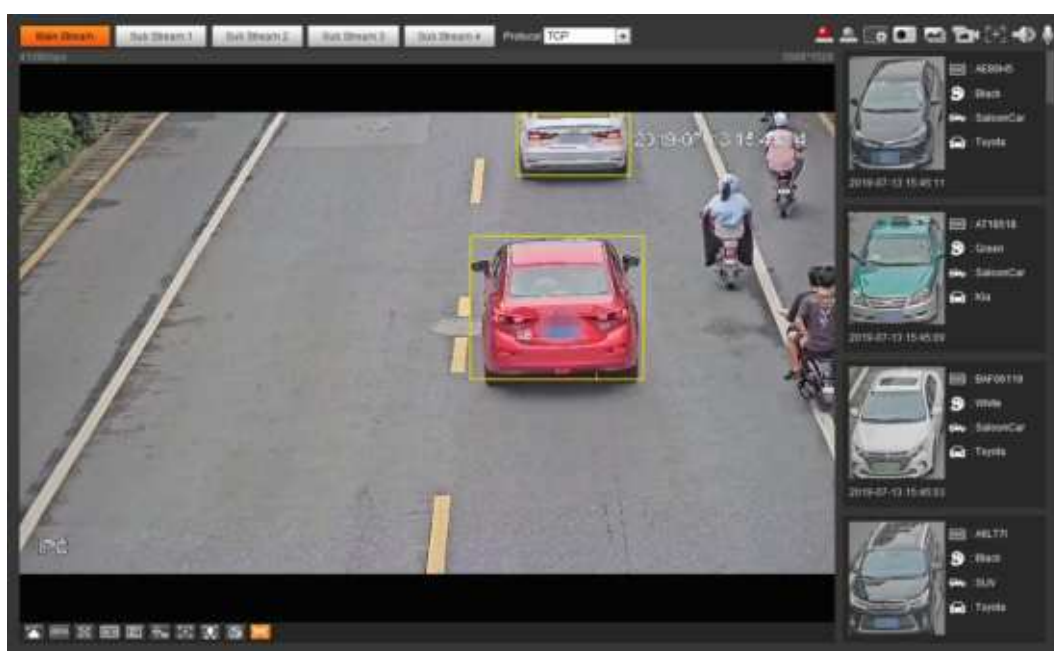

5.15.2 Setting Picture Overlay

Set overlay of motor vehicle.

Step 1 Select **Setting > Event > ANPR > Picture**.

The **Picture** interface is displayed. See Figure 5-66.

Figure 5-66 Picture (plate no. recognition)

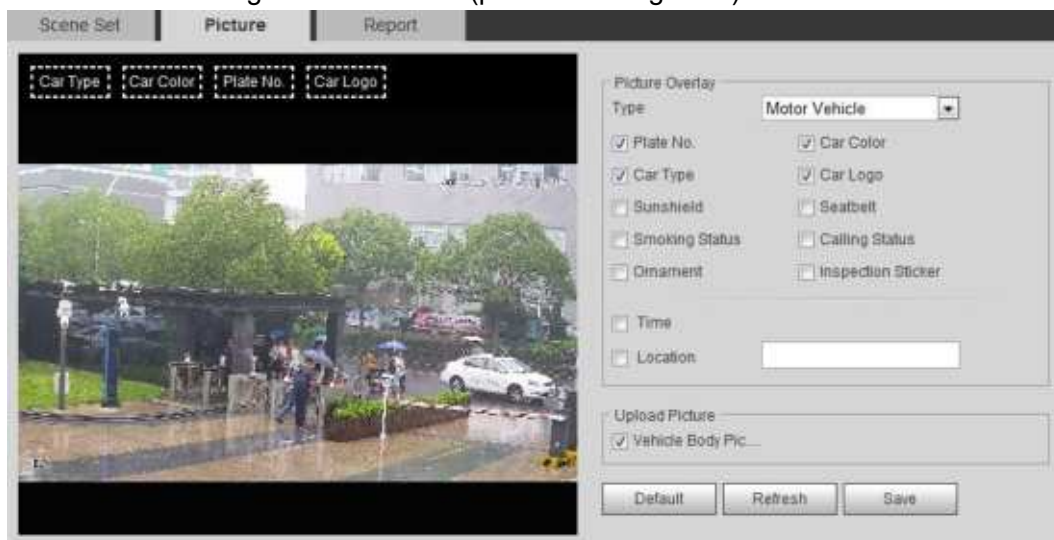

Step 2 Select **Motor Vehicle** from the **Type** drop-down list.

Step 3 Set overlay information and box position, such as plate no., time, car color, car type, and car logo.

Step 4 Click **Save**.

5.15.3 Viewing ANPR Report

Generate data of ANPR in report form.

Step 1 Select **Setting > Event > ANPR > Report**.

The **Report** interface is displayed. See Figure 5-67.

Figure 5-67 Report

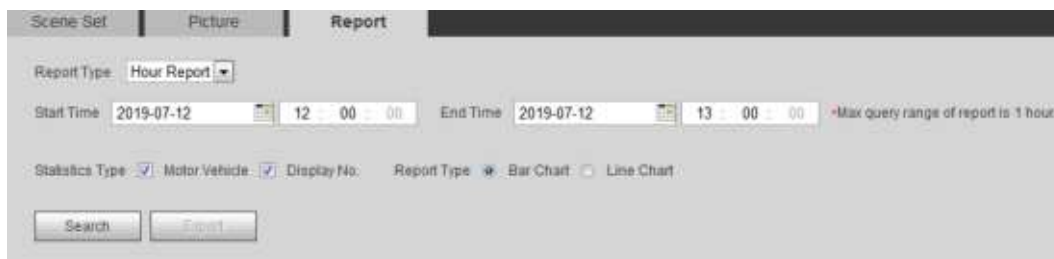

Step 2 Select the report type, start time, end time, and other parameters.

Step 3 Click **Search**.

The statistical results are displayed. See Figure 5-68. Click **Export** to export the statistical report.

Figure 5-68 Statistical results

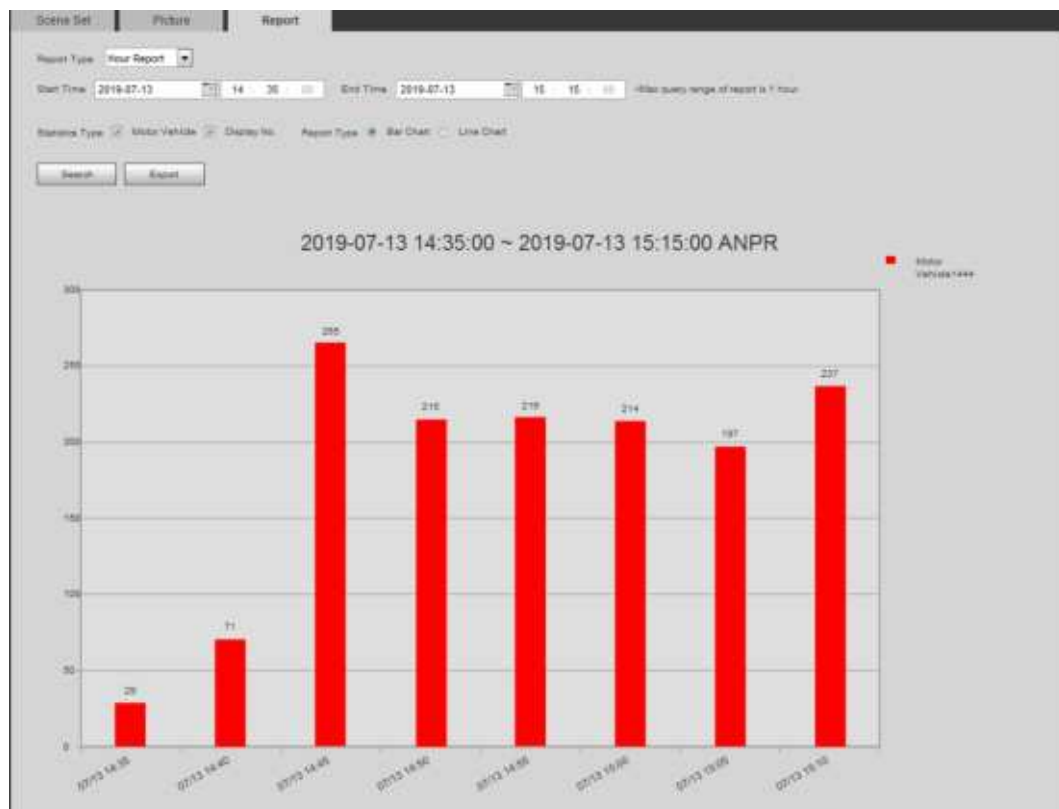

5.16 Setting Video Structuralization

Classify people, non-motor vehicles and motor vehicles in the captured video, and display the relevant attributes on the live interface.

5.16.1 Scene Configuration

Set the detection scenes and rules, including rules for people, non-motor vehicles and motor vehicles.

Preparation

Select **Setting > Event > Smart Plan**, and then enable **Video Structuralization**.

Procedure

Take setting of the People Detection rules as an example.

Step 1 Select **Setting > Event > Video Structuralization > Scene Set**.

The **Scene Set** interface is displayed. See Figure 5-69.

Figure 5-69 Scene set (video structuralization)

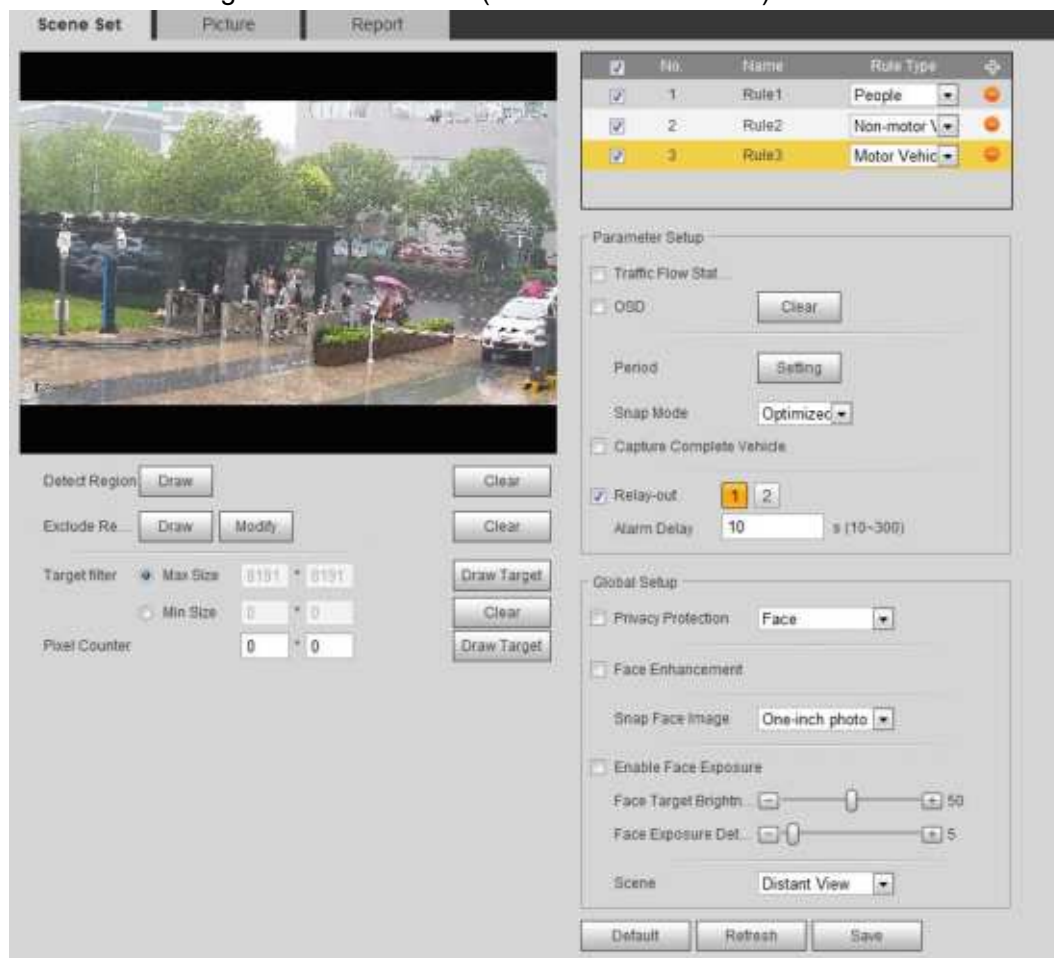

Step 2 Click , and double-click the name to modify the rule name, and select **People** in **Rule Type** list.

Step 3 Click **Draw** to draw a detect region and an exclude region in the image.

- Detect Region: The region that needs to be detected.
- Exclude Region: The region that does not need to be detected. Click **Modify** to modify the drawn region.

Step 4 Click **Draw Target** next to **Target Filter** to draw the maximum size and minimum size for the detection target in the image.

Step 5 Set parameters. For details, see Table 5-22.

Table 5-22 Description of scene set parameters (video structuralization)

Parameter	Description
People Flow Statistics	Select the People Flow Statistics check box to count the number of people in the detection area.
Traffic Flow Stat	Select the Traffic Flow Statistics check box to count the number of motor vehicles in the detection area.
Capture whole vehicle	Select the Capture Whole Vehicle check box to capture whole vehicle. The snapshot is saved in the preset path for monitoring snapshots. For details, see "4.5.2.5 Path."

Parameter	Description
Non-motor Vehicle Flow Statistics	Select the Non-motor Vehicle Flow Statistics check box to count the number of non-motor vehicles in the detection area.
OSD	Select the OSD check box, and the numbers of motor vehicles, non-motor vehicles and people in the detection area are displayed.  Click Reset to recount.
Pixel Counter	Click Draw Target next to Pixel Counter , and then press and hold the left mouse button to draw a rectangle, the Pixel Counter then displays its pixel.
Face Enhancement	Select the Face Enhancement check box to preferably guarantee clear face with low stream.
Snap Face Image	Set a range for snapping face image, including face picture and one-inch picture.
Enable Face Exposure	Select the Enable Face Exposure check box to make face clearer by adjusting lens aperture and shutter.
Face Target Brightness	Set the face target brightness, and it is 50 by default.
Face Exposure Detection Interval	Set the face exposure detection interval to prevent image flickering caused by constant adjustment of face exposure. It s 5 seconds by default.
Scene	Set scene as Distant View or Close View .

Step 6 Set arming periods and alarm linkage actions. For details, see "5.1.1 Alarm Linkage."

Step 7 Click **Save**.

Verification



Click  on the live interface to view the detection results of video structuralization. See Figure 5-70.

- The plate no. and attributes of motor vehicle are displayed at the right side, and pictures of people and non-motor vehicles and their attributes at the bottom.
- Click the picture in the display area, and the detailed information is displayed.

Figure 5-70 Video structuralization result



5.16.2 Setting Picture Information

Set overlay of motor vehicle, non-motor vehicle and people and the box position.

This section takes the configuration of motor vehicle overlay as an example.

Step 1 Select **Setting > Event > Video Structuralization > Picture**.

The **Picture** interface is displayed. See Figure 5-71.

Figure 5-71 Picture (video structuralization)

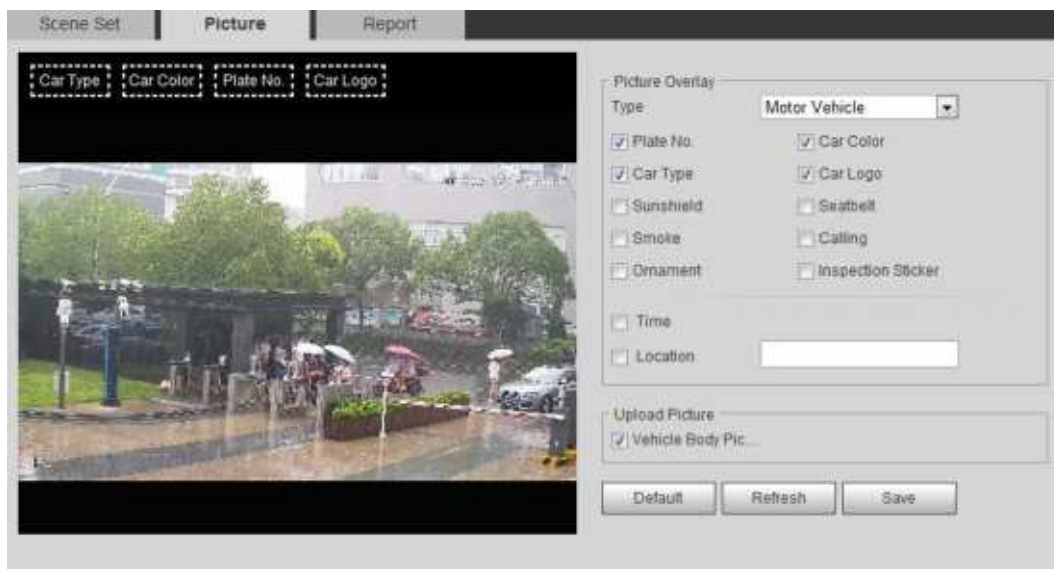

Step 2 Select **Motor Vehicle** from the **Type** drop-down list.

Select **Non-motor Vehicle** or **People**, and set non-motor vehicle and people overlay.

Step 3 Set overlay information and box position, such as plate no., time, car color, car type, and car logo.

Step 4 Click **Save**.

5.16.3 Viewing Video Structuralization Report

Generate data of video structuralization recognition in report form.

Step 1 Select **Setting > Event > Video Structuralization > Report**.

The **Report** interface is displayed.

Step 2 Select the report type, start time, end time, and other parameters.

Step 3 Click **Search** to complete the report.

The statistical results are displayed. See Figure 5-72. Click **Export** to export the statistical report.

Figure 5-72 Video structuralization report

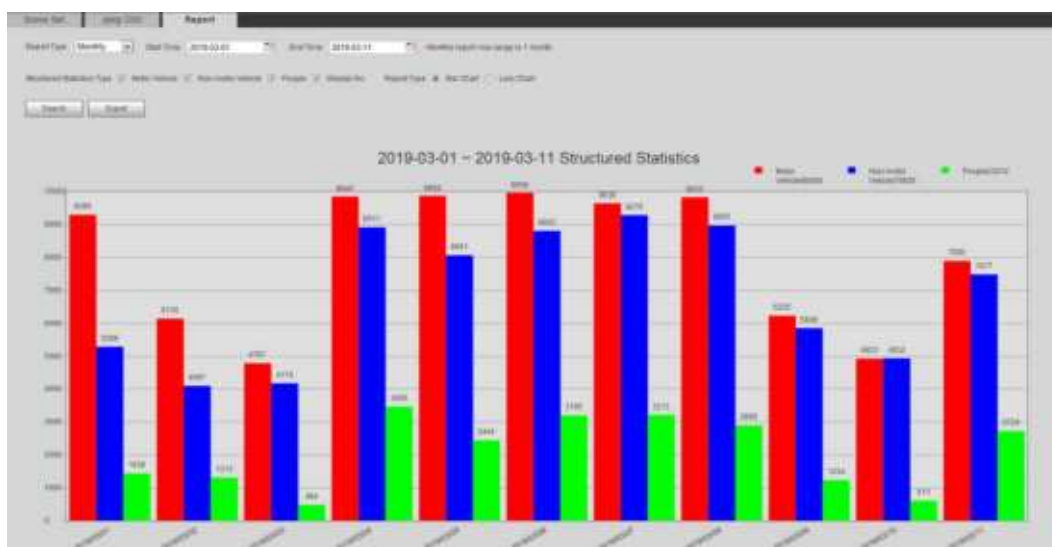

5.17 Setting Relay-in

When an alarm is triggered at the alarm-in port, the system performs alarm linkage.

Step 1 Select **Setting > Event > Alarm Settings > Alarm**.

The **Alarm** interface is displayed. See Figure 5-73.

Figure 5-73 Alarm linkage

Step 2 Select the **Enable** check box to enable the alarm linkage.

Step 3 Select a relay-in port and a sensor type.

- Sensor Type: NO or NC
- Anti-Dither: Only record one alarm event during the anti-dither period.

Step 4 Set arming periods and alarm linkage action. For details, see "5.1.1 Alarm Linkage."

Step 5 Click **Save**.

5.18 Setting Abnormality

Abnormality includes SD card, network, illegal access, voltage detection, and security exception.



Only the device with SD card has the abnormality functions, including **No SD Card**, **SD Card Error**, and **Capacity Warning**.

5.18.1 Setting SD Card

In case of SD card abnormality, the system performs alarm linkage. The event types include **No SD Card**, **Capacity Warning**, and **SD Card Error**. Functions might vary with different models, and the actual interface shall prevail.

Step 1 Select **Setting > Event > Exception Handling > SD Card**.

The **SD Card** interface is displayed. See Figure 5-74.

Figure 5-74 SD card

The screenshot shows the 'SD Card' configuration page. At the top, there are four tabs: 'SD Card', 'Network', 'Illegal Access', and 'Security Exception'. The 'SD Card' tab is active. Below the tabs, there are several settings:

- Event Type:** A dropdown menu currently showing 'No SD Card'.
- Enable:** An unchecked checkbox.
- Relay-out:** A checked checkbox.
- Alarm Delay:** A text input field containing '10' followed by 's (10~300)'. To the right of the input are two small buttons labeled '1' and '2'.
- Send Email:** An unchecked checkbox.

At the bottom of the form, there are three buttons: 'Default', 'Refresh', and 'Save'.

Step 2 Select the event type from the **Event Type** drop-down list, and then select the **Enable** check box to enable the SD card detection function.

When setting **Capacity Warning** as **Event Type**, set **Capacity Limit**. When the remaining space of SD card is less than this value, the alarm is triggered.

Step 3 Set alarm linkage actions. For details, see "5.1.1 Alarm Linkage."

Step 4 Click **Save**.

5.18.2 Setting Network

In case of network abnormality, the system performs alarm linkage. The event types include **Disconnection** and **IP Conflict**.

Step 1 Select **Setting > Event > Abnormality > Network**.

The **Network** interface is displayed. See Figure 5-75.

Figure 5-75 Network

The screenshot shows the 'Network' configuration page. At the top, there are four tabs: 'SD Card', 'Network', 'Illegal Access', and 'Security Exception'. The 'Network' tab is active. Below the tabs, there are several settings:

- Event Type:** A dropdown menu currently showing 'Disconnection'.
- Enable:** A checked checkbox.
- Record:** An unchecked checkbox.
- Record Delay:** A text input field containing '10' followed by 's (10~300)'. To the right of the input are two small buttons labeled '1' and '2'.
- Relay-out:** An unchecked checkbox.
- Alarm Delay:** A text input field containing '10' followed by 's (10~300)'. To the right of the input are two small buttons labeled '1' and '2'.

At the bottom of the form, there are three buttons: 'Default', 'Refresh', and 'Save'.

Step 2 Select the event type from the **Event Type** drop-down list, and then select the **Enable** check box to enable the network detection function.

Step 3 Set alarm linkage actions. For details, see "5.1.1 Alarm Linkage."

Step 4 Click **Save**.

5.18.3 Setting Illegal Access

When you enter a wrong login password more than the set times, the system performs alarm linkage.

Step 1 Select **Setting > Event > Abnormality > Illegal Access**.

The **Illegal Access** interface is displayed. See Figure 5-76.

Figure 5-76 Illegal access

Step 2 Select the **Enable** check box to enable the illegal access detection function.

Step 3 Set **Login Error**.

If you consecutively enter a wrong password more than the set value, the account will be locked.

Step 4 Set alarm linkage actions. For details, see "5.1.1 Alarm Linkage."

Step 5 Click **Save**.

5.18.4 Setting Voltage Detection

When the input voltage is higher than or lower than the rated value of the device, the system performs alarm linkage.

Step 1 Select **Setting > Event > Abnormality > Voltage Detection**.

The **Voltage Detection** interface is displayed. See Figure 5-77.

Figure 5-77 Voltage detection

Step 2 Select the **Enable** check box to enable the voltage detection function.
Select **Overlay**, and the alarm icon is displayed by overlapping when the alarm is

triggered.  indicates undervoltage and  indicates overvoltage.

Step 3 Set alarm linkage actions. For details, see "5.1.1 Alarm Linkage."

Step 4 Click **Save**.

5.18.5 Setting Security Exception

When a hostile attack is detected, the system performs alarm linkage.

Step 1 Select **Setting > Event > Abnormality > Security Exception**.

The **Security Exception** interface is displayed. See Figure 5-78.

Figure 5-78 Security exception

Step 2 Select the **Enable** check box to enable the security exception detection function.

Step 3 Set alarm linkage actions. For details, see "5.1.1 Alarm Linkage."

Step 4 Click **Save**.

6 Maintenance

6.1 Requirements

To make sure the system runs normally, maintain it as the following requirements:

- Check surveillance images regularly.
- Clear regularly user and user group information that are not frequently used.
- Modify the password every three months. For details, see "4.8.4 Account."
- View system logs and analyze them, and process the abnormality in time.
- Back up the system configuration regularly.
- Restart the device and delete the old files regularly.
- Upgrade firmware in time.

6.2 Auto Maintain

You can restart the system manually, and set the time of auto reboot and auto deleting old files. This function is disabled by default.

Step 1 Select **Setting > System > Auto Maintain**.

The **Auto Maintain** interface is displayed. See Figure 6-1.

Figure 6-1 Auto maintain



Step 2 Configure auto maintain parameters. For details, see Figure 6-2.

- Select the **Auto Reboot** check box, and set the reboot time, the system automatically restarts as the set time every week.
- Select the **Auto Delete Old Files** check box, and set the time, the system automatically deletes old files as the set time. The time range is 1 to 31 days.
- Click **Manual Reboot**, and then click **OK** on the displayed interface, the camera will restart.



When you enable and confirm the **Auto Delete Old Files** function, The **The deleted files cannot be restored, are you sure?** notice is displayed. Operate it carefully.

Figure 6-2 Description of auto maintain parameters



Step 3 Click **OK**.

6.3 Resetting Password

When you need to reset the password for the admin account, there will be a security code sent to the entered email address which can be used to reset the password.

Preparation

You have enabled password reset service. For details, see "4.8.5.1 System Service."

Procedure

Step 1 Open IE browser, enter the IP address of the device in the address bar and press Enter.

The login interface is displayed, see Figure 6-3.

Figure 6-3 Login



Step 2 Click **Forgot password?**

The **Prompt** dialog box is displayed. See Figure 6-4.

Figure 6-4 Prompt



Step 3 Click **OK**.

The **Reset the password (1/2)** interface is displayed, see Figure 6-5.



Clicking **OK** means that you are informed that some of your personal data might be collected to help reset the password, such as phone number, MAC address, and device serial number. Read the prompt carefully to decide whether to authorize the collection activity.

Figure 6-5 Reset the password (1)



Step 4 Reset the password.

Step 5 Scan the QR code, and there will be a security code sent to the email address you entered. Enter the security code as instructed.



- Please use the security code within 24 hours after you receive it. Otherwise, it will become invalid.
- If you fail to use the security code for two times continuously, there will be fail notice when you try to get a security code for the third time. You have to reset the device to get a security code or wait 24 hours to get it again.

Step 6 Click **Next**.

The **Reset the password (2/2)** interface is displayed, see Figure 6-6.

Figure 6-6 Reset the password (2)

Reset the password(2/2)

Username: admin

Password:

Weak Middle Strong

Use a password that has 8 to 32 characters, it can be a combination of letter(s), number(s) and symbol(s) with at least two kinds of them.
(please do not use special symbols like * ; : &)

Confirm Password:

Cancel Save

Step 7 Reset and confirm the password.

The password must consist of 8 to 32 non-blank characters and contain at least two types of characters among upper case, lower case, number, and special character (excluding ' " ; : &).

Step 8 Click **Save**.

The login interface is displayed.

6.4 Backup and Default

6.4.1 Import/Export

- Export the system configuration file to back up the system configuration.
- Import system configuration file to make quick configuration or recover system configuration.

Step 1 Select **Setting > System > Import/Export**.

The **Import/Export** interface is displayed. See Figure 6-7.

Figure 6-7 Import/Export

Import/Export

Backup Path

Import Export

Step 2 Click **Import** or **Export**.

- **Import**: Select local configuration file, and click **Open** to import the local system configuration file to the system.

- Export: Select the storage path, and click **Save** to export the system configuration file to local storage.

Step 3 Click **Save** to finish configuration.

6.4.2 Default

Restore the device to default configuration or factory settings.



This function will restore the device to default configuration or factory setting.

Select **Setting > System > Default**. The **Default** interface is displayed. See Figure 6-8.

- Click **Default**, and then all the configurations except IP address and account are reset to default.
- Click **Factory Default**, and all the configurations are reset to factory settings.

Figure 6-8 Default

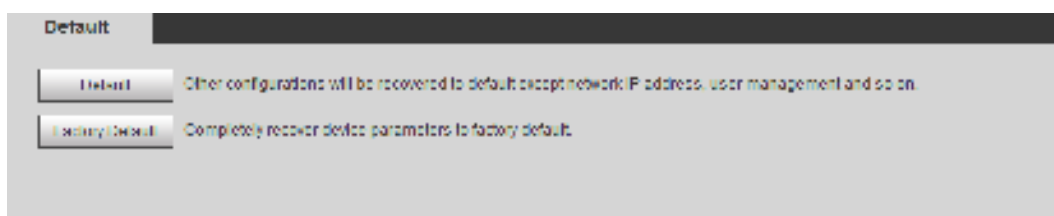

6.5 Upgrade

Upgrading to the latest system can perfect camera functions and improve stability.



If wrong upgrade file has been used, restart the device; otherwise some functions might not work properly.

Step 1 Select **Setting > System > Upgrade**.

The **Upgrade** interface is displayed. See Figure 6-9.

Figure 6-9 Upgrade

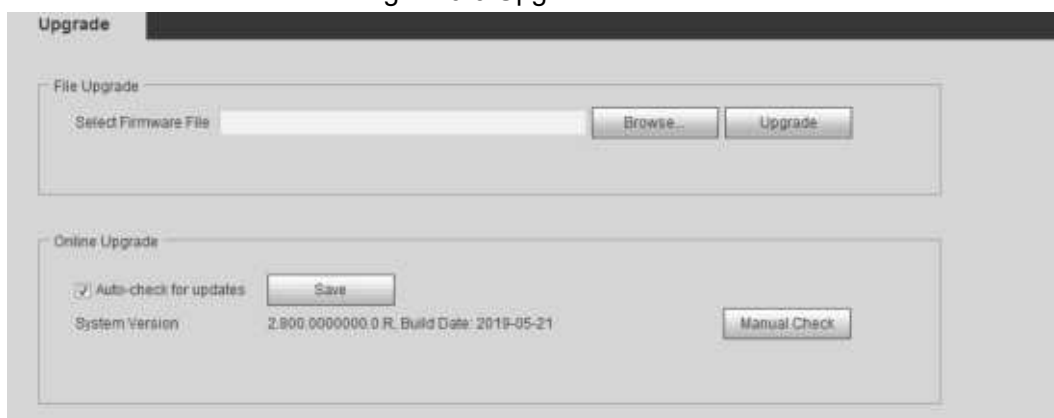

Step 2 Select upgrading method according to the actual needs.

- File Upgrade

- 1) Click **Browse**, and then upload upgrade file.
The upgrade file should be a .bin file.
- 2) Click **Upgrade**.
The upgrade starts.
- Online Upgrade
- 1) Select the **Auto-check for updates** check box.
The system checks for upgrade once a day automatically, and there will be system notice if any upgrade is available.



We need to collect the data such as device name, firmware version, and device serial number to proceed auto-check. The collected information is only used for verifying the legality of cameras and upgrade notice.

- 2) If there is any upgrade available, click **Upgrade**, and then the system starts upgrading.



Click **Manual Check** to check for upgrade manually.

6.6 Information

You can view the information, including version, log and online user, and back up or clear log.

6.6.1 Version

You can view device information such as hardware, system version, and web version.

Select **Setting > Information > Version** to view the version information.

6.6.2 Log

You can view and back up logs.

Step 1 Select **Setting > Information > Log**.

The **Log** interface is displayed. See Figure 6-10.

Figure 6-10 Log

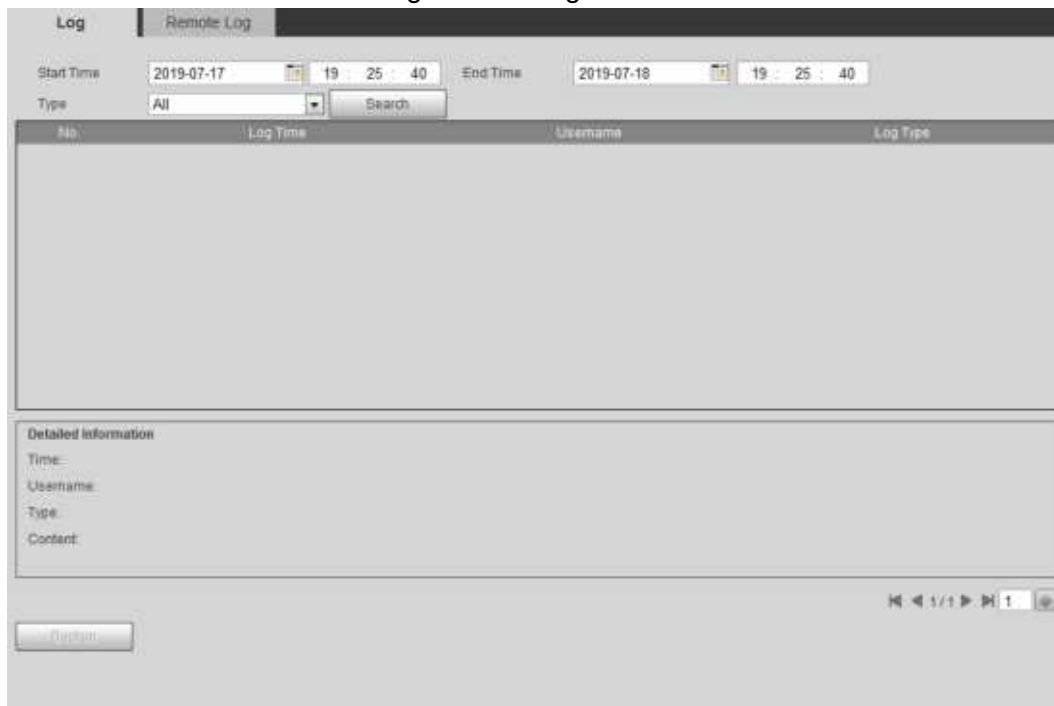

Step 2 Configure **Start Time** and **End Time**, and then select the log type.

The start time should be later than January 1st, 2000, and the end time should be earlier than December 31, 2037.

The log type includes All, System, Setting, Data, Event, Record, Account, and Safety.

- **System:** Includes program start, abnormal close, close, program reboot, device closedown, device reboot, system reboot, and system upgrade.
- **Setting:** Includes saving configuration and deleting configuration file.
- **Data:** Includes configuring disk type, clearing data, hot swap, FTP state, and record mode.
- **Event** (records events such as video detection, smart plan, alarm and abnormality): includes event start and event end.
- **Record:** Includes file access, file access error, and file search.
- **Account:** Includes login, logout, adding user, deleting user, modifying user, adding group, deleting group, and modifying group.
- **Safety:** Includes password resetting and IP filter.

Step 3 Click **Search**.

The searched results are displayed. See Figure 6-11.

- Click a certain log, and then you can view the detailed information in **Detailed Information** area.
- Click **Backup**, and then you can back up all found logs to local PC.

Figure 6-11 Log

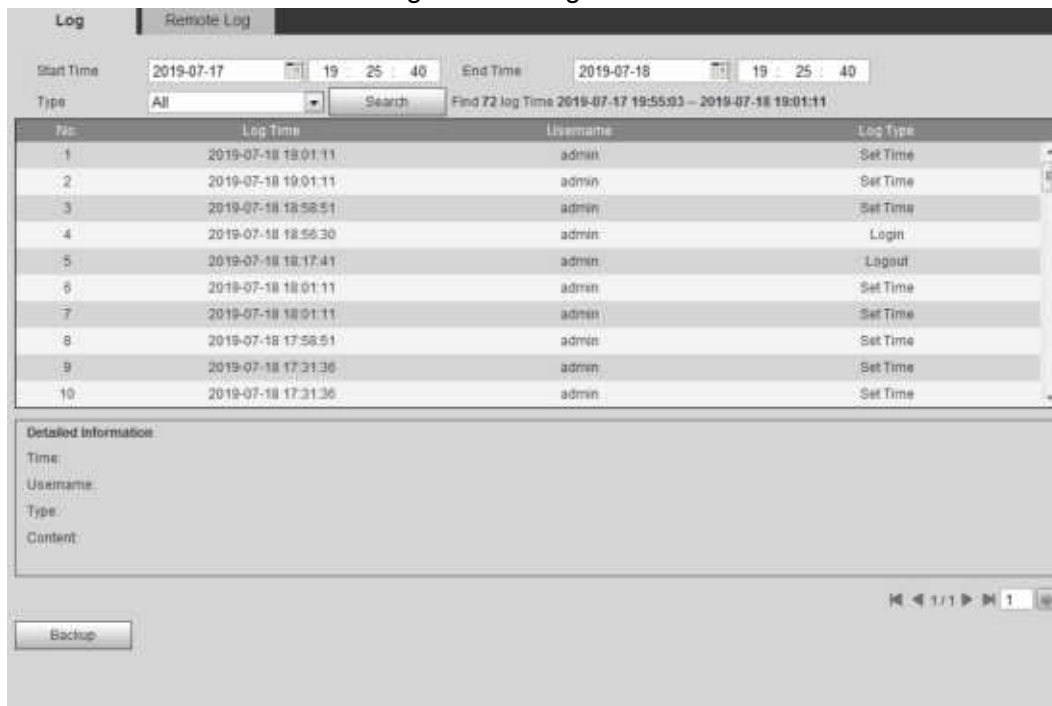

6.6.3 Remote Log

Configure remote log, and you can get the related log by accessing the set address.

Step 1 Select **Setting > Information > Remote Log**.

The **Remote Log** interface is displayed. See Figure 6-12.

Figure 6-12 Log

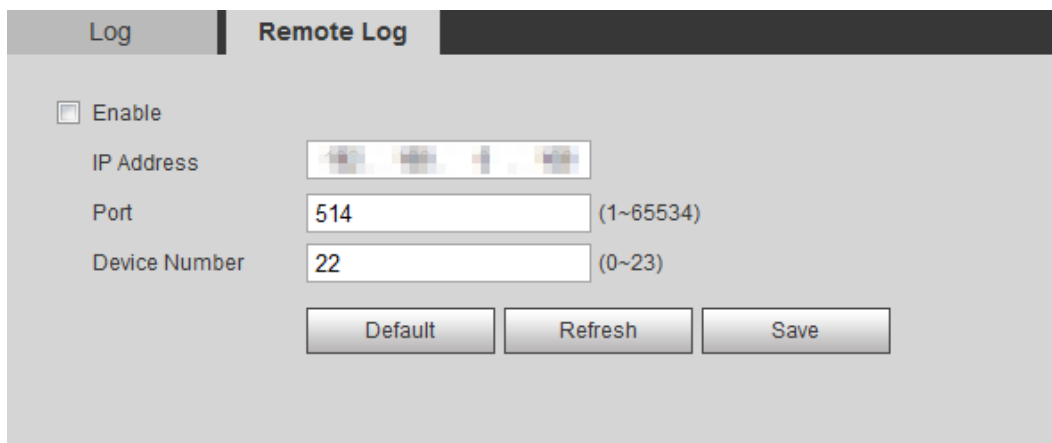

Step 2 Select the **Enable** check box to enable remote log function.

Step 3 Set address, port and device number.

Step 4 Click **Save**.

6.6.4 Online User

View all the current users logging in to web.

Select **Setting > Information > Online User**. The **Online User** interface is displayed. See Figure 6-13.

Figure 6-13 Online user



The screenshot displays a web interface titled "Online User". It features a table with the following columns: No., Username, User Local Group, IP Address, and User Login Time. A single row of data is visible, representing an active user. Below the table, there is a "Refresh" button.

No.	Username	User Local Group	IP Address	User Login Time
1	admin	admin	10.10.10.10	2020-01-14 15:02:04

Refresh

Appendix 1 Cybersecurity Recommendations

Cybersecurity is more than just a buzzword: it's something that pertains to every device that is connected to the internet. IP video surveillance is not immune to cyber risks, but taking basic steps toward protecting and strengthening networks and networked appliances will make them less susceptible to attacks. Below are some tips and recommendations on how to create a more secured security system.

Mandatory actions to be taken for basic equipment network security:

1. Use Strong Passwords

Please refer to the following suggestions to set passwords:

- The length should not be less than 8 characters;
- Include at least two types of characters; character types include upper and lower case letters, numbers and symbols;
- Do not contain the account name or the account name in reverse order;
- Do not use continuous characters, such as 123, abc, etc.;
- Do not use overlapped characters, such as 111, aaa, etc.;

2. Update Firmware and Client Software in Time

- According to the standard procedure in Tech-industry, we recommend to keep your equipment (such as NVR, DVR, IP camera, etc.) firmware up-to-date to ensure the system is equipped with the latest security patches and fixes. When the equipment is connected to the public network, it is recommended to enable the "auto-check for updates" function to obtain timely information of firmware updates released by the manufacturer.
- We suggest that you download and use the latest version of client software.

"Nice to have" recommendations to improve your equipment network security:

1. Physical Protection

We suggest that you perform physical protection to equipment, especially storage devices. For example, place the equipment in a special computer room and cabinet, and implement well-done access control permission and key management to prevent unauthorized personnel from carrying out physical contacts such as damaging hardware, unauthorized connection of removable equipment (such as USB flash disk, serial port), etc.

2. Change Passwords Regularly

We suggest that you change passwords regularly to reduce the risk of being guessed or cracked.

3. Set and Update Passwords Reset Information Timely

The equipment supports password reset function. Please set up related information for password reset in time, including the end user's mailbox and password protection questions. If the information changes, please modify it in time. When setting password protection questions, it is suggested not to use those that can be easily guessed.

4. Enable Account Lock

The account lock feature is enabled by default, and we recommend you to keep it on to guarantee the account security. If an attacker attempts to log in with the wrong password several times, the corresponding account and the source IP address will be locked.

5. Change Default HTTP and Other Service Ports

We suggest you to change default HTTP and other service ports into any set of numbers between 1024~65535, reducing the risk of outsiders being able to guess which ports you are using.

6. Enable HTTPS

We suggest you to enable HTTPS, so that you visit Web service through a secure communication channel.

7. Enable Whitelist

We suggest you to enable whitelist function to prevent everyone, except those with specified IP addresses, from accessing the system. Therefore, please be sure to add your computer's IP address and the accompanying equipment's IP address to the whitelist.

8. MAC Address Binding

We recommend you to bind the IP and MAC address of the gateway to the equipment, thus reducing the risk of ARP spoofing.

9. Assign Accounts and Privileges Reasonably

According to business and management requirements, reasonably add users and assign a minimum set of permissions to them.

10. Disable Unnecessary Services and Choose Secure Modes

If not needed, it is recommended to turn off some services such as SNMP, SMTP, UPnP, etc., to reduce risks.

If necessary, it is highly recommended that you use safe modes, including but not limited to the following services:

- SNMP: Choose SNMP v3, and set up strong encryption passwords and authentication passwords.
- SMTP: Choose TLS to access mailbox server.
- FTP: Choose SFTP, and set up strong passwords.
- AP hotspot: Choose WPA2-PSK encryption mode, and set up strong passwords.

11. Audio and Video Encrypted Transmission

If your audio and video data contents are very important or sensitive, we recommend that you use encrypted transmission function, to reduce the risk of audio and video data being stolen during transmission.

Reminder: encrypted transmission will cause some loss in transmission efficiency.

12. Secure Auditing

- Check online users: we suggest that you check online users regularly to see if the device is logged in without authorization.
- Check equipment log: By viewing the logs, you can know the IP addresses that were used to log in to your devices and their key operations.

13. Network Log

Due to the limited storage capacity of the equipment, the stored log is limited. If you need to save the log for a long time, it is recommended that you enable the network log function to ensure that the critical logs are synchronized to the network log server for tracing.

14. Construct a Safe Network Environment

In order to better ensure the safety of equipment and reduce potential cyber risks, we recommend:

- Disable the port mapping function of the router to avoid direct access to the intranet devices from external network.

- The network should be partitioned and isolated according to the actual network needs. If there are no communication requirements between two sub networks, it is suggested to use VLAN, network GAP and other technologies to partition the network, so as to achieve the network isolation effect.
- Establish the 802.1x access authentication system to reduce the risk of unauthorized access to private networks.